

®

# Makita

# 2024

SORTIMENT PRÍSLUŠENSTVA

Platnosť od 1. 4. 2024

do 30. 9. 2024



# Sortiment aku strojov do záhrady

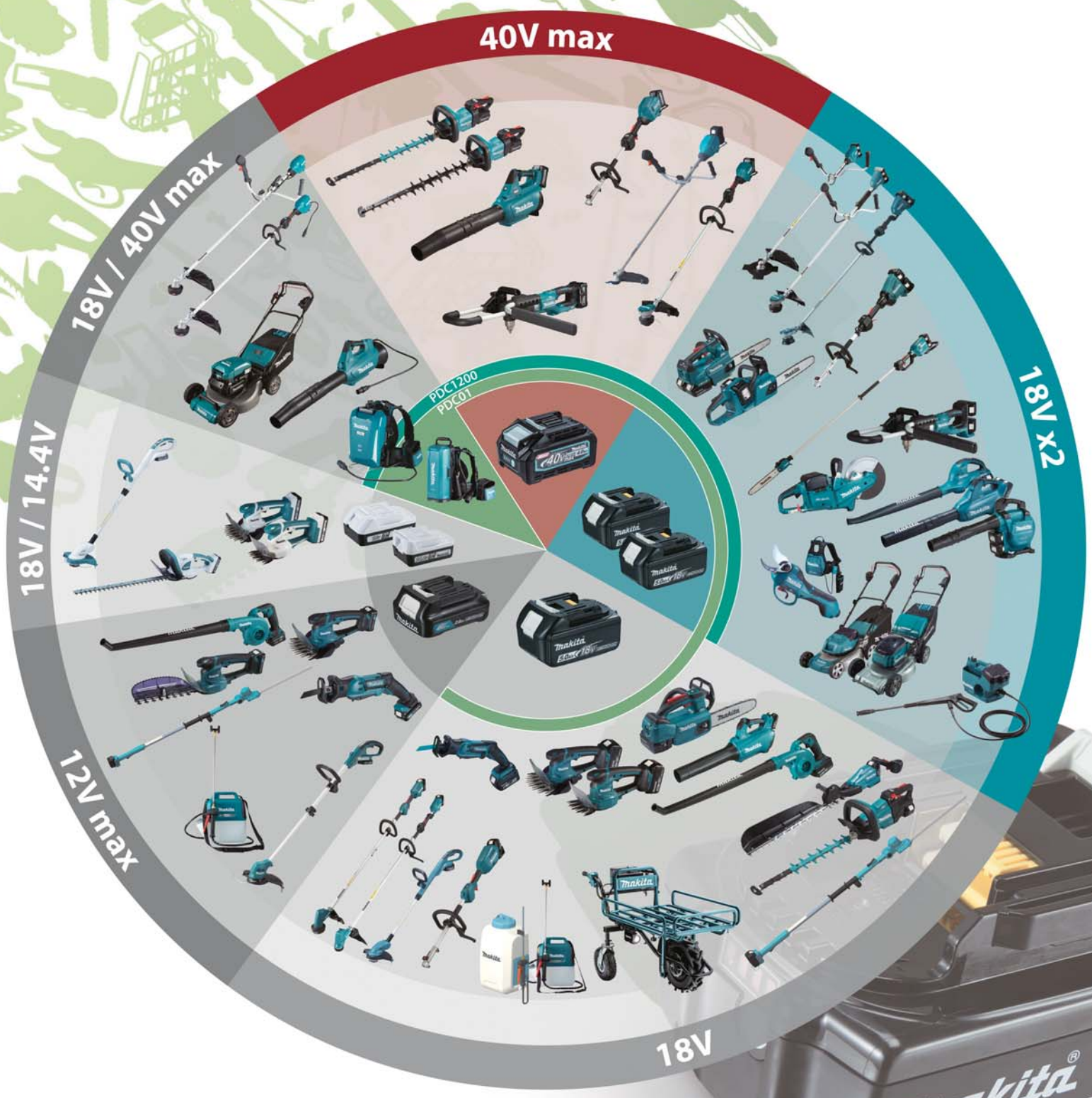

# OBSAH

Akumulátory	5 – 9	EFFICUT železo	115	Príslušenstvo pre podlahové a chrbtové aku vysávače	187 – 188
Nabíjačky, sady akumulátorov, akumulátorové adaptéry, AC adaptéry pre rádia a ventilátory		EFFICUT WPC dosky	115	Adaptéry	189
Vnútra systainerov, tašky, opasky	14 – 19	Makforce	116 – 117	Odsávacie adaptéry pre vrtacie a sekacie kladivá	190
Kov	20 – 30	Makblade	118 – 119	Pripojenie stroja k vysávačom	191 – 197
Sklo, murivo, kameň	31	Špeciálne pre aku píly	120 – 121	Teplovzdušné pištole	198
Drevo	32 – 37	Na hliník	122	Príslušenstvo pre lampy, aku kávovar	199
Vykružovacie korunky	38 – 44	Pre ponorné píly	123	Príslušenstvo pre záchranné zložky	200
Vrtáky s valcovitou stopkou betón, murivo, kameň	45 – 46	Na cementové dosky sendvičové panely	124	Záhrada	201 – 230
Príklepové vrtáky SDS-PLUS	47 – 52	Príslušenstvo pre kotúčové a pokosové píly dorazy, odsávacie adaptéry, vodiace lišty, adaptéry pre vodiace lišty	125 – 127	Ručné náradie	231 – 233
Príklepové vrtáky SDS-MAX	53 – 54	Stoly pod pokosové píly	128	Ostatné príslušenstvo spony pre kufre	234 – 237
Sekáče SDS-PLUS	55	Pílové listy	129 – 137	Uhlíky	238 – 240
Sekáče SDS-MAX	56	Príslušenstvo pre pásové píly	138		
Sady sekáčov SDS-PLUS / SDS-MAX	57	Príslušenstvo pre priamočiare píly	139		
Sekáče rôzne upínania	58	Príslušenstvo prehoblíky	140		
Príslušenstvo pre vrtacie a sekacie kladivá, rukoväte, skľučovadlá, dorazy	59	Frézky	141 – 153		
Príslušenstvo k vŕtačkám, skľučovadlá, kľúče pre skľučovadlá	60 – 65	Príslušenstvo pre frézy klieštiny, objímky	154 – 157		
Príslušenstvo pre diamantové vrtanie DBM78/128/129/228	62 – 63	Brúsne papiere	158 – 170		
Bity Impact PREMIER	66	Príslušenstvo pre DSL798/799	170		
Bity Impact BLACK	67	Príslušenstvo pre vibračné brúsky	171 – 173		
Bity, sady bitov	68 – 72	Príslušenstvo pre priame brúsky	174		
Skrutky, bity	73 – 74	Príslušenstvo pre dvojkotúčovú brúsku	175		
Príslušenstvo pre rázové uťahováky	75 – 76	Príslušenstvo pre kefovú brúsku 9,739	176		
Diamantové rezanie a brúsenie	78 – 82	Spony	177		
Príslušenstvo pre nožnice na plech, závitových tyčí a roxorov	83	Klince	178 – 180		
Rezné kotúče	84	Príslušenstvo pre DCG178, DTR178, 179			
Brúsne kotúče	85	DMP178, MP98, DGP178	181		
Lamelové kotúče	87 – 89	Príslušenstvo pre dierovač			
Fibrové kotúče	90	DPP198	182		
Príslušenstvo pre Multi Tool	91 – 102	Príslušenstvo pre nitovačky DVR148, 248	183		
Brúsne kefy	103 – 108	Aumulátorový ofukovač			
Príslušenstvo pre brúsky, príruby, kľúče, odsávacie kryty kotúčov	109 – 110	AS001G / DAS178	184		
EFFICUT drevo	114	Lasery	184		
		Príslušenstvo elektrické vysávače	185		
		Príslušenstvo pre tyčové vysávače	186		





Impact  
**PREMIER**



# PIKTOGRAMY



Drevo



Profily



Koža



Odstraňovanie farby



Drevo s klincami



Nehrdzavejúca oceľ



Vystužené vlákna



Čistý rez



Preglejka



Neželezné kovy



Vlnitý plech



Dlhá životnosť



Izolačné materiály



Bi-metal



Guma



Zvárané laserom



Laminátová podlaha



Plexisklo



Podložka



Okružná píla



Lepené drevo / škárovka



Medené rúry



Izolačný materiál



Ponorná píla



Dosky z vlákniťého cementu



PVC



Nie je vhodný pre izolačné materiály



Pokosová píla



DVD dosky



Sklo



Čistý rez



Skracovacia píla



Lepené podlahy drevené



Keramické obklady



Hrubý rez



Stolová píla



DVD dosky



Tehla



Krivý rez



Vibračná brúska



MDF



Tehla / kameň



Rovný rez



Vibračná brúska



Palety



Duté tehly



Pozdĺžny rez



Pásová brúska



Laminátová podlaha



Vápenec



Priečny rez



Benzínová rozbrusovačka



Sendvičové panely



Železobetón



Dierovaný brúsny papier



Excentrická brúska



Kov / oceľ



Betón



Brúsny papier



Uhlová brúska



Hliník



Pórobetón



Suchý zip



Delta brúska



Kov / mäkká oceľ



Polystyrén



Štetec



Uhlová brúska



1/2 BSP Fitting



5/4 UNC



Používať na sucho



Používať s vodou



Nepoužívať režim kladiva



Pre kladivá SDS-PLUS



Pre kladivá SDS-MAX

For SDS-Plus Hammers

# AKUMULÁTORY: AKUMULÁTORY, NABIJAČKY

## Akumulátory Lithium-Ion

	Model	Obj. č.	MOC s DPH		Model	Obj. č.	MOC s DPH
<b>XGT 40 V max akumulátory</b>					<b>XGT 40 V max sady akumulátorov</b>		
	BL4080F 8,0 Ah	191X65-8	349,99 €		2 x BL4050F + DC40RB	191U13-9	699,99 €
	BL4050F 5,0 Ah	191L47-8	259,99 €		2 x BL4050F + DC40RA	191V35-5	639,99 €
	BL4040 4,0 Ah	632N72-7	199,99 €		4 x BL4040 + DC40RB	191U28-6	999,99 €
	BL4040 4,0 Ah	191B26-6	209,99 €		2 x BL4040 + DC40RB	191U00-8	649,99 €
	BL4040F 4,0 Ah	1910N6-8	269,99 €		2 x BL4040 + DC40RA	191J97-1	529,99 €
	BL4025 2,5 Ah	191B36-3	159,99 €		2 x BL4025 + DC40RA	191J81-6	469,99 €
	BL4020 2,0 Ah	632R35-7	119,99 €		<b>LXT 18 V sady akumulátorov</b>		
	BL4020 2,0 Ah	191L29-0	134,99 €		4 x BL1860B + DC18RD	198091-4	649,99 €
<b>LXT 18 V akumulátory</b>					2 x BL1860B + DC18RD	198077-8	429,99 €
	BL1860B 6,0 Ah	632F69-8	109,99 €		4 x BL1850B + DC18RD	197626-8	599,99 €
	BL1850B 5,0 Ah	632F15-1	99,99 €		2 x BL1850B + DC18RD	197629-2	399,99 €
	BL1830B 3,0 Ah	632G12-3	74,99 €		8 x BL1850B	199697-1	864,99 €
	BL1820 2,0 Ah	632F01-2	72,99 €		1 x BL1830B + DC18RC	197629-2	399,99 €
	BL1815N 1,5 Ah	196235-0	63,99 €		<b>LXT nabíjačky</b>		
<b>XGT nabíjačky</b>					DC18SF štvorportová nabíjačka	196426-3	199,99 €
	DC40RB dvojportová rýchlonabíjačka	191N09-8	229,99 €		DC18RD dvojportová rýchlonabíjačka	630868-6	154,99 €
	DC40RA jednoportová rýchlonabíjačka	191E07-8	129,99 €		DC18RC jednoportová rýchlonabíjačka	195584-2	61,99 €
<b>Preносný napájací zdroj PDC1200</b>					DC18RE LXT/CXT dvojportová rýchlonabíjačka	198720-2	99,99 €
	Preносný napájací zdroj so zabudovanou batériou s kapacitou 1200 Wh, 33,5 Ah a napätím 36 V – 40 V max. Dodávané s nabíjačkou DC4001 a s adaptérom 2 x 18 V 191J51-1	PDC1200A01	1 799,99 €		DC18SE jednoportová nabíjačka do auta	194621-9	99,99 €
<b>Preносný napájací zdroj PDC1500</b>					DC18SD jednoportová nabíjačka	194533-6	59,99 €
	Preносný napájací zdroj so zabudovanou batériou s kapacitou 1.567,8 Wh, 43,55 Ah a napätím 36 V – 40 V max. Dodávané s nabíjačkou	PDC1500A01	1 999,99 €				

# AKUMULÁTORY: AKUMULÁTORY, NABÍJAČKY

## Akumulátory Lithium-Ion

	Model	Obj. č.	MOC s DPH		Model	Obj. č.	MOC s DPH
	<b>LXT14,4 V akumulátory</b>				<b>CXT 12 V max akumulátory</b>		
	BL1450 5,0 Ah	632E05-8	104,99 €		BL1041B 4,0 Ah	197406-2	64,99 €
	BL1440 4,0 Ah	196388-5	104,99 €		BL1021B 2,0 Ah	632F59-1	42,99 €
	BL1430B 3,0 Ah	197615-3	79,99 €		BL1016B 1,5 Ah	197393-5	38,99 €
	BL1415N 1,5 Ah	196875-4	59,99 €				
	<b>CXT nabíjačky</b>				<b>G – séria</b>		
	DC10SB jednoportová nabíjačka	197363-4	56,99 €	BL1815G 18 V 1,5 Ah	198186-3	54,99 €	
	<b>G – séria nabíjačka</b>			BL1415G 14,4 V 1,5 Ah	198192-8	47,99 €	
	DC18WA jednoportová nabíjačka	195423-6	33,99 €		<b>LXT 10,8 V</b>		
	<b>LXT 7,2 V</b>				BL1013 1,3 Ah	196066-7	35,99 €
	BL7010 1,3 Ah	198000-3	39,99 €		<b>LXT 7,2 / 10,8 V nabíjačka</b>		
	<b>Silikónový kryt akumulátorov</b>				DC10WA jednoportová nabíjačka	194588-1	42,99 €
	BL1016, BL1021B	413E99-0	cena na vyžiadanie		<b>Atrapy / kryty kontaktov akumulátorov</b>		
	BL1041B	413F00-1	cena na vyžiadanie		Atrapa BL1041B CXT	Z74144-2	cena na vyžiadanie
	BL1815N, BL1820B	459937-2	7,49 €		Atrapa BL1860B LXT	Z86060-0	18,99 €
	BL1830B, BL1840B, BL1850B, BL1860B	459938-0	8,19 €		Atrapa BL4040 XGT	Z74152-0	20,99 €
	BL4020, BL4025	413E96-6	cena na vyžiadanie		Kryt akumulátor XGT	412393-7	0,19 €
	BL4040	413E97-4	cena na vyžiadanie		Kryt akumulátor LXT	450128-8	0,29 €
	BL4050F	413E98-2	cena na vyžiadanie		Kryt akumulátor CXT	456128-6	0,31 €



# Akumulátory & nabíjačky

40Vmax		18V		Fast Charging DC40RA	DC40RC	DC40WA*	Fast Charging DC40RA + ADP10	DC40RC + ADP10	Fast Charging DC18RC	DC18RD*	DC18RE**	DC18SF Okrem BL1430A	DC18SD	DC18SH*	DC18SE (Automotive)	DC18WC	
<b>XGT</b>	8,0Ah BL4080F	76min.	170min.	420min.	-	-	-	-	-	-	-	-	-	-	-	-	
	5,0Ah BL4050F	50min.	85min.	260min.	-	-	-	-	-	-	-	-	-	-	-	-	
	4,0Ah BL4040F BL4040	45min.	67min.	210min.	-	-	-	-	-	-	-	-	-	-	-	-	
	2,5Ah BL4025F BL4025	28min.	38min.	130min.	-	-	-	-	-	-	-	-	-	-	-	-	
	2,0Ah BL4020	22min.	30min.	110min.	-	-	-	-	-	-	-	-	-	-	-	-	
<b>40Vmax</b> Lithium-ion																	
	<b>LXT</b>	6,0Ah BL1860B	-	-	-	40min.	85min.	55min.	1 až 2 aku 130 min.	3 až 4 aku 260 min.	130min.	160min.					
		5,0Ah BL1850B	-	-	-	35min.	70min.	45min.	110 min.	220 min.	110min.	135min.					
		4,0Ah BL1840B	-	-	-	29min.	58min.	36min.	90 min.	180 min.	90min.	110min.					
		3,0Ah BL1830B	-	-	-	22min.	42min.	22min.	60 min.	120 min.	60min.	80min.					
		2,0Ah BL1820B	-	-	-	24min.	33min.	24min.	45 min.	90 min.	45min.	55min.					
1,5Ah BL1815N		-	-	-	15min.	22min.	15min.	30 min.	60 min.	30min.	40min.						
<b>18V</b> Lithium-ion																	
		Fast Charging DC105B DC18RE**	DC10WD	PDC1200 PDC1500		DC4001	PDC01										
<b>CXT</b>	5,0Ah BL1050B	75min.	160min.														
	4,0Ah BL1041B	60min.	130min.														
	2,0Ah BL1021B	30min.	70min.														
	1,5Ah BL1016	22min.	50min.														
<b>12Vmax</b> Lithium-ion																	
					35,5Ah PDC1200		360min.										
				43,55Ah PDC1500		450min.											
				Možné použiť so 4 ks 18V LXT aku													
		DC64WA	10,8V		7,2V		DC10WA	18V		14,4V		DC18WA	DC18WB				
<b>64Vmax</b> Lithium-ion	10,0Ah BL64100	300min.	10,8V Lithium-ion		1,3Ah BL1013		50min.	18V Lithium-ion		1,5Ah BL1415G BL1815G		70 min.	80 min.				
	4,0Ah BL6440	120min.	7,2V Lithium-ion		1,5Ah BL0715		35min.	14,4V Lithium-ion		2,0Ah BL1420G BL1820G		90 min.	105 min.				

Akumulátory, Odkladacie systémy, Vrtanie, Skrutkovanie, Brúsky, Pílenie, Frézovanie, Brúsenie, Klince / spony, Špeciálne stroje, Vysávanie, Fény/lampy, Záhrada, Ručné náradie, Ostatné

# AKUMULÁTORY: ADAPTÉRY A PRÍSLUŠENSTVO

## ADAPTÉRY

<b>ADAPTÉR ADP10</b> Adaptér ADP10 XGT nabíjačky pre LXT akumulátory	<b>191C10-7</b> <b>44,99 €</b> (MOC s DPH)	<b>ADAPTÉR 18 V ADP05</b> USB ADAPTÉR 18 V LXT pre nabíjanie mobilných zariadení	<b>DECADP05</b> <b>25,99 €</b> (MOC s DPH)
<b>ADAPTÉR</b> ADP04 adaptér pre 24V	<b>193947-6</b> <b>69,99 €</b> (MOC s DPH)	<b>ADAPTÉR 2x18V na 36V BCV03</b> Adaptér 2x18V na 36V, nie je možné použiť pre akumulátory BL1815 a 36V krovinores	<b>196809-7</b> <b>95,99 €</b> (MOC s DPH)
<b>USB ADAPTÉR 12V Max CXT</b> USB ADAPTÉR 12V Max CXT pre nabíjanie telefónov	<b>ATAADP06</b> <b>29,99 €</b> (MOC s DPH)	<b>Adaptér 1 x 40 V XGT</b>	<b>191N62-4</b> <b>139,99 €</b> (MOC s DPH)
<b>ADAPTÉR 12V MAX</b> Adaptér pre vyhrievané bundy / vesty CXT 12V MAX	<b>YL00000003</b> <b>29,99 €</b> (MOC s DPH)	<b>ADAPTÉR</b> Adaptér pre PDC01, PDC1200 2x18V	<b>191J51-1</b> <b>cena na vyziadnie</b> (MOC s DPH)
<b>ADAPTÉR 18V</b> Adaptér pre vyhrievané bundy / vesty LXT 18V	<b>YL00000004</b> <b>31,99 €</b> (MOC s DPH)	<b>ADAPTÉR</b> Adaptér pre PDC01 1x18V	<b>191J50-7</b> <b>99,99 €</b> (MOC s DPH)
<b>ADAPTÉR 12V MAX</b> Adaptér pre chladiace bundy 12V MAX	<b>GM00001605</b> <b>31,99 €</b> (MOC s DPH)	<b>NABÍJAČKA DC4001</b> nabíjačka pre PDC1200	<b>1912C9-7</b> <b>229,99 €</b> (MOC s DPH)
<b>ADAPTÉR 14,4 / 18V</b> Adaptér pre chladiace bundy	<b>GM00001607</b> <b>32,79 €</b> (MOC s DPH)	<b>ADAPTÉR 40 V MAX</b> Adaptér 40 V max XGT pre nabíjanie mobilných zariadení, 2 x USB port 5,0 V / 2,1 A	<b>ADP001G</b> <b>39,99 €</b> (MOC s DPH)
<b>ADAPTÉR BTC05</b> Adaptér XGT pre tester batérií BTC04	<b>191K30-9</b> <b>79,99 €</b> (MOC s DPH)	<b>ADAPTÉR ADP12</b> Adaptér pre komunikáciu akumulátora so strojom XGT. Funkcie adaptéru: Ochrana proti krádeži, nastavenie časovača akumulátora.	<b>1910D9-2</b> <b>129,99 €</b> (MOC s DPH)

Kapacita batérie sa meria v súlade so smernicou o batériách 2006/66 / ES a predpismi EÚ 11. 3. 2010. Li-ion IEC61960.

# AKUMULÁTORY: ADAPTÉRY A PRÍSLUŠENSTVO

ADAPTÉR CXT 12V max	TD00000110	43,99 € (MOC s DPH)	ADAPTÉR LXT 18 V	TD00000111	44,99 € (MOC s DPH)
<p>Adaptér pre vyhrievané a chladiace bundy, s USB portom pre nabíjanie mobilných zariadení</p> <p>DFV210, DFJ206, DFJ207, DFJ210, DFJ211, DFJ212, DFJ213, DFJ214, DFJ216, DFJ304, DFJ305, DFJ310, DFJ311, DFJ405, DFJ407, DFJ410, DFJ411, DFJ416, CV102D, DCV202, CJ105D, CJ106D, DCJ205, DCJ206, CB100D, DCB200, DFJ212A, DFJ213A, DFJ214A, DFJ216A, DFJ312A, DFJ416A, DFV210A, DFV214A, DFV215A</p>			<p>Adaptér pre vyhrievané a chladiace bundy, s USB portom pre nabíjanie mobilných zariadení</p> <p>DFV210, DFJ206, DFJ207, DFJ210, DFJ211, DFJ212, DFJ213, DFJ214, DFJ216, DFJ304, DFJ305, DFJ310, DFJ311, DFJ405, DFJ407, DFJ410, DFJ411, DFJ416, CV102D, DCV202, CJ105D, CJ106D, DCJ205, DCJ206, CB100D, DCB200, DFJ212A, DFJ213A, DFJ214A, DFJ216A, DFJ312A, DFJ416A, DFV210A, DFV214A, DFV215A</p>		

pre model	Obj. č.	MOC s DPH
-----------	---------	-----------

## AC ADAPTÉR LAMPY, RÁDIA, VENTILÁTORY, CHLADNIČKY / OHRIEVAČE

















DMR 106, DRM 108, DMR112	SE00000101	28,99 €
DMR110, MR003G	SE00000265	22,99 €
DMR114, DMR115, MR002G, MR004G, MR006G, MR007G	SE00000679	36,99 €
DMR200, DMR202	SE00000501	14,99 €
DMR203	SE00000792	16,99 €
MR001G, DMR107, BMR100, DMR116	SE00000078	28,99 €
CF002G	TE00000442	49,99 €
DCF300	TE00000442	49,99 €
DMR300, DMR301	TC00000137	95,99 €
CF003G	TE00000793	cena na vyžiadanie
CW001G, CW003G, DCW180 DC adaptér 12 / 24 V autozásuvka	WL00000002	13,99 €
CW001G AC adaptér 220 V	WL00000122	99,99 €
CW003G, DCW180 AC adaptér 220 V	WL00000058	97,99 €
CW002G DC adaptér 12 / 24 V autozásuvka	WL00000225	cena na vyžiadanie
CW002G AC adaptér 220 V	WL00000313	106,99 €
CW004G DC adaptér 12 / 24 V autozásuvka	CE00000007	cena na vyžiadanie
CW004G AC adaptér 220 V	CE00000110	cena na vyžiadanie

## Makpac systainery

Inteligentný spôsob ukladania strojov a príslušenstva. Systém spojovacích systainerov MakPac sa skladá zo štyroch výškovo odlišných systainerov, troch systainerov na náradie, dvoch chladiacich systainerov a dvoch transportných vozíkov. Púzdra môžu byť ukladané na seba a uzamknuté spolu s uzamykacími západkami. K dispozícii sú tiež vložky pre vaše náradie a príslušenstvo.

Prepojené systainery zaberajú menej úložného priestoru a ľahko sa prepravujú na pracovisko a z neho.



MAKPAC	
<p><b>Typ 1</b> <span style="float: right;"><b>821549-5</b> <b>39,99 €</b> (MOC s DPH)</span></p> <p>396 × 296 × 105 mm PCV</p>  	<p><b>Typ 2</b> <span style="float: right;"><b>821550-0</b> <b>48,99 €</b> (MOC s DPH)</span></p> <p>396 × 296 × 157 mm PVC</p>  
<p><b>Typ 3</b> <span style="float: right;"><b>821551-8</b> <b>49,99 €</b> (MOC s DPH)</span></p> <p>396 × 296 × 210 mm PVC</p>  	<p><b>Typ 4</b> <span style="float: right;"><b>821552-6</b> <b>67,99 €</b> (MOC s DPH)</span></p> <p>396 × 296 × 315 mm PVC</p>  
<p><b>Penová vložka systainera</b> <span style="float: right;"><b>198978-0</b> <b>8,33 €</b> (MOC s DPH)</span></p> 	<p><b>Typ 4 chladiaci box</b> <span style="float: right;"><b>198253-4</b> <b>136,99 €</b> (MOC s DPH)</span></p> <p>396 × 296 × 210 mm PVC objem 18L Kompatibilné s Makpac ramenným popruhom</p>   <p>18L <span style="font-size: small;">350ml x30</span> <span style="font-size: small;">500ml x20</span> <span style="font-size: small;">2000ml x4</span></p>
<p><b>Typ 1 s organizérmí 13 ks</b> <span style="float: right;"><b>191X80-2</b> <b>87,99 €</b> (MOC s DPH)</span></p> <p>396 × 296 × 105 mm PCV</p> 	<p><b>Držiak systainera na VC4210</b> <span style="float: right;"><b>W107418357</b> <b>34,99 €</b> (MOC s DPH)</span></p> <p>Pre vysávač VC4210M</p>   
<p><b>Sada krabičiek</b> <span style="float: right;"><b>191X92-5</b> <b>17,99 €</b> (MOC s DPH)</span></p> <p>Sada krabičiek pre systainer typ 1 50 x 50 mm 1 ks 50 x 100 mm 1ks 100 x 100 mm 1 ks 100 x 150 mm 1ks 150 x 150 mm 1 ks</p>	

## MAKPAC

<p><b>Typ 3 so 4 zásuvkami</b></p> <p>396 × 296 × 210 mm</p>	<p><b>P-84311</b>    <b>214,99 €</b> (MOC s DPH)</p> 	<p><b>Typ 3 s 12 zásuvkami</b></p> <p>396 × 296 × 210 mm</p>	<p><b>P-84327</b>    <b>277,99 €</b> (MOC s DPH)</p> 
<p><b>Typ 3 so 6 zásuvkami</b></p> <p>396 × 296 × 210 mm</p>	<p><b>P-84333</b>    <b>254,99 €</b> (MOC s DPH)</p> 	<p><b>Typ 4 s 5 zásuvkami</b></p> <p>396 × 296 × 315 mm</p>	<p><b>P-84349</b>    <b>328,99 €</b> (MOC s DPH)</p> 
<p><b>Klip na kufor</b></p> <p>pre všetky typy systainerov</p>	<p><b>453974-8</b>    <b>0,76 €</b> (MOC s DPH)</p>  	<p><b>Popruh jednoramenný</b></p>	<p><b>196817-8</b>    <b>3,59 €</b> (MOC s DPH)</p>  
<p><b>Vozík pre systainer</b></p> <p>transportný vozík na štyroch otočných kolieskach, aretácia na dvoch kolieskach, klipy na zaistenie systainera</p>	<p><b>P-83886</b>    <b>137,99 €</b> (MOC s DPH)</p>  	<p><b>Typ 4</b></p> <p>vhodný pre systainery typ 1, 2, 3, 4</p>	<p><b>P-83680</b>    <b>15,99 €</b> (MOC s DPH)</p>  
	<p><b>Vozík pre systainer</b></p> <p>transportný skladací vozík s kolieskami a zaistovacím popruhom</p>	<p><b>TR0000001</b>    <b>315,99 €</b> (MOC s DPH)</p>  	
	<p><b>Taška pre RT0700</b></p> <p>410 × 350 × 310 mm odolná taška na náradie, vnútorné prepážky pre nástavce, popruh na rameno</p>	<p><b>831327-5</b>    <b>46,99 €</b> (MOC s DPH)</p> 	

# KUFRE PRE STROJE MAKITA

Obj. č.	Model	Materiál	MOC s DPH	Obj. č.	Model	Materiál	MOC s DPH
---------	-------	----------	-----------	---------	-------	----------	-----------



Kufre pre akumulátorové stroje			
824572-9	4322, 4323, 4324, 4327, 4329	PVC	23,39 €
824809-4	4350 / 4351 CT/FCT	PVC	24,99 €
193196-5	5903R	PVC	93,99 €
824985-4	9554 / 9555 / 9558 / GA4530 / 5030	PVC	24,99 €
182875-0	9557 / 9558NB kovový	PVC	23,99 €
824806-0	BO4555 / 4556 / 4565 / 4557	PVC	16,99 €
824562-2	BO5030 / 5031 / 5041	PVC	24,99 €
824757-7	BSS 610 / 611	PVC	25,99 €
158597-4	DDF / DHP / 442 / 446 / 452 / 459 / 480 / 484; DTD129	PVC	23,99 €
140354-4	DDF / DHP 441 / 454 / 453 / 454 / 456	PVC	43,99 €
141856-3	DDF083; DDF / DHP 446 / 456 / 482; DTD152 / 153 / 155; DTW181 / 190	PVC	22,99 €
158777-2	DDF343 / 453	PVC	25,99 €
821661-1	DF / HP031 / 032 / 033 / 331 / 332 / 333; TD110 / 111; TW060 / 141 / 160 / 161	PVC	14,99 €
824981-2	DF457DWE / HP457; TD126 / 127	PVC	19,99 €
141257-5	DGA450 / 452	PVC	26,99 €
821717-0	DGA700 / 701 / 900 901	PVC	55,99 €
821840-1	DGP180	PVC	59,99 €
141643-0	DHR241	PVC	34,99 €
142551-8	DHR263 / 264	PVC	70,99 €
141354-7	DJR141 / 181	PVC	28,99 €
821620-5	DJR186 / 187 / 360	PVC	32,99 €
141486-0	DJV140 / 180	PVC	30,99 €
824650-5	DP4011; HP2050 / 2051 / 2070 / 2071; HR1830 / 2020 / 2021 / 2440 / 2450	PVC	16,99 €
141353-9	DSS610 / 611	PVC	29,99 €
141205-4	DTP140; DTS13; DTW152 / 250 / 251	PVC	28,99 €
AS0VP007MK	DVP180	Hliník	116,99 €
824890-5	FS2300 / 2500 / 2700 / 2701 / 4000 / 4300 / 6300	PVC	18,99 €
824958-7	GA7020 / 7030 / 7040 / 9020 / 9030 / 9040	PVC	49,99 €
824905-8	HM0870C	PVC	66,99 €

Kufre pre akumulátorové stroje			
143519-7	HM1203C / 1205C	PVC	86,99 €
824897-1	HM1317C / CB	PVC	210,99 €
821839-6	HM1501 / 1502	PVC	113,99 €
824799-1	HR2230 / 2460 / 2470	PVC	31,99 €
821775-6	HR2300 / 2600 / 2630	PVC	46,99 €
140402-9	HR2610	PVC	30,99 €
140404-5	HR2610T	PVC	40,99 €
824789-4	HR2800/ 2810 / 2811, HK1820	PVC	22,99 €
824798-3	HR4002	PVC	44,99 €
821663-7	HS301D	PVC	24,99 €
141736-3	HS6101 / 7101	PVC	97,99 €
824555-9	HS6101, HS7101, 5603R, 5703R, 5705R	PVC	89,99 €
824964-2	HS6101, HS7101, 5603R, 5703R, 5705R	PVC	58,19 €
821796-8	JR001G	PVC	39,99 €
824993-5	JR100 / 102	PVC	19,99 €
821662-9	JR103D / 105D	PVC	24,99 €
821621-3	JR3050T / 3060T / 3070CT	PVC	21,99 €
824998-5	JV0600	PVC	17,99 €
821508-9	JV100D	PVC	21,99 €
824892-1	KP0800	PVC	16,99 €
824786-0	KP0810	PVC	54,99 €
824984-6	Kufor kombinovaný pre uhl. brúsky 230 mm /125 mm	PVC	64,99 €
821875-2	HR008G / HR009G	PVC	60,99 €

Akumulátory  
 Odkladacie systémy  
 Vrtanie  
 Skrutkovanie  
 Brúsky  
 Pilenie  
 Frézovanie  
 Brúsenie  
 Klince / spony  
 Špeciálne stroje  
 Vysávanie  
 Fény/lampy  
 Záhrada  
 Ručné náradie  
 Ostatné







# Držiaky náradia 3. generácie, technické riešenia



**Systém remienkov** na opasok s rýchlopínacími sponami na koncoch sa dajú ľahko oddeliť od tašiek na náradie a nosiť v páse ako ľahký opasok na náradie. Hodí sa na všetky vrecká a držiaky nástrojov.



**3 LAYERS**

**3L Technógia** je jedinečná trojvrstvá kombinácia polyesterov a peny, ktorá poskytuje ďalšie odpruženie. Navrhnuté tak, aby boli tvrdé a odolné voči poveternostným vplyvom. Tieto úžasne ľahké polypropylénové panely sú zložené z troch kompozitných vrstiev, ktoré sú bezpečne spojené do požadovaného tvaru. Inovatívna vlastnosť týchto štruktúrovaných materiálov umožňuje ich tvarovanie do ľubovoľného tvaru.



**WATERPROOF BOTTOM**

**Vodeodolný materiál** je vysoko kvalitné riešenie pre tašky na náradie, je pevné, odolné voči opotrebovaniu a vodotesné, takže udržuje náradie suché a chránené. Vystužený plastový podstavec vám pomôže udržiavať vak na náradie čistý.



**REAL LEATHER**

**Pravá koža** je zvonku hladká s brúseným semišom vo vnútri. Silná a odolná pre dlhú životnosť, s prídanou odolnosťou proti oderu. Koža bola vybraná pre použitie vo výrobkoch vyžadujúcich silnejšiu vrstvu – 1,8 až 2,0 mm – zabezpečenie produktu najvyššej kvality.



**DURABLE RIVETING**

**Odolné silné nitovanie.** Použité silné jednodielne nity s podložkami pre extrémne namáhané spoje. Používajú sa podložky pre väčšiu pevnosť na strategických miestach na jednej alebo na oboch stranách, hore a dole.



**ANTI SLIP**

**Istiace prvky** zabráňujú nechcenému vypadávaniu náradia s prepážok tašky a tým predchádzajú poškodeniu samotného náradia. Vysoko kvalitná polypropylénová páska má gumový povrch.



**ELASTIC LOOPS**

**Elastické popruhy**, dokonale zaisťujú náradie na svojom mieste proti svojvoľnému vypadnutiu. Elastické popruhy boli použité na širokú škálu našich produktov. Popruhy sa dokážu prispôbiť tak, aby dokonale istili náradie a príslušenstvo.



**SIDE-GATE SOLUTION**

**Klip systém**, vám umožní ľahko vložiť nástroj bez toho, aby ste sa museli pozerieť kde máte otvor držiaka náradia. Ďalšia funkcia výkyvu zaisťuje, že váš nástroj je udržiavaný v pohodlnom uhle. Vyrobené z nehrdzavejúcej ocele.









## ODKLADACIE SYSTÉMY













Foto	Popis	Rozmery (mm)			STRAP / BELT SYSTEM	3 LAYERS	WATERPROOF BOTTOM	REAL LEATHER	DURABLE RIVETING	ANTI SLIP	ELASTIC LOOPS	SIDE-GATE SOLUTION	Obj. č.	MOC s DPH
		H	L	W										
	taška na skrutkovač	290	170	85	O	O	O	O	O	O	O	E-15154	25,99 €	
	taška na skrutkovač	235	155	75	O	O	O	O	O	O	O	E-15176	17,99 €	
	univerzálna taška na skrutkovač a príslušenstvo	270	260	145	O	O	O	O	O	O	O	E-15182	49,99 €	
	2 kombinácia taška Makita	270	260	145	O	O	O	O	O	O	O	E-15198	34,99 €	
	3 kombinácia taška Makita	270	320	145	O	O	O	O	O	O	O	E-15207	45,99 €	
	univerzálna taška pre pokrivačov	270	290	145	O	O	O	O	O	O	O	E-15213	49,99 €	
	3 kombinácia taška Makita + opasok	270	640	145	O	O	O	O	O	O	O	E-15229	99,99 €	
	opasok na ťažké náradie	310	880	170	O	O	O	O	O	O	O	E-15235	124,99 €	
	taška pre elektrikárov	310	250	125	O	O	O	O	O	O	O	E-15241	35,99 €	
	taška na klince a kladivo	185	180	105	O	O	O	O	O	O	O	E-15257	22,99 €	
	taška na klince	185	175	105	O	O	O	O	O	O	O	E-15263	22,99 €	
	taška pre elektrikárov	205	185	55	O	O	O	O	O	O	O	E-15279	22,99 €	
	taška na ručné náradie a kladivo	205	185	85	O	O	O	O	O	O	O	E-15285	22,99 €	
	držiak na kladivo	165	110	65	O	O	O	O	O	O	O	E-15300	12,99 €	
	univerzálny držiak s klipom	165	110	15	O	O	O	O	O	O	O	E-15316	9,99 €	
	taška na meter	165	110	80	O	O	O	O	O	O	O	E-15338	11,99 €	



## Opasky

Foto	Popis	Rozmery (mm)			STRAP/BELT SYSTEM	3 LAYERS	WATERPROOF BOTTOM	REAL LEATHER	DURABLE RIVETING	ANTI SLIP	ELASTIC LOOPS	SIDE-GATE SOLUTION	Obj. č.	MOC s DPH
		H	L	W										
	opasok s bedrovým pásom pre ťažké náradie	100	880	30				O	O				E-15366	41,99 €
	opasok s rýchloupínacou sponou	50	1550	-									E-05337	14,99 €
	opasok na ťažké náradie	48	1380	-				O					E-15693	25,99 €
	opasok kožený čierny M	38	1130	-				O					E-05359	25,99 €
	opasok kožený čierny L	38	1330	-				O					E-05365	25,99 €
	opasok kožený hnedý M	38	1130	-				O					E-05371	25,99 €
	opasok kožený hnedý L	38	1330	-				O					E-05387	25,99 €
	popruhy na opasok E-05321, E-05175	410	520	23					O				E-15372	36,99 €
	traky Makita	-	50	-									E-05402	21,99 €

## Tašky

Foto	Popis	Rozmery (mm)			STRAP/BELT SYSTEM	3 LAYERS	WATERPROOF BOTTOM	REAL LEATHER	DURABLE RIVETING	ANTI SLIP	ELASTIC LOOPS	SIDE-GATE SOLUTION	Obj. č.	MOC s DPH
		H	L	W										
	taška na náradie	310	510	300				O		O			E-15388	106,99 €
	taška na ťažké náradie	265	505	295				O		O			E-15394	102,99 €
	taška na náradie otvorená	355	490	310				O		O			E-15403	73,99 €
	taška na náradie	250	440	240						O			E-15431	57,99 €
	taška na náradie	300	670	330				O		O			E-11782	99,99 €
	taška na náradie	380	700	360				O		O			831279-0	75,99 €
	taška na náradie	270	520	25		O				O			E-15469	79,99 €
	taška na náradie otvorená	410	260	220				O	O	O			E-15453	58,99 €
	batoh ROLL-TOP	440	330	200						O			E-15528	72,99 €
	taška na náradie ROLL-TOP	250	610	300						O			E-15540	77,99 €
	ruksak na náradie s organizérom	490	390	230				O		O			E-15481	134,99 €
	taška na píly	260	900	270				O		O			E-15512	69,99 €

## Výbava

Foto	Popis	Rozmery (mm)			STRAP BELT SYSTEM	3 LAYERS	WATERPROOF BOTTOM	REAL LEATHER	DURABLE RIVETING	ANTI SLIP	ELASTIC LOOPS	SIDE-GATE SOLUTION	Obj. č.	MOC s DPH
		H	L	W										
	puzdro na mobil	165	90	40	O	O					O		E-15556	16,99 €
	termo taška na potraviny	210	330	180		O							E-15584	29,99 €
	ochrana kolena mäkká	240	1740	30									E-15615	29,99 €
	ochrana kolena gelová	240	170	95									E-05658	42,99 €
	pracovná vesta	640	510	-							O		E-15609	65,99 €
	taška na vodiacu lištu 1,4 – 1,5 m	220	1565	45	O	O							E-05664	47,99 €
	taška na vodiacu lištu 1 m	220	1070	45	O	O							E-05670	42,99 €
	taška na vodiacu lištu 3 m	220	3050	45	O	O							E-10936	89,99 €

## Strap Belt System

### Použitie ako popruh

Unikátny STRAP Belt System s rýchloupínacími prackami na koncoch robí opasok viacúčelový. Popruh s pohodlnou mäkkou gumou ramenná podložka robí používanie pohodlnejšie. Použitie na všetky tašky a držiaky Makita.



### Použitie ako opasok

Popruh jednoducho odopnete z tašky Makita a použijete ako opasok na držiaky Makita



**STRAP BELT SYSTEM**

**Viac ako 45 produktov v rámci systému**

# VRTANIE: ŽELEZO



## HSS VRTÁKY DO KOVU

HSS-R

HSS-G

Titánové  
HSS-TIN

Kobalt  
HSS-CO

M-Force

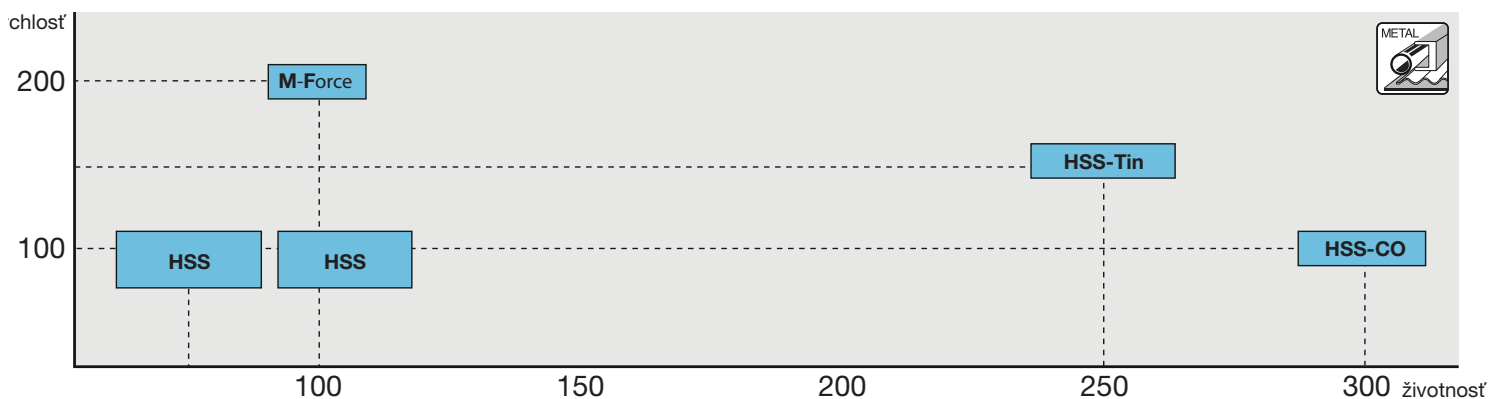

ø mm	L1 mm	L2 mm	ks/bal	Obj. č.	MOC s DPH
------	-------	-------	--------	---------	-----------

### Vrták na vrtanie otvorov pre nity



3,3	50	20	5	B-56437	9,99 €
-----	----	----	---	---------	--------

1/4 „stopkový vrták, ktorý je špeciálne navrhnutý na vrtanie otvorov pre nity. Ostrá špička pod uhlom 135 ° čo znamená, že tieto vrtáky vyvrtávajú otvory dvojnásobnou rýchlosťou ako štandardný vrták s ostrejším stredovým bodom.



### HSS-R Vrtáky do kovu z rýchloreznej ocele



Tvrdený hrot HSS-R  
Vrtáky s výbrusom vhodné pre železné a neželezné kovy, ktoré ponúkajú dobrú rýchlosť vrtania a predĺženú životnosť. Dostupné v priemeroch 1,5 mm – 13 mm



2	49	24	1	D-09662	0,79 €
3	61	33	1	D-09684	0,99 €
3,5	70	39	1	D-09690	1,29 €
4	75	43	1	D-09709	1,39 €
4,5	80	47	1	D-09715	1,59 €
5	86	52	1	D-09721	1,69 €
5,5	93	57	1	D-09737	2,09 €
6	93	57	1	D-09743	1,99 €
8,5	117	75	1	D-09793	4,39 €
10	133	87	1	D-09824	6,59 €
12	151	101	1	D-09868	9,39 €

# VŔTANIE: ŹELEZO

ø mm	L1 mm	L2 mm	ks/bal	Obj. č.	MOC s DPH
------	-------	-------	--------	---------	-----------

## Vrtáky do kovov z rýchloreznej ocele (HSS) \*\*\*



Tvrdený hrot HSS-R

Vrtáky s výbrusom vhodné pre železné a neželezné kovy, ktoré ponúkajú dobrú rýchlosť vrtania a predĺženú životnosť.

Dostupné v priemeroch 1,5 mm – 13 mm



1,50	40	18	10	D-06236	2,69 €
2,00	49	24	10	D-06258	3,59 €
2,25	53	27	10	D-06264	4,39 €
2,50	57	30	10	D-06270	4,09 €
2,75	61	33	10	D-06286	3,89 €
3,00	61	33	10	D-06292	5,69 €
4,00	75	43	10	D-06339	9,79 €
4,25	75	43	10	D-06345	9,19 €
4,50	80	47	10	D-06351	9,39 €
4,75	80	47	10	D-06367	8,89 €
5,00	86	52	10	D-06373	12,99 €
5,50	93	57	10	D-06395	11,99 €
6,00	93	57	10	D-06410	16,99 €
6,50	101	63	10	D-06432	16,99 €
7,00	109	69	10	D-06454	15,99 €
8,00	117	75	10	D-06498	36,99 €
8,50	117	75	5	D-06513	14,99 €
9,00	125	81	5	D-06535	20,99 €
10,00	133	87	5	D-06579	26,99 €
10,50	133	87	5	D-06591	28,99 €
11,00	142	94	5	D-06600	32,99 €
13,00	151	101	5	D-06644	46,99 €

**Sada vrtákov HSS 13 ks** **D-54075** **7,19 €** (MOC s DPH)

1,5/2/2,5/3/3,2/3,5/4/4,5  
4,8/5/5,5/6/6,5 mm

\*\*\*

**Sada vrtákov HSS 19 ks** **D-54081** **16,99 €** (MOC s DPH)

1/1,5/2/2,5/3/3,5/4/4,5/5/5,5/  
6/6,5/7/7,5/8/8,5/9/9,5/10 mm

\*\*\*

## Vrták na vrtanie otvorov pre nity \*\*\*

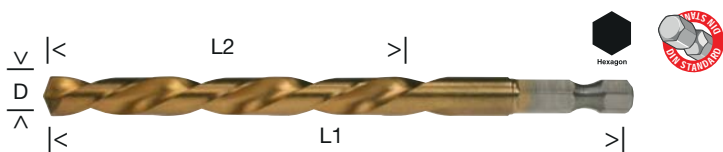

Vrtáky z úpravou Nitrid titánu pre predĺženú životnosť.

S 1/4" upínanie vhodné pre rýchloúpinacie systémy a šesťhranné upínanie. Priemery od 3 – 13mm. Sady sú s valcovitou stopkou.



3	80	47	1	D-14928	1,49 €
3,3	85	52	1	D-16081	1,69 €
4	95	57	1	D-14940	1,79 €
4,2	95	57	1	D-14956	1,79 €
5	105	65	1	D-14962	2,19 €
6	110	69	1	D-14978	2,79 €
8	115	75	1	D-15827	6,49 €
10	130	87	1	D-15833	7,89 €

**Sada vrtákov HSS – Tin 19 ks** **D-72229** **25,99 €** (MOC s DPH)

1,0; 1,5; 2,0; 2,5; 3,0; 3,5; 4,0; 4,5;  
5,0; 5,5; 6,0; 6,5; 7,0; 7,5; 8,0; 8,5;  
9,0; 9,5; 10

\*\*\*

**Sada vrtákov HSS – Tin 13 ks** **D-72855** **9,89 €** (MOC s DPH)

1,5 – 10 mm × 40 – 130 mm

\*\*\*

**Sada vrtákov do kovu HSS-Tin 6 ks** **D-72833** **7,19 €** (MOC s DPH)

Ø mm 2; 3; 4; 5; 6; 8

**Sada vrtákov HSS – Tin 10 ks** **D-72849** **12,99 €** (MOC s DPH)

1; 2; 3; 4; 5; 6; 7;  
8; 9; 10

# VRTANIE: VRTÁKY DO KOVOV Z RÝCHLOREZNEJ OCELE (HSS)

ø mm	L1 mm	L2 mm	ks/bal	Obj. č.	MOC s DPH
------	-------	-------	--------	---------	-----------

## Vrtáky do kovov HSS-Co 5 %

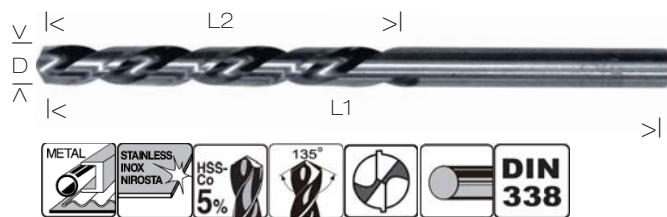

### Kobaltové valcovitá stopka

Vrtáky HSS podľa DIN338 s oceľou M35 s obsahom 5% a 8% kobaltu. Toto znamená, že vrták je silnejší a v porovnaní so štandardnými vydrží dlhšie. Uhol špičky 118 ° znižuje riziko pošmyknutia vrtáka určené pre vrtanie do kvalitných ocelí, ťahaných alebo s veľkým obsahom zliatin. Použitie na mäkkú oceľ, nehrdzavejúcu oceľ a ťažko obrábateľné materiály, zvarané švy a práce na karosérii.

2,00	49	24	1	D-17295	1,19 €
2,50	57	30	1	D-17304	0,99 €
3,00	61	33	1	D-17310	1,59 €
3,50	70	39	1	D-17332	1,39 €
4,00	75	43	1	D-17348	1,89 €
4,50	80	47	1	D-17354	2,39 €
5,00	86	52	1	D-17360	2,69 €
5,50	93	57	1	D-17376	2,29 €
6,00	93	57	1	D-17382	3,09 €
6,50	101	63	1	D-17398	3,39 €
8,00	117	75	1	D-17429	5,39 €
12,00	151	101	1	D-17500	15,99 €

ø mm	L1 mm	L2 mm	ks/bal	Obj. č.	MOC s DPH
------	-------	-------	--------	---------	-----------



1,00	34		10	P-61416-10	6,29 €
1,50	40	16	10	P-61438-10	6,59 €
1,60	43	18	10	P-76087-10	7,19 €
2,00	49	24	10	P-61450-10	7,19 €
2,30	53	27	10	P-76146-10	8,89 €
2,40	57	30	10	P-76152-10	8,89 €
2,50	57	30	10	P-61472-10	8,89 €
2,60	57	30	10	P-76168-10	9,99 €
2,80	61	33	10	P-76180-10	9,99 €
2,90	61	33	10	P-76196-10	9,99 €
3,00	61	33	10	P-61494-10	9,99 €
3,20	65	36	10	P-76211-10	11,99 €
3,25	65	36	10	P-61503-10	12,99 €
3,40	70	39	10	P-76233-10	12,99 €
3,50	70	39	10	P-61519-10	12,99 €
3,75	70	39	10	P-61525-10	14,99 €
3,90	75	43	10	P-76277-10	14,99 €
4,00	75	43	10	P-61531-10	14,99 €
4,10	75	43	10	P-76283-10	15,99 €
4,20	75	43	10	P-76299-10	15,99 €
4,25	75	43	10	P-61547-10	16,99 €
4,30	80	47	10	P-76308-10	16,99 €
4,50	80	47	10	P-61553-10	16,99 €
4,60	80	47	10	P-76320-10	18,99 €
4,80	86	52	10	P-76342-10	18,99 €
4,90	86	52	10	P-76358-10	19,99 €
5,00	86	52	10	P-61575-10	19,99 €
5,10	86	52	10	P-76364-10	22,99 €

ø mm	L1 mm	L2 mm	ks/bal	Obj. č.	MOC s DPH
------	-------	-------	--------	---------	-----------



5,20	86	52	10	P-76370-10	22,99 €
5,25	86	52	10	P-61581-10	22,99 €
5,50	93	57	10	P-61597-10	22,99 €
5,90	93	57	10	P-76439-10	26,99 €
6,00	93	57	10	P-61612-10	26,99 €
6,10	101	63	10	P-76445-10	32,99 €
6,20	101	63	10	P-76451-10	32,99 €
6,30	101	63	10	P-76467-10	32,99 €
6,40	101	63	10	P-76473-10	32,99 €
6,60	101	63	10	P-76489-10	39,99 €
6,70	101	63	10	P-76495-10	39,99 €
6,80	109	69	10	P-76504-10	39,99 €
7,00	109	69	10	P-61656-10	39,99 €
7,30	109	69	10	P-76548-10	43,99 €
7,50	109	69	10	P-61678-10	43,99 €
8,00	117	75	10	P-61690-10	53,99 €
8,10	117	75	5	P-76607-5	29,99 €
8,20	117	75	5	P-76613-5	29,99 €
8,50	117	75	5	P-61715-5	29,99 €
9,00	125	81	5	P-61721-5	34,99 €
10,00	133	87	5	P-61743-5	43,99 €
10,50	133	87	5	P-61759-5	48,99 €
11,00	142	94	5	P-61765-5	56,99 €
11,50	142	94	5	P-61771-5	61,99 €
12,00	151	101	5	P-61787-5	69,99 €
12,50	151	101	5	P-61793-5	75,99 €
13,00	151	101	5	P-61802-5	81,99 €



# VŔTANIE: VRTÁKY DO KOVOV Z RÝCHLOREZNEJ OCELE (HSS)

	ø mm	L1 mm	L2 mm	ks/bal	Obj. č.	MOC s DPH
--	------	-------	-------	--------	---------	-----------

## Vrtáky do kovov HSS-Co 5 %



DIN340, špička pod uhlom 130°



5,00	132	87	10	P-62826-10	42,99 €
13,00	205	155	5	P-62985-5	156,99 €

## Vrtáky do kovov HSS-Co 8 % s valcovitou stopkou



DIN338, špička pod uhlom 130°



2,00	49	24	10	P-61880-10	13,59 €
2,50	57	30	10	P-61905-10	15,39 €
3,00	61	33	10	P-61927-10	16,29 €
3,50	70	39	10	P-61949-10	18,69 €
4,00	75	43	10	P-61961-10	22,09 €
4,25	75	43	10	P-61977-10	24,49 €
4,50	80	47	10	P-61983-10	24,49 €
5,00	86	52	10	P-62000-10	29,39 €
6,00	93	57	10	P-62044-10	40,49 €
6,50	101	63	10	P-62066-10	48,19 €
7,50	109	69	10	P-62094-10	64,19 €
8,00	117	75	10	P-62103-10	76,09 €
10,00	133	89	5	P-62147-5	64,49 €

## Vrtáky do kovov HSS-TiN s valcovitou stopkou



DIN338, špička pod uhlom 130°



1,00	34		10	P-60981-10	4,89 €
1,50	40	16	10	P-61008-10	5,29 €
2,00	49	24	10	P-61020-10	5,89 €
2,50	57	30	10	P-61042-10	6,39 €
3,00	61	33	10	P-61064-10	8,39 €
3,25	65	36	10	P-61070-10	10,29 €
3,50	70	39	10	P-61086-10	10,29 €
4,00	75	43	10	P-61101-10	11,09 €
4,25	75	43	10	P-61117-10	13,99 €
4,50	80	47	10	P-61123-10	13,99 €
5,00	86	52	10	P-61145-10	15,99 €
5,50	93	57	10	P-61167-10	18,99 €
6,00	93	57	10	P-61189-10	21,99 €
6,50	101	63	10	P-61204-10	25,99 €
7,00	109	69	10	P-61226-10	29,99 €
7,50	109	69	10	P-61248-10	34,99 €
8,00	117	75	10	P-61260-10	39,99 €
8,50	117	75	5	P-61282-5	22,99 €
9,00	125	81	5	P-61298-5	25,99 €
10,00	133	87	5	P-61313-5	33,99 €
10,50	133	87	5	P-61329-5	37,99 €
12,00	151	101	5	P-61357-5	51,99 €
12,50	151	101	5	P-61367-5	55,99 €
13,00	151	101	5	P-61379-5	60,99 €

## VŔTANIE: VRTÁKY DO KOVOV Z RÝCHLOREZNEJ OCELE (HSS)

ø mm	L1 mm	L2 mm	ks/bal	Obj. č.	MOC s DPH
------	-------	-------	--------	---------	-----------

### Obojstranné vrtáky HSS-G



Vhodné na vytváranie otvorov pre nity a predvrtávanie závitov



2,00	38	7,5	10	B-26652	3,09 €
3,00	46	10,6	10	B-26668	4,59 €
3,10	49	11	10	B-26674	5,59 €
3,20	49	11	10	B-26680	6,29 €
3,30	49	11	10	B-26696	6,99 €
3,50	52	13	10	B-26705	6,59 €
3,80	55	14	10	B-26711	7,29 €
4,10	55	14	10	B-26733	7,89 €
4,20	55	14	10	B-26749	8,89 €
4,30	55	14	10	B-26755	8,89 €
4,80	62	17	10	B-26777	10,99 €
4,90	62	17	10	B-26783	10,99 €
5,00	62	17	10	B-26799	10,99 €
5,10	62	17	10	B-26808	13,99 €
5,2	62	17	10	B-26814	13,99 €



# VŔTANIE: VRTÁKY DO KOVOV Z RÝCHLOREZNEJ OCELE (HSS)

ø mm	L1 mm	L2 mm	ks/bal	Obj. č.	MOC s DPH	ø mm	L1 mm	L2 mm	ks/bal	Obj. č.	MOC s DPH
Vrtáky do kovov HSS-G s valcovitou stopkou 											
1,00	34	12	10	P-60115-10	2,59 €	5,25	86	52	10	P-60280-10	14,99 €
1,10	36	14	10	P-75328-10	2,69 €	5,30	86	52	10	P-75661-10	14,99 €
1,20	38	16	10	P-75334-10	2,69 €	5,50	93	57	10	P-60296-10	14,99 €
1,25	38	16	10	P-60121-10	2,69 €	5,60	93	57	10	P-75683-10	15,99 €
1,30	38	16	10	P-75340-10	2,69 €	5,80	93	57	10	P-75708-10	15,99 €
1,40	40	18	10	P-75356-10	2,69 €	6,00	93	57	10	P-60311-10	15,99 €
1,50	40	18	10	P-60137-10	2,69 €	6,10	101	63	10	P-75720-10	15,99 €
1,60	43	20	10	P-75362-10	3,29 €	6,20	101	63	10	P-75736-10	15,99 €
1,70	43	20	10	P-75378-10	3,29 €	6,25	101	63	10	P-60327-10	15,99 €
1,75	46	22	10	P-60143-10	3,29 €	6,30	101	63	10	P-75742-10	15,99 €
1,80	46	22	10	P-75384-10	3,29 €	6,40	101	63	10	P-75758-10	15,99 €
1,90	46	22	10	P-75390-10	3,29 €	6,50	101	63	10	P-60333-10	15,99 €
2,00	49	24	10	P-60159-10	3,29 €	6,70	101	63	10	P-75770-10	18,99 €
2,10	49	24	10	P-75409-10	4,19 €	6,80	109	69	10	P-75786-10	18,99 €
2,20	53	27	10	P-75415-10	4,19 €	7,00	109	69	10	P-60355-10	18,99 €
2,30	53	27	10	P-75421-10	4,19 €	7,20	109	69	10	P-75817-10	20,99 €
2,40	57	30	10	P-75437-10	4,19 €	7,50	109	69	10	P-60377-10	20,99 €
2,50	57	30	10	P-60171-10	4,19 €	7,70	117	75	10	P-75851-10	22,99 €
2,60	57	30	10	P-75443-10	5,09 €	7,80	117	75	10	P-75867-10	22,99 €
2,70	61	33	10	P-75459-10	5,09 €	7,90	117	75	10	P-75873-10	22,99 €
2,80	61	33	10	P-75465-10	5,09 €	8,00	117	75	10	P-60399-10	22,99 €
2,90	61	33	10	P-75471-10	5,59 €	8,10	117	75	5	P-75889-5	13,99 €
3,00	61	33	10	P-60193-10	5,59 €	8,20	117	75	5	P-75895-5	13,99 €
3,10	65	36	10	P-75487-10	6,49 €	8,30	117	75	5	P-75904-5	13,99 €
3,20	65	36	10	P-75493-10	6,49 €	8,40	117	75	5	P-75910-5	13,99 €
3,25	65	36	10	P-60202-10	7,19 €	8,50	117	75	5	P-60414-5	13,99 €
3,30	65	36	10	P-75502-10	7,19 €	8,60	125	81	5	P-75926-5	15,99 €
3,40	70	39	10	P-75518-10	7,19 €	9,00	125	81	5	P-60420-5	15,99 €
3,50	70	39	10	P-60218-10	7,19 €	9,50	125	81	5	P-60436-5	17,99 €
3,60	70	39	10	P-75524-10	8,29 €	9,70	133	87	5	P-76015-5	20,99 €
3,70	70	39	10	P-75530-10	8,29 €	9,80	133	87	5	P-76021-5	20,99 €
3,80	75	43	10	P-75546-10	8,29 €	9,90	133	87	5	P-76037-5	20,99 €
3,90	75	43	10	P-75552-10	8,29 €	10,00	133	87	5	P-60442-5	20,99 €
4,00	75	43	10	P-60230-10	8,29 €	10,50	133	87	5	P-60458-5	22,99 €
4,10	75	43	10	P-75568-10	8,99 €	11,00	142	94	5	P-60464-5	26,99 €
4,20	75	43	10	P-75574-10	8,99 €	11,50	142	94	5	P-60470-5	28,99 €
4,25	75	43	10	P-60246-10	10,19 €	12,00	151	101	5	P-60486-5	31,99 €
4,30	80	47	10	P-75580-10	10,19 €	12,50	151	101	5	P-60492-5	33,99 €
4,40	80	47	10	P-75596-10	10,19 €	13,00	151	101	5	P-60501-5	34,99 €
4,50	80	47	10	P-60252-10	10,19 €						
4,60	80	47	10	P-75605-10	11,99 €						
4,70	80	47	10	P-75611-10	11,99 €						
4,80	86	52	10	P-75627-10	11,99 €						
4,90	86	52	10	P-75633-10	12,99 €						
5,00	86	52	10	P-60274-10	12,99 €						
5,10	86	52	10	P-75649-10	14,99 €						
5,20	86	52	10	P-75655-10	14,99 €						

## VŘTANIE: VRTÁKY DO KOVOV Z RÝCHLOREZNEJ OCELE (HSS)

ø mm	L1 mm	L2 mm	ks/bal	Obj. č.	MOC s DPH	ø mm	L1 mm	L2 mm	ks/bal	Obj. č.	MOC s DPH
<b>Vrtáky do kovov HSS-G s valcovitou stopkou</b> 											
2,0	125		1	P-63024	4,09 €	5,50	205		1	P-63236	12,99 €
2,50	140		1	P-63052	4,59 €	6,00	205		1	P-63264	12,99 €
3,00	150		1	P-63080	4,69 €	6,00	260		1	P-63270	19,99 €
3,00	190		1	P-63096	9,29 €	6,00	330		1	P-63286	25,99 €
3,50	165		1	P-63111	7,09 €	7,00	225		1	P-63323	15,99 €
3,50	265		1	P-63133	14,99 €	8,00	240		1	P-63389	17,99 €
4,00	175		1	P-63149	7,69 €	8,00	305		1	P-63395	27,99 €
4,00	220		1	P-63155	12,99 €	8,00	390		1	P-63404	41,99 €
4,50	185		1	P-63177	7,89 €	10,00	265		1	P-63507	27,99 €
5,00	195		1	P-63208	8,69 €	10,00	340		1	P-63513	38,99 €
5,00	245		1	P-63214	15,99 €	10,00	430		1	P-63529	53,99 €
5,00	315		1	P-63220	24,99 €	13,00	295		1	P-63688	40,99 €

<b>Vrtáky do kovov HSS-GM2 s valcovitou stopkou</b> 											
špička pod uhlom 130°											
1,00	34	12	10	P-60545-10	4,79 €	6,00	93	57	10	P-60741-10	21,99 €
1,50	40	18	10	P-60567-10	5,19 €	6,00	139	91	10	P-62599-10	41,99 €
2,00	49	24	10	P-60589-10	5,59 €	6,50	101	63	10	P-60763-10	25,99 €
2,00	85	52	10	P-62511-10	10,59 €	6,50	148	99	10	P-62608-10	49,99 €
2,25	53	26	10	P-60595-10	6,09 €	7,00	109	69	10	P-60785-10	29,99 €
2,50	57	30	10	P-60604-10	6,09 €	7,00	156	105	10	P-62614-10	56,99 €
2,50	95	59	10	P-62527-10	11,19 €	7,50	109	69	10	P-60800-10	33,99 €
3,00	61	33	10	P-60626-10	7,69 €	8,00	117	75	10	P-60822-10	38,99 €
3,00	100	63	10	P-62533-10	14,99 €	8,00	165	115	10	P-62636-10	71,99 €
3,50	70	39	10	P-60648-10	9,49 €	8,50	117	75	5	P-60844-5	22,99 €
3,50	112	71	10	P-62549-10	17,99 €	8,50	165	115	5	P-62642-5	40,99 €
4,00	119	77	10	P-62555-10	21,99 €	9,00	125	81	5	P-60850-5	25,99 €
4,50	80	47	10	P-60682-10	13,99 €	9,50	125	81	5	P-60866-5	28,99 €
4,50	126	81	10	P-62561-10	24,99 €	10,00	133	87	5	P-60872-5	33,99 €
5,00	86	52	10	P-60707-10	16,99 €	10,00	184	134	5	P-62670-5	60,99 €
5,00	132	87	10	P-62577-10	30,99 €	10,50	133	87	5	P-60888-5	36,99 €
5,50	93	57	10	P-60729-10	18,99 €	11,00	142	94	5	P-60894-5	41,99 €
						12,00	151	101	5	P-60919-5	51,99 €
						12,50	151	101	5	P-60925-5	55,99 €
						13,00	151	101	5	P-60931-5	59,99 €

# VŔTANIE: VRTÁKY DO KOVOV Z RÝCHLOREZNEJ OCELE (HSS)

ø mm	L1 mm	L2 mm	ks/bal	Obj. č.	MOC s DPH
------	-------	-------	--------	---------	-----------

## Vrtáky do kovov HSS-GS s valcovitou stopkou špička pod uhlom 135° \*\*\*



1	34		10	D-77992	2,49 €
1,5	40		10	D-78003	2,69 €
2	49		10	D-78019	2,99 €
2,5	57		10	D-78025	3,89 €
3	61		10	D-78031	4,59 €
3,2	65		10	D-78047	5,79 €
3,5	70		10	D-78053	5,99 €
4	75		10	D-78069	6,99 €
4,2	75		10	D-78075	8,29 €
4,5	80		10	D-78081	8,49 €
5	86		10	D-78097	9,99 €
5,5	93		10	D-78106	11,99 €
6	93		10	D-78112	13,99 €
6,5	101		10	D-78128	15,99 €
7	109		10	D-78134	18,99 €
7,5	109		10	D-78140	21,99 €
8	117		10	D-78156	24,99 €
8,5	117		5	D-78162	14,99 €
9	125		5	D-78178	16,99 €
9,5	125		5	D-78184	17,99 €
10	133		5	D-78190	20,99 €
10,5	133		5	D-78209	22,99 €
11	142		5	D-78215	25,99 €
11,5	142		5	D-78221	27,99 €
12	151		5	D-78237	30,99 €
12,5	151		5	D-78243	32,99 €
13	151		5	D-78259	35,99 €

Sada vrtákov HSS-GS 6 ks	D-78346	9,09 € (MOC s DPH)
2; 3; 4; 5; 6; 8 PVC obal		
***		

Akumulátory  
 Odkládacie systémy  
 Vŕtanie  
 Skrutkovanie  
 Brúsky  
 Pilenie  
 Frézovanie  
 Brúsenie  
 Klince / spony  
 Špeciálne stroje  
 Vysávanie  
 Fény/lampy  
 Záhrada  
 Ručné náradie  
 Ostatné

# VRTANIE: VRTÁKY DO KOVOV Z RÝCHLOREZNEJ OCELE SADY

## Sady vrtákov do kovov z rýchloreznej ocele (HSS-G)

**Sada vrtákov HSS – G 19 ks** **P-73673** **37,99 €** (MOC s DPH)

1; 1,5; 2; 2,5; 3; 3,5; 4; 4,5; 5; 5,5;  
6; 6,5; 7; 7,5; 8,5; 9; 9,5; 10;  
PVC obal



\*\*\*\*\*

**Sada vrtákov HSS – G 19 ks** **P-60517** **31,99 €** (MOC s DPH)

1; 1,5; 2; 2,5; 3; 3,5; 4; 4,5; 5; 5,5;  
6; 6,5; 7; 7,5; 8,5; 9; 9,5; 10;  
Kovový obal



\*\*\*\*\*

**Sada vrtákov HSS – G 25 ks** **P-73689** **73,99 €** (MOC s DPH)

1; 1,5; 2; 2,5; 3; 3,5; 4; 4,5; 5; 5,5;  
6; 6,5; 7; 7,5; 8,5; 9; 9,5; 10; 10,5;  
11; 11,5; 12; 12,5; 13;  
PVC obal



\*\*\*\*\*

**Sada vrtákov HSS – G 25 ks** **P-60523** **65,99 €** (MOC s DPH)

1; 1,5; 2; 2,5; 3; 3,5; 4; 4,5; 5; 5,5;  
6; 6,5; 7; 7,5; 8,5; 9; 9,5; 10; 10,5;  
11; 11,5; 12; 12,5; 13;  
Kovový obal



\*\*\*\*\*

**Sada vrtákov s 1/4" upínaním 5 ks** **D-20769** **15,99 €** (MOC s DPH)

5; 6; do dreva  
5; 6; 8; HSS-Tin do kovu



\*\*\*\*\*

**Sada vrtákov s 1/4" upínaním 5 ks** **D-23759** **13,99 €** (MOC s DPH)

5; 6; do dreva  
5; 6; ; HSS-Tin do kovu  
6; HN CT do tehly a muriva



\*\*\*\*\*

**Sada vrtákov do muriva/ kovu/ muriva** **P-23818** **25,99 €** (MOC s DPH)

HSS 3; 4; 5; 6; 8; 10  
murivo 3; 4; 5; 6; 8; 10  
drevo 3; 4; 5; 6; 8; 10  
18 ks v PVC obal



\*\*\*\*\*

**Sada vrtákov HSS – Tin 19 ks** **D-67527** **23,99 €** (MOC s DPH)

1,5 x 2; 2 x 2; 2,5 x 2; 3 x 2; 3,2; 3,5  
4; 4,5; 5; 5,5; 6; 6,5; 7; 8; 10



\*\*\*\*\*

**Sada vrtákov HSS-CO 5 % 10 ks** **D-57174** **32,99 €** (MOC s DPH)

1; 2; 3; 4; 5; 6; 7; 8; 9; 10;



# VRTANIE: HSS-CO VRTÁKY DO KOVU Z RÝCHLOREZNEJ OCELE S VALCOVITOU STOPKOU

Dĺžka	Priemer mm	Upínanie	Použitie	Počet bríťov	Obj. č.	MOC s DPH
-------	------------	----------	----------	--------------	---------	-----------

## Záhlbníkový trojbríťový vrták do kovu HSS 90°



**DIN 338**

Valcovitá stopka. Na hlboké zapustenie sa používa záhlbník s tromi frézami a veľkými drážkami. Je to najbežnejší typ zahĺbenia.



	4,3	valcovitá stopka	M2	3	P-73514	4,59 €
	5,3	valcovitá stopka	M2,5	3	P-73520	4,59 €
	6,3	valcovitá stopka	M3	3	P-73536	5,19 €
	8,3	valcovitá stopka	M4	3	P-73542	6,19 €
	9,4	valcovitá stopka	M4,5	3	P-73558	7,19 €
	10,4	valcovitá stopka	M5	3	P-73564	7,59 €
	12,4	valcovitá stopka	M6	3	P-73570	9,39 €
	16,5	valcovitá stopka	M8	3	P-73586	13,99 €

## Záhlbníkový trojbríťový vrták do kovu HSS-CO 90°



**DIN 338**

Záhlby so šikmými otvormi majú kužeľovú hlavu so šikmým otvorom. Reznú hranu tvorí šikmý otvor na reznej hlave. Vďaka špeciálnej geometrii reznej hrany môže pilina unikáť kontinuálnym tokom, čo umožňuje stabilnejšie, hladšie a zaoblené zahĺbenie, najmä u tenkých plechov.



	6,3	valcovitá stopka	M3	3	P-73601	7,89 €
	8,3	valcovitá stopka	M4	3	P-73617	9,99 €
	10,4	valcovitá stopka	M5	3	P-73623	11,99 €
	12,4	valcovitá stopka	M6	3	P-73639	15,99 €
	16,5	valcovitá stopka	M8	3	P-73645	22,99 €

## Záhlbníkový vrták do kovu HSS 90°



**DIN 338**

Záhlbník so šikmými otvormi ma kužeľovú hlavu so šikmým otvorom. Reznú hranu tvorí šikmý otvor na reznej hlave. Vďaka špeciálnej geometrii reznej hrany môže pilina unikáť kontinuálnym tokom, čo umožňuje stabilnejšie, hladšie a zaoblené zahĺbenie, najmä u tenkých plechov.



	5 – 10	valcovitá stopka	90°	1	P-73651	9,39 €
	15 – 20	valcovitá stopka	90°	1	P-73667	12,99 €

## Sada záhlbníkov 6 ks

P-73592

58,99 € (MOC s DPH)

Dĺžka: 45 mm – 63 mm  
 Priemer: 6,3 mm, 8,3 mm,  
 10,4 mm, 12,4 mm, 16,5 mm,  
 20,5 mm  
 Valcovitá stopka 5 – 10 mm  
 3 – bríť  
 Hlboké zahĺbenie pre otvory:  
 M3, M4, M5, M6, M8, M10

**DIN 338**



# VŘTANIE: STUPŇOVITÉ VRTÁKY

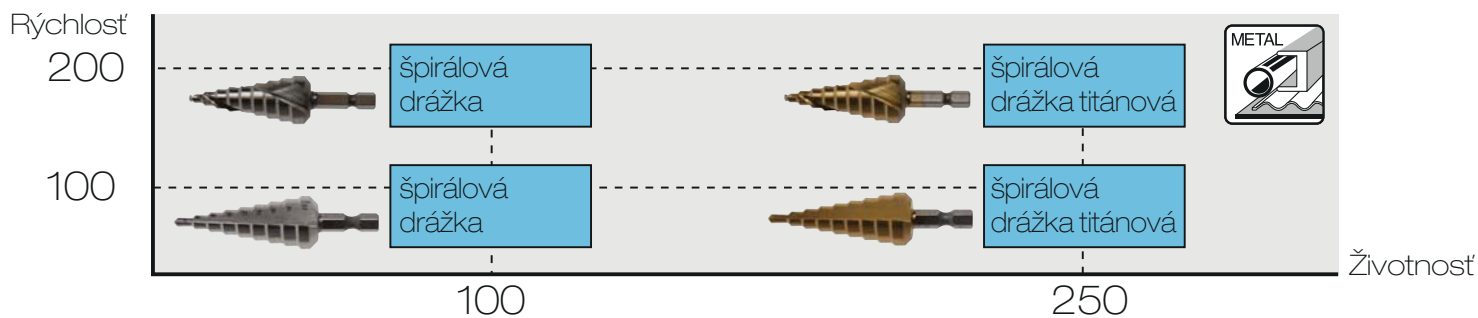

Drážka	Upínanie	Pre otvory	Obj. č.	MOC s DPH
--------	----------	------------	---------	-----------

## Stupňovité vrtáky HSS-G so špirálovou drážkou



špirálová / 9	valcovitá stopka	4 – 12	P-69892	20,99 €
špirálová / 9	valcovitá stopka	4 – 20	P-69901	34,99 €
špirálová / 14	valcovitá stopka	4 – 30	P-69917	74,99 €
špirálová / 13	valcovitá stopka	6 – 30	P-69923	73,99 €
špirálová / 12	valcovitá stopka	6 – 38	P-69939	94,99 €

## Stupňovité vrtáky HSS-Co + TiN so špirálovou drážkou



špirálová / 9	valcovitá stopka	4 – 12	P-69967	27,99 €
špirálová / 9	valcovitá stopka	4 – 20	P-69973	47,99 €
špirálová / 13	valcovitá stopka	6 – 30	P-69995	103,99 €
špirálová / 12	valcovitá stopka	6 – 38	P-70007	140,99 €

### Sada stupňovitých vrtákov 3 ks HSS-G

P-69951 127,99 € (MOC s DPH)

drážka špirálová / 9 pre otvory 4 – 12  
 drážka špirálová / 9 4 – 20  
 drážka špirálová / 14 4 – 30



### Sada stupňovitých vrtákov 3 ks HSS-Co + TiN

P-70029 180,99 € (MOC s DPH)

drážka špirálová / 9 pre otvory 4 – 12  
 drážka špirálová / 9 4 – 20  
 drážka špirálová / 14 4 – 30





## VŔTANIE: SKLO

ø mm	L1 mm	L2 mm	ks/bal	Obj. č.	MOC s DPH
------	-------	-------	--------	---------	-----------

### Vrtáky do skla s 1/4" šesťhrannou stopkou



4	65		1	D-15942	3,09 €
5	65		1	D-15958	3,19 €
6	65		1	D-15964	3,49 €
8	70		1	D-15970	3,59 €
10	80		1	D-15986	4,49 €

### Vrtáky do skla s dvoj rezným hrotom



Ø do 6 mm valcovitá stopka,  
Ø od 7 mm trojhranná stopka

6	58	-	1	D-78433	1,99 €
8	58	-	1	D-78455	2,59 €
10	96	-	1	D-78461	3,19 €
12	96	-	1	D-78477	4,09 €

### Vrtáky do skla s valcovou stopkou



3	65		1	P-60012	3,09 €
4	65		1	P-60028	3,19 €
5	65		1	P-60034	3,39 €
6	65		1	P-60040	3,59 €
7	70		1	P-60056	3,89 €
8	70		1	P-60062	4,09 €
9	70		1	P-60078	4,59 €
10	98		1	P-60084	4,89 €
12	98		1	P-60090	5,89 €
13	98		1	P-60109	6,79 €

## VŔTANIE: DO MURIVA A KAMEŇA

ø mm	L1 mm	L2 mm	ks/bal	Obj. č.	MOC s DPH
------	-------	-------	--------	---------	-----------

### Vrtáky do muriva a kameňa s valcovitou stopkou



4	70	40	1	D-05234	1,19 €
5	85	50	1	D-05240	1,29 €
6	100	60	1	D-05256	1,29 €
6	150	90	1	D-05262	1,19 €
8	110	90	1	D-05290	1,39 €
8	150	90	1	D-05309	1,29 €
10	150	90	1	D-05321	1,69 €
12	150	90	1	D-05343	1,99 €
12	600	550	1	D-17728	5,49 €
13	150	90	1	D-05359	1,99 €
14	150	90	1	D-05365	2,39 €
15	150	90	1	D-05371	3,29 €
16	600	550	1	D-17734	7,59 €

### Sada vrtákov do muriva a kameňa

D-72877

6,19 €

(MOC s DPH)

valcovitá stopka  
ø mm 4, 5, 6, 8, 10



# VŔTANIE: DREVO

## Ploché frérovacie vrtáky do dreva



D priemer mm  
L1 celková dĺžka  
L2 pracovná dĺžka  
Vhodné pre mäkké aj tvrdé drevo so šesťhrannou stopkou



ø mm	L1 mm	L2 mm	ks/bal	Obj. č.	MOC s DPH
10	150	120	1	D-07696	1,49 €
12	150	120	1	D-07705	1,89 €
14	150	120	1	D-07711	2,09 €
16	150	120	1	D-07733	2,09 €
20	150	120	1	D-07755	2,39 €
25	150	120	1	D-07783	2,69 €
26	160	130	1	D-07799	2,99 €
30	160	130	1	D-07814	3,69 €
32	160	130	1	D-07820	2,89 €
34	160	130	1	D-07836	3,09 €
35	160	130	1	D-07842	3,09 €
36	160	130	1	D-07858	4,59 €

## Ploché frérovacie vrtáky do dreva

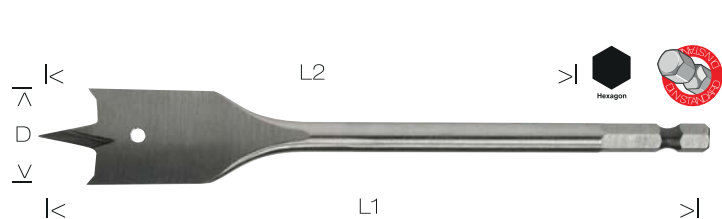

D priemer mm  
L1 celková dĺžka  
L2 pracovná dĺžka  
Ideálne pre väčšinu druhov dreva, tvrdé alebo mäkké, šesťhranná stopka



štandardná dĺžka					
ø mm	L1 mm	L2 mm	ks/bal	Obj. č.	MOC s DPH
6	150	120	1	P-58643	1,39 €
8	150	120	1	P-58659	1,59 €
10	150	120	1	P-58665	1,59 €
12	150	120	1	P-58671	1,69 €
14	150	120	1	P-58687	1,69 €
15	150	120	1	P-58693	1,69 €
16	150	120	1	P-58702	1,79 €
18	150	120	1	P-58713	1,89 €
20	150	120	1	P-58724	1,99 €
22	150	120	1	P-58730	2,19 €
24	150	120	1	P-58746	2,19 €
25	150	120	1	P-58752	2,59 €
26	160	130	1	P-58768	2,69 €
28	160	130	1	P-58774	2,89 €
30	160	130	1	P-58780	3,09 €
32	160	130	1	P-58796	3,39 €
34	160	130	1	P-58805	3,79 €
35	160	130	1	P-58811	3,79 €
36	160	130	1	P-58827	3,99 €

### Predĺženie

D-77213

cena na vyžiadanie (MOC s DPH)

predĺženie pre vrtáky so šesťhranným upnutím celková dĺžka 300 mm upínanie 1/4"



### Sada vrtákov

E-08698

25,99 € (MOC s DPH)

12, 14, 16, 18, 20, 22, 25, 32 × 150 mm



# VŘTANIE: DREVO

ø mm	L1 mm	L2 mm	ks/bal	Obj. č.	MOC s DPH
------	-------	-------	--------	---------	-----------

## Vrták špirálový do dreva s dvomi ostriami a centrovacím hrotom; valcovitá stopka



D priemer mm  
L1 celková dĺžka  
L2 pracovná dĺžka



štandardná dĺžka					
3	60	30	1	D-07026	0,79 €
4	75	43	1	D-07032	0,79 €
5	85	50	1	D-07048	0,89 €
6	95	58	1	D-07054	0,99 €
8	115	73	1	D-07076	1,29 €
9	125	80	1	D-07082	1,39 €
12	155	100	1	D-07107	2,19 €
16	180	130	1	D-07129	3,59 €
18	200	140	1	D-07135	5,69 €
20	200	140	1	D-07141	6,19 €
predĺžené					
6	315	150	1	D-07157	3,69 €
8	315	150	1	D-07163	4,29 €
10	315	150	1	D-07179	4,69 €
12	315	150	1	D-07185	6,39 €
14	315	150	1	D-07191	7,49 €
16	315	150	1	D-07200	9,79 €
18	335	150	1	D-07216	11,99 €
20	335	150	1	D-07222	14,99 €

## Skrutkovicové vrtáky do dreva s valcovitou stopkou



Vhodné na vrtanie otvorov s malým alebo stredným priemerom. Schopný vrtat aj mäkké plasty.



6	315		1	P-57679	2,49 €
8	315		1	P-57685	3,09 €
10	315		1	P-57691	3,89 €
12	315		1	P-57700	5,09 €
14	315		1	P-57716	5,99 €
16	315		1	P-57722	7,69 €
8	450		1	P-57750	5,09 €
16	450		1	P-57794	11,29 €
18	450		1	P-57803	14,99 €
20	450		1	P-57819	17,99 €

## Špirálové vrtáky do dreva podľa DIN338



3	60		1	P-57473	0,49 €
4	75		1	P-57489	0,59 €
5	85		1	P-57495	0,69 €
6	95		1	P-57504	0,69 €
7	110		1	P-57510	0,79 €
8	115		1	P-57526	0,99 €
9	125		1	P-57532	1,09 €
10	135		1	P-57548	1,29 €
12	155		1	P-57554	1,89 €
14	170		1	P-57560	2,69 €
16	180		1	P-57576	3,69 €
18	200		1	P-57582	5,89 €
20	200		1	P-57598	6,79 €
22	205		1	P-57607	9,49 €
24	215		1	P-57613	11,99 €
26	215		1	P-57629	14,99 €
28	220		1	P-57635	17,99 €
30	220		1	P-57641	19,99 €

## Špirálové vrtáky do dreva s valcovitou stopkou



8	600		1	P-57940	9,49 €
10	600		1	P-57956	10,29 €
12	600		1	P-57962	12,99 €
16	600		1	P-57984	16,99 €
30	600		1	P-58051	45,99 €

ø mm	L1 mm	L2 mm	ks/bal	Obj. č.	MOC s DPH
------	-------	-------	--------	---------	-----------

**Vrtáky do dreva so šesťhrannou stopkou**

4	200		1	P-58067	4,49 €
5	200		1	P-58073	4,59 €
6	200		1	P-58089	4,69 €
8	200		1	P-58095	5,19 €
8	300		1	P-58213	7,19 €
8	450		1	P-58350	7,99 €
8	600		1	P-58497	10,69 €
10	200		1	P-58104	6,09 €
10	300		1	P-58229	7,79 €
10	450		1	P-58366	9,59 €
10	600		1	P-58506	11,29 €
12	200		1	P-58110	7,19 €
12	300		1	P-58235	9,19 €
12	450		1	P-58372	11,49 €
12	600		1	P-58512	13,99 €
14	450		1	P-58388	13,99 €
14	600		1	P-58528	16,99 €
15	300		1	P-58257	12,99 €
16	200		1	P-58132	8,79 €
16	300		1	P-58263	13,99 €
16	450		1	P-58403	16,99 €
16	600		1	P-58534	18,99 €
18	200		1	P-58148	9,99 €
18	300		1	P-58279	15,99 €
18	450		1	P-58419	18,99 €
18	600		1	P-58540	22,99 €
20	200		1	P-58154	11,49 €
20	300		1	P-58285	17,99 €
20	450		1	P-58425	20,99 €
20	600		1	P-58556	25,99 €
22	200		1	P-58160	12,99 €
22	300		1	P-58291	18,99 €
22	450		1	P-58431	24,99 €
22	600		1	P-58562	27,99 €
24	200		1	P-58176	14,99 €
24	300		1	P-58300	20,99 €
24	450		1	P-58447	26,99 €
24	600		1	P-58578	30,99 €
25	300		1	P-58316	22,99 €
25	450		1	P-58453	29,99 €
26	300		1	P-58322	24,99 €
26	600		1	P-58584	37,99 €
28	300		1	P-58338	27,99 €
30	200		1	P-58207	19,99 €
30	300		1	P-58344	29,99 €
30	450		1	P-58481	40,99 €
30	600		1	P-58609	46,99 €
32	600		1	P-58615	50,99 €
34	600		1	P-58621	62,99 €
36	600		1	P-58637	69,99 €

## Sady vrtákov do dreva

<b>Sada vrtákov do dreva 7 ks</b> 1/4" upínanie, 7 ks, ø mm 2, 3, 3, 4, 5, 6, 8 ***	<b>D-62371</b> <b>7,39 €</b> (MOC s DPH)		<b>Vrták do dreva 1/4" upínanie</b> ø 6 x 200 mm ***	<b>D-15992</b> <b>4,09 €</b> (MOC s DPH)	
<b>Sada vrtákov do dreva 5 ks</b> valcovitá stopka ø mm 4, 5, 6, 8, 10 ****	<b>P-57657</b> <b>3,99 €</b> (MOC s DPH)		<b>Vrták do dreva 1/4" upínanie</b> ø 8 x 200 mm ***	<b>D-16003</b> <b>4,39 €</b> (MOC s DPH)	
<b>Sada vrtákov do dreva 5 ks</b> valcovitá stopka ø mm 4, 5, 6, 8, 10 ***	<b>D-72861</b> <b>8,29 €</b> (MOC s DPH)		<b>Sada vrtákov do dreva 7 ks</b> valcovitá stopka ø mm 3, 4, 5, 6, 7, 8, 10 ****	<b>P-57663</b> <b>6,19 €</b> (MOC s DPH)	

ø mm	L1 mm	L2 mm	ks/bal	Obj. č.	MOC s DPH
------	-------	-------	--------	---------	-----------

## Vrtáky na pánty



Forstnerové vrtáky s vystred'ovacou špičkou s 2 ostriami



ø mm	L1 mm	L2 mm	ks/bal	Obj. č.	MOC s DPH
8	90		1	P-58833	3,59 €
10	90		1	P-58849	3,79 €
12	90		1	P-58855	4,19 €
14	90		1	P-58861	4,69 €
15	90		1	P-58877	4,99 €
16	90		1	P-58883	5,19 €
18	90		1	P-58899	5,49 €
20	90		1	P-58908	5,69 €
22	90		1	P-58914	5,89 €
24	90		1	P-58920	6,29 €
25	90		1	P-58936	6,59 €
26	90		1	P-58942	7,29 €
28	90		1	P-58958	7,79 €
30	90		1	P-58964	8,09 €
32	90		1	P-58970	8,59 €
34	90		1	P-58986	9,19 €
35	90		1	P-58992	9,49 €
36	90		1	P-59003	9,69 €
38	90		1	P-59019	10,09 €
40	90		1	P-59025	11,19 €
42	90		1	P-59031	13,99 €
45	90		1	P-59047	13,99 €
48	90		1	P-58053	17,99 €
50	90		1	P-58069	17,99 €

## Vrtáky na pánty so šesťhrannou stopkou



ø mm	L1 mm	L2 mm	ks/bal	Obj. č.	MOC s DPH
32	127		1	D-29963	16,99 €
57	127		1	D-30025	33,99 €
65	127		1	D-30031	34,99 €
92	127		1	D-56518	65,99 €

ø mm	L1 mm	L2 mm	ks/bal	Obj. č.	MOC s DPH
------	-------	-------	--------	---------	-----------

**Skrutkové vrtáky do dreva s valcovitou stopkou**

6	200	130	1	D-07238	2,69 €
8	200	130	1	D-07244	3,29 €
10	200	130	1	D-07250	3,89 €
12	200	130	1	D-07266	4,29 €
14	200	130	1	D-07272	4,59 €
16	200	130	1	D-07288	5,09 €
18	200	130	1	D-07294	5,09 €
20	200	130	1	D-07303	6,09 €
22	200	130	1	D-07319	7,49 €
24	200	130	1	D-07325	9,39 €
6	250	180	1	D-07331	2,89 €
8	250	180	1	D-07347	3,49 €
10	250	180	1	D-07353	4,09 €
12	250	180	1	D-07369	4,29 €
14	250	180	1	D-07375	5,29 €
16	250	180	1	D-07381	5,79 €
18	250	180	1	D-07397	6,69 €
20	250	180	1	D-07406	7,19 €
22	250	180	1	D-07412	8,19 €
24	250	180	1	D-07428	8,79 €
8	400	230	1	D-07434	6,39 €
10	400	230	1	D-07440	6,79 €
12	400	230	1	D-07456	7,79 €
14	400	230	1	D-07462	8,49 €
16	400	230	1	D-07478	9,89 €
18	400	230	1	D-07484	12,99 €
20	400	230	1	D-07490	12,99 €
22	400	230	1	D-07509	14,99 €
24	400	230	1	D-07515	18,99 €
26	400	230	1	D-07521	19,99 €
28	400	230	1	D-07537	23,99 €
30	400	230	1	D-07543	25,99 €
8	450	370	1	D-07559	8,39 €
10	450	370	1	D-07565	7,89 €
12	450	370	1	D-07571	9,29 €
14	450	370	1	D-07587	9,99 €
16	450	370	1	D-07593	12,99 €
18	450	370	1	D-07602	14,99 €
20	450	370	1	D-07618	15,99 €
22	450	370	1	D-07624	17,99 €
24	450	370	1	D-07630	22,99 €
26	450	370	1	D-07646	22,99 €
28	450	370	1	D-07652	27,99 €
30	450	370	1	D-07668	30,99 €

# VŘTANIE: DREVO

ø mm	L1 mm	L2 mm	ks/bal	Obj. č.	MOC s DPH
------	-------	-------	--------	---------	-----------

## Špirálový vrták do dreva s valcovitou stopkou



8	600		1	P-57940	9,49 €
10	600		1	P-57956	10,29 €
12	600		1	P-57962	12,99 €
16	600		1	P-57984	16,99 €
30	600		1	P-58051	45,99 €

## 3D skrutkovité vrtáky do dreva s valcovitou stopkou

























8	400	325	1	E-07761	30,99 €
18	500	425	1	E-07967	49,99 €
22	400	325	1	E-07886	65,99 €



Akumulátory  
Odkládacie systémy  
Vŕtanie  
Skrutkovanie  
Brúsky  
Pílenie  
Frézovanie  
Brúsenie  
Klince / spony  
Špeciálne stroje  
Vysávanie  
Fény/lampy  
Záhrada  
Ručné náradie  
Ostatné

# Tabulka použitia

AA : Odporúčené A : Akceptovateľné

Použitie		železo	nerez	Aluminum	neželezné kovy	drevo	MDF	sádrokartón	PVC	sklo-laminát	mäkké obklady	tehla	vápenec	mramor
														
BiM	<i>Ezychange</i> Bi-Metal HSS 8%Co 	AA	A	AA	AA	AA			AA					
	BiM 	AA		A	A	AA			AA					
	BiM pre plechy 	AA	AA	A	A									
Karbíd volfrámu	<i>Ezychange</i> TCT 	AA	AA	AA	AA	AA			AA		A	A	A	
	Viacúčelový TCT 					AA	AA	AA	AA	AA	A		A	
	TCT 	AA	AA	A	A				AA	AA				
	TC zrnitý 										AA	AA		
Diamantové	Vákuovo spájkovaný diamant 										AA	AA	AA	AA
	Diamond wet holesaw 										AA			AA
Uhlíková ocel'	Uhlíková ocel' 					A		A	A					



# VŔTANIE: VYKRUŽOVACIE KORUNKY

ø mm	L1	Adaptér	ks/bal	Obj. č.	MOC s DPH
------	----	---------	--------	---------	-----------

## BiM vykružovacie korunky

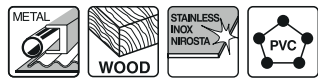

BiM vykružovacie korunky  
HSS bimetal  
Na vŕtanie do ocele, farebných kovov, plastov,  
dreva a sadrokartónu.

16	38	D-17170 / D-17603	1	D-16994	4,19 €
19	38	D-17170 / D-17603	1	D-17005	4,89 €
20	38	D-17170 / D-17603	1	D-17251	4,19 €
22	38	D-17170 / D-17603	1	D-17011	4,89 €
24	38	D-17170 / D-17603	1	D-17027	4,99 €
25	38	D-17170 / D-17603	1	D-17033	4,79 €
29	38	D-17170 / D-17603	1	D-17267	5,89 €
32	38	D-17186 / D-17619	1	D-17049	6,09 €
35	38	D-17186 / D-17619	1	D-17055	6,09 €
38	38	D-17186 / D-17619	1	D-17061	7,09 €
40	38	D-17186 / D-17619	1	D-17273	6,99 €
44	38	D-17186 / D-17619	1	D-17077	8,29 €
51	38	D-17186 / D-17619	1	D-17083	8,49 €
54	38	D-17186 / D-17619	1	D-24876	8,69 €
57	38	D-17186 / D-17619	1	D-17099	10,19 €
60	38	D-17186 / D-17619	1	D-25688	9,29 €
65	38	D-17186 / D-17619	1	D-24882	10,09 €
68	38	D-17186 / D-17619	1	D-17108	10,99 €
70	38	D-17186 / D-17619	1	D-25694	10,99 €
76	38	D-17186 / D-17619	1	D-17114	12,99 €
80	38	D-17186	1	D-33869	12,99 €
83	38	D-17186	1	D-17120	13,99 €
92	38	D-17186	1	D-17136	14,99 €
105	38	D-17186	1	D-17142	15,99 €
127	38	D-17186	1	D-17158	20,99 €
152	38	D-17186	1	D-17164	22,99 €



ø mm	ø mm	Adaptér/ upínanie	ks/bal	Obj. č.	MOC s DPH
16 - 29		Hex	1	D-17170	4,69 €
30 - 152		Hex	1	D-17186	8,29 €
14 - 29		SDS-PLUS	1	D-17603	5,89 €
30 - 76		SDS-PLUS	1	D-17619	11,99 €
6	75	centrovací vŕták	1	D-17192	3,49 €

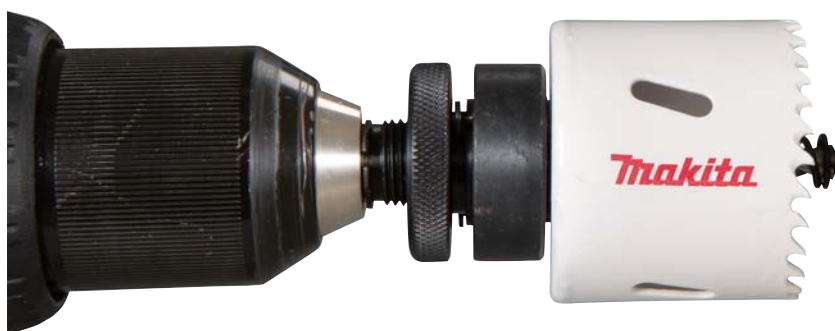

Akumulátory  
Okladacie systémy  
Vŕtanie  
Skrutkovanie  
Brúsky  
Pílenie  
Frézovanie  
Brúsenie  
Špeciálne stroje  
Klince / spony  
Vysávanie  
Fény/lampy  
Záhrada  
Ručné náradie  
Ostatné

# VŔTANIE: VYKRUŽOVACIE KORUNKY

## Vykružovacie korunky sady

**Sada vykružovacích korúnok vodárenská** D-47117 57,99 € (MOC s DPH)

ø 19, 22, 29, 38, 44, 57mm  
2x adaptér



\*\*\*\*\*

**Sada vykružovacích korúnok vodárenská** D-63965 52,99 € (MOC s DPH)

ø 19, 22, 29, 38, 44, 57mm  
2x adaptér



\*\*\*\*\*

**Sada vykružovacích korúnok elektrikárska** D-47139 57,99 € (MOC s DPH)

ø 20, 25, 32, 40, 51, 65mm  
2x adaptér



\*\*\*\*\*

**Sada vykružovacích korúnok elektrikárska** D-47123 53,99 € (MOC s DPH)

ø 16, 20, 25, 32, 40, 51mm  
2x adaptér



\*\*\*\*\*

**Sada Bi – metalových vykružovacích korúnok** D-33641 23,99 € (MOC s DPH)

ø 22, 25, 29, 32 mm  
adaptér



\*\*\*\*\*

**Sada Bi – metalových vykružovacích korúnok** D-33657 37,99 € (MOC s DPH)

ø 22, 29, 32, 51 mm  
adaptér



\*\*\*\*\*

**EzyChange sada vykružovacích korúnok** E-12304 158,99 € (MOC s DPH)

vodárenská  
ø 19, 22, 29, 38, 44, 57 mm,  
adaptér, strediaci vrták



\*\*\*\*\*

**EzyChange sada vykružovacích korúnok** E-12310 143,99 € (MOC s DPH)

elektrikárska  
ø 16, 20, 25, 32, 40, 51 mm,  
adaptér, strediaci vrták



\*\*\*\*\*

**EzyChange sada vykružovacích korúnok** E-12326 161,99 € (MOC s DPH)

elektrikárska  
ø 20, 25, 32, 40, 65 mm,  
adaptér, strediaci vrták



\*\*\*\*\*

# VŔTANIE: VYKRUŽOVACIE KORUNKY

ø mm	L1	Adaptér	ks/bal	Obj. č.	MOC s DPH
------	----	---------	--------	---------	-----------

## Bimetalové korunky kov + 5% kobalt

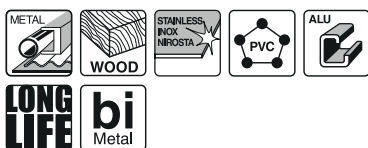

HSS Bi-Metal zub s premenlivým rozstupom 4-btpi s 5% obsahom kobaltu pre dlhšiu životnosť.

Vhodné na drevo, sadrokartón, plasty, neželezné kovy, hliník, oceľ a nehrdzavejúcu oceľ.

Priemery od 14 – 152 mm s šesťhrannými a SDS adaptéromi a navyše adaptéry so šesťhranným a SDS-Plus upínaním dlhý strediaci vrták.

14	38	P-35156 / P-35178	1	P-52451	7,99 €
16	38	P-35156 / P-35178	1	P-34936	8,69 €
17	38	P-35156 / P-35178	1	P-52467	8,69 €
19	38	P-35156 / P-35178	1	P-34942	8,69 €
20	38	P-35156 / P-35178	1	P-52473	8,59 €
21	38	P-35156 / P-35178	1	P-52489	8,99 €
22	38	P-35156 / P-35178	1	P-34958	9,29 €
24	38	P-35156 / P-35178	1	P-34964	9,89 €
25	38	P-35156 / P-35178	1	P-34970	9,89 €
27	38	P-35156 / P-35178	1	P-52495	9,89 €
29	38	P-35156 / P-35178	1	P-52504	9,89 €
30	38	P-35162 / P-35184	1	P-52510	9,89 €
32	38	P-35162 / P-35184	1	P-34986	10,99 €
33	38	P-35162 / P-35184	1	P-52526	10,99 €
35	38	P-35162 / P-35184	1	P-34992	11,99 €
37	38	P-35162 / P-35184	1	P-52532	11,99 €
38	38	P-35162 / P-35184	1	P-35003	11,99 €
40	38	P-35162 / P-35184	1	P-52548	11,99 €
41	38	P-35162 / P-35184	1	P-52554	11,99 €
43	38	P-35162 / P-35184	1	P-52560	11,99 €
44	38	P-35162 / P-35184	1	P-35019	12,99 €
46	38	P-35162 / P-35184	1	P-52576	12,99 €
48	38	P-35162 / P-35184	1	P-52582	12,99 €
51	38	P-35162 / P-35184	1	P-35025	13,99 €
52	38	P-35162 / P-35184	1	P-52598	13,99 €
54	38	P-35162 / P-35184	1	P-52607	14,99 €
57	38	P-35162 / P-35184	1	P-35031	15,99 €
59	38	P-35162 / P-35184	1	P-52613	15,99 €
60	38	P-35162 / P-35184	1	P-52629	15,99 €
64	38	P-35162 / P-35184	1	P-52635	15,99 €
65	38	P-35162 / P-35184	1	P-52641	16,99 €
67	38	P-35162 / P-35184	1	P-52657	16,99 €
68	38	P-35162 / P-35184	1	P-35047	16,99 €
70	38	P-35162 / P-35184	1	P-52663	17,99 €
73	38	P-35162 / P-35184	1	P-52679	17,99 €
76	38	P-35162 / P-35184	1	P-35053	18,99 €
79	38	P-35162 / P-35184	1	P-52685	18,99 €
83	38	P-35162 / P-35184	1	P-35069	19,99 €
86	38	P-35162 / P-35184	1	P-52691	20,99 €
89	38	P-35162 / P-35184	1	P-52700	20,99 €
92	38	P-35162 / P-35184	1	P-35075	21,99 €
95	38	P-35162 / P-35184	1	P-52716	22,99 €
98	38	P-35162 / P-35184	1	P-52722	23,99 €
102	38	P-35162 / P-35184	1	P-52738	23,99 €
105	38	P-35162 / P-35184	1	P-35081	26,99 €
108	38	P-35162 / P-35184	1	P-52744	27,99 €
111	38	P-35162 / P-35184	1	P-52750	28,99 €
114	38	P-35162 / P-35184	1	P-52766	29,99 €
121	38	P-35162 / P-35184	1	P-52772	31,99 €
127	38	P-35162 / P-35184	1	P-35097	34,99 €
140	38	P-35162 / P-35184	1	P-52788	42,99 €
146	38	P-35162 / P-35184	1	P-52794	46,99 €
152	38	P-35162 / P-35184	1	P-35106	51,99 €



P-35156



P-35162



P-35190



P-35178



ø mm	ø mm	Adaptér/ upínanie	ks/bal	Obj. č.	MOC s DPH
14 – 30	9,5	šesťhran	1	P-35156	12,99 €
32 – 210	11	šesťhran	1	P-35162	21,99 €
32 – 210	11	šesťhran	1	P-35190	21,99 €
14 – 30		SDS-Plus	1	P-35178	21,99 €
32 – 210		SDS-Plus	1	P-35184	27,99 €
	83	centrovací vrták	1	P-35209	6,59 €
	102	centrovací vrták	1	P-35215	6,99 €

## Max rýchlosť vrtania

ø mm	oceľ	meď	hliník	inox	drevo
16	530	730	825	275	3000
19	460	600	690	230	3000
20	440	580	675	220	3000
22	390	520	585	195	3000
24	370	490	555	185	2700
25	350	470	525	175	2700
29	300	400	450	150	2700
30	285	380	425	145	2400
32	275	360	410	140	2400
35	250	330	375	125	2400
38	230	300	345	115	2400
41	210	280	315	105	2100
44	195	260	295	95	2100
48	180	240	270	90	2100

ø mm	oceľ	meď	hliník	inox	drevo
57	170	230	255	85	2000
57	150	200	225	75	2000
60	140	190	220	70	2000
64	135	180	205	65	1850
68	130	170	190	65	1800
70	125	160	185	60	1800
76	115	150	170	55	1800
83	105	140	155	50	1500
92	90	120	140	45	1200
102	85	110	130	40	1000
105	85	110	130	40	1000
127	80	110	120	40	1000
152	65	90	90	30	800

# VŔTANIE: VYKRUŽOVACIE KORUNKY

## Vykružovacie korunky EZYCHANGE Bi-Metal 8%Co

\*\*\*\*\*

# Ezychange



HSS Bi-Metal Ezychange vykružovacie korunky  
Potrebný je iba jeden adaptér pre veľkosti 16 – 152 mm s rýchloupínacím strediacim vŕtákom.

Vyrobený z HSS Bi-Metal s 8% kobaltu a progresívnou geometriou zubov zaručuje dlhú životnosť a vysokú rýchlosť rezania. Vhodné pre železné a neželezné kovy, nehrdzavejúcu oceľ, hliník, drevo a plasty.

Korunky Ezychange je možné zakúpiť jednotlivo, alebo ako súpravu navrhnutú v tých správnych veľkostiach, ktoré vyhovujú vášmu remeslu. Kompatibilné s inými významnými výrobcami rýchlo vymeniteľných korúniek.

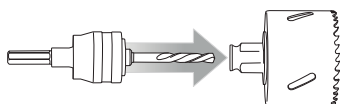

ø mm	ø mm	Adaptér/ upínanie	ks/bal	Obj. č.	MOC s DPH
		EzyChange adaptér centrovací vŕtáka HSS-G	1	E-04070	33,99 €
6,35	85	centrovací vŕtáka HSS-G	1	E-04086	10,29 €
6,35	85	centrovací vŕtáka HSS-CO	1	E-04092	11,99 €

ø mm	L1	Adaptér	ks/bal	Obj. č.	MOC s DPH
16	44	E-04070	1	E-03632	10,19 €
17	44	E-04070	1	E-03648	11,99 €
19	44	E-04070	1	E-03654	10,49 €
20	44	E-04070	1	E-03660	11,99 €
22	44	E-04070	1	E-03676	11,99 €
24	44	E-04070	1	E-03682	11,99 €
25	44	E-04070	1	E-03698	12,99 €
27	44	E-04070	1	E-03707	11,99 €
29	44	E-04070	1	E-03713	23,99 €
30	44	E-04070	1	E-03729	13,99 €
32	44	E-04070	1	E-03735	14,99 €
35	44	E-04070	1	E-03741	14,99 €
37	44	E-04070	1	E-03757	12,99 €
38	44	E-04070	1	E-03763	15,99 €
40	44	E-04070	1	E-03779	15,99 €
41	44	E-04070	1	E-03785	16,99 €
44	44	E-04070	1	E-03791	15,99 €
46	44	E-04070	1	E-03800	14,99 €
48	44	E-04070	1	E-03816	17,99 €
51	44	E-04070	1	E-03822	17,99 €
52	44	E-04070	1	E-03838	17,99 €
54	44	E-04070	1	E-03844	18,99 €
56	44	E-04070	1	E-03850	17,99 €
57	44	E-04070	1	E-03866	21,99 €
60	44	E-04070	1	E-03872	22,99 €
64	44	E-04070	1	E-03888	22,99 €
65	44	E-04070	1	E-03894	23,99 €
68	44	E-04070	1	E-03903	23,99 €
70	44	E-04070	1	E-03919	23,99 €
73	44	E-04070	1	E-03925	24,99 €
76	44	E-04070	1	E-03931	23,99 €
79	44	E-04070	1	E-03947	23,99 €
83	44	E-04070	1	E-03953	24,99 €
86	44	E-04070	1	E-03969	21,99 €
92	44	E-04070	1	E-03975	26,99 €
95	44	E-04070	1	E-03981	26,99 €
102	44	E-04070	1	E-03997	37,99 €
105	44	E-04070	1	E-04008	36,99 €
111	44	E-04070	1	E-04014	40,99 €
114	44	E-04070	1	E-04020	46,99 €
121	44	E-04070	1	E-04036	49,99 €
127	44	E-04070	1	E-04042	60,99 €
133	44	E-04070	1	E-14174	59,99 €
140	44	E-04070	1	E-04058	60,99 €
152	44	E-04070	1	E-04064	60,99 €



**Ezychange**  
**Bi-Metal HSS 8%Co**

# VŔTANIE: VYKRUŽOVACIE KORUNKY

**Sada koruniiek 10 ks** **D-51281** **123,99 €** (MOC s DPH)

22, 25, 29, 35, 38, 45, 51mm  
strediaci vrták 10x100mm  
TCT strediaci vrták 8x100mm  
13mm Hex adaptér



\*\*\*

**Sada koruniiek 9 ks** **D-51297** **174,99 €** (MOC s DPH)

22, 35, 51, 57, 64, 76mm  
strediaci vrták 10x100mm  
TCT strediaci vrták 8x100mm  
13mm Hex adaptér



\*\*\*

## Diamantové vrtáky na kachličky



Na kachličky a dlažbu pre uhlové brúsky  
pre uhlové brúsky, na sucho, uchytenie M14, max.  
otáčky 12 000 min<sup>-1</sup>

ø mm	Obj. č.	MOC s DPH
M14 × 25 mm	D-35025	24,99 €
M14 × 30 mm	D-35019	27,99 €
M14 × 35 mm	D-35003	28,99 €
M14 × 40 mm	D-37007	37,99 €
M14 × 45 mm	D-37013	43,99 €

## Diamantové vrtáky na kachličky, mramor, granit

Pre uhlové brúsky, na sucho, uchytenie M14, max. otáčky 12 000 min<sup>-1</sup>



ø mm	Obj. č.	MOC s DPH
5	D-61064	16,99 €
6	D-61070	16,99 €
8	D-61086	17,99 €
10	D-61092	18,99 €
12	D-61101	20,99 €
14	D-44432	49,99 €
16	D-44448	37,99 €
20	D-44454	25,99 €
22	D-44460	28,99 €
25	D-44476	32,99 €
27	D-44482	31,99 €
30	D-44498	42,99 €
32	D-44507	44,99 €
35	D-44513	46,99 €
38	D-44529	51,99 €
40	D-44535	57,99 €
45	D-44541	66,99 €
51	D-44557	69,99 €
60	D-44585	83,99 €
67	D-44600	88,99 €
68	D-44616	94,99 €
70	D-44622	100,99 €
75	D-44638	94,99 €
80	D-44644	104,99 €
83	D-44650	96,99 €

# VŔTANIE: VYKRUŽOVACIE KORUNKY

## Vykružovacie korunky

Diamantové korunky do tehly, pórobetonu, kachličiek a mramoru



ø mm	L1 mm	odporúčane otáčky	ks/bal	Obj. č.	MOC s DPH
------	-------	-------------------	--------	---------	-----------

19	40	3 000 – 5 000 min	1	B-46006	24,99 €
25	40	3 000 – 5 000 min	1	B-46012	31,99 €
30	40	3 000 – 5 000 min	1	B-46028	41,99 €
32	40	3 000 – 5 000 min	1	B-46034	41,99 €
35	40	3 000 – 5 000 min	1	B-46040	38,99 €
50	40	3 000 – 5 000 min	1	B-46078	68,99 €
57	40	3 000 – 5 000 min	1	B-46090	78,99 €
64	40	3 000 – 5 000 min	1	B-46109	80,99 €
68	40	3 000 – 5 000 min	1	B-53914	99,99 €

Pre uchytienie s valovitou stopkou

Rovná stopka a stredový vrták 182 / 59 mm M12 – M6	1	B-46115	12,99 €
Rovná stopka 182 mm M12 – M6	1	B-46137	9,39 €
Strediaci vrták 59 mm M6	1	B-46121	4,79 €

## Diamantové vrtáky na kachličky



ø mm	L1 mm	ks/bal	Obj. č.	MOC s DPH
------	-------	--------	---------	-----------

5	30	1	P-66569	9,99 €
6	30	1	P-66575	9,99 €
7	30	1	P-66581	14,99 €
8	30	1	P-66597	10,99 €
10	30	1	P-66612	12,99 €
12	30	1	P-66709	13,99 €
15	30	1	P-66715	15,99 €
20	30	1	P-66721	20,99 €

## Diamantové vrtáky na kachličky



22		1	P-70041	25,99 €
29		1	P-70057	31,99 €
35		1	P-70063	52,99 €
38		1	P-70079	33,99 €
64		1	P-70100	45,99 €

Upínací adaptér pre diamantový vrták

9,6 pre ø 19 – 29	1	P-35156	12,99 €
11 pre ø 35 – 64	1	P-35162	21,99 €

### Sada diamantových vrtákov 3 ks

P-66628

33,99 € (MOC s DPH)

ø 6, 8, 10 mm  
vodou chladené



### Sada diamantových vrtákov 3 ks

P-66983

53,99 € (MOC s DPH)

ø 15, 20, 25 mm  
vodou chladené



# VŔTANIE: VRTÁKY

ø mm	L1 mm	ks/bal	Obj. č.	MOC s DPH
------	-------	--------	---------	-----------

## Príkľepové vrtáky s valcovitou stopkou



Vrtáky s valcovou stopkou sú určené pre vrtanie do betónu, muríva, a prírodného kameňa. Špeciálna špirála v tvare U zaručuje efektívny odvod odvrátených častíc a dlhú životnosť vrtáku.

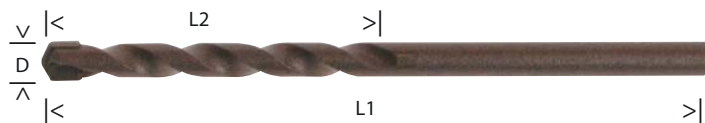

3	60	1	P-59592	0,89 €
4	75	1	P-59601	1,09 €
5	85	1	P-59617	1,19 €
6	100	1	P-59623	1,29 €
6	200	1	P-59754	2,59 €
6	400	1	P-59798	3,89 €
7	100	1	P-59639	1,49 €
8	120	1	P-59645	1,69 €
8	200	1	P-59760	3,09 €
8	400	1	P-59807	4,69 €
8	600	1	P-59900	8,09 €
9	120	1	P-59651	1,89 €
10	120	1	P-59667	2,19 €
10	200	1	P-59776	3,49 €
10	400	1	P-59813	5,39 €
10	600	1	P-59916	9,09 €
12	150	1	P-59689	3,29 €
12	200	1	P-59782	4,49 €
12	400	1	P-59829	6,59 €
12	600	1	P-59922	10,69 €
13	150	1	P-59695	3,99 €
14	150	1	P-59704	4,29 €
14	400	1	P-59835	8,29 €
16	400	1	P-59841	9,99 €

## Univerzálne vrtáky s valcovitou stopkou



Univerzálne vrtáky s valcovou stopkou určené na vrtanie do betónu, kachličiek, tehly, keramiky, dreva, plastu, hliníku a železa.



3	60	1	D-30287	0,99 €
4	70	1	D-30293	0,89 €
5	85	1	D-30302	1,19 €
6	100	1	D-30318	0,89 €
6	150	1	D-30324	0,89 €
6,5	100	1	D-31061	0,69 €
6,5	150	1	D-31077	1,09 €
7	150	1	D-30346	1,09 €
8	110	1	D-30352	0,99 €
8	150	1	D-30368	1,29 €
10	150	1	D-30380	1,59 €
10	400	1	D-30396	4,09 €
12	150	1	D-30411	1,79 €
12	600	1	D-30433	7,89 €
13	150	1	D-30449	2,09 €
14	150	1	D-30455	2,39 €

## Univerzálne vrtáky s 1/4" upínaním



Univerzálne vrtáky s 1/4" upínaním určené na vrtanie do kachličiek, tehly, keramiky, dreva, plastu, hliníku a železa.



3	90	1	E-14934	1,99 €
4	90	1	E-14940	1,89 €
5	100	1	E-14956	2,19 €
6	100	1	E-14984	2,29 €
6	150	1	E-14990	2,59 €
8	120	1	E-15045	3,19 €
8	150	1	E-15051	3,39 €
10	150	1	E-15067	3,99 €
12	150	1	E-15073	5,19 €

# VŔTANIE: VRTÁKY

ø mm	L1 mm	L2 mm	ks/bal	Obj. č.	MOC s DPH
------	-------	-------	--------	---------	-----------

## Vrtáky do tehly s valcovitou stopkou



3	60	30	1	D-40727	0,59 €
3,5	75	40	1	D-40733	0,59 €
4	75	40	1	D-40749	0,69 €
5	85	50	1	D-40761	0,69 €
5	150	90	1	D-40777	0,79 €
6	100	60	1	D-40808	0,89 €
6	150	90	1	D-40814	0,99 €
6	200	130	1	D-40820	1,19 €
6	400	300	1	D-40836	1,99 €
6,5	100	60	1	D-40842	0,59 €
8	120	80	1	D-40901	0,89 €
8	150	90	1	D-40917	1,29 €
8	200	130	1	D-40923	1,59 €
8	400	300	1	D-40939	9,09 €
9	120	80	1	D-40945	0,89 €
10	150	90	1	D-40967	1,29 €
10	200	130	1	D-40973	2,09 €
10	400	300	1	D-40989	2,89 €
12	200	130	1	D-41012	2,09 €
12	400	300	1	D-41028	3,69 €

### Sada vrtákov HM CT do muriva s valcovitou stopkou E-11536 9,59 € (MOC s DPH)

- 4 x 70 mm
- 5 x 85 mm
- 6 x 100 mm
- 8 x 110 mm
- 10 x 150mm



### Sada vrtákov TCT s valcovitou stopkou E-14255 15,99 € (MOC s DPH)

- Ø4 x 75 mm
- Ø5 x 80 mm
- Ø6 x 100 mm
- Ø8 x 120 mm
- Ø10 x 150 mm

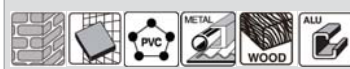

### Sada vrtákov TCT s valcovitou stopkou pre rôzne druhy materiálov E-15855 24,99 € (MOC s DPH)

- Ø3 x 70 mm; Ø6 x 150 mm
- Ø4 x 75 mm; Ø8 x 120 mm
- Ø5 x 85 mm; Ø8 x 150 mm
- Ø6 x 100 mm; Ø10 x 150 mm

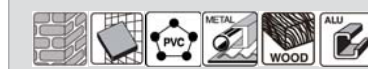



# PRÍSLUŠENSTVO

## ▣ Vrtanie (búranie)

# NEMESIS II



Železo, mäkká oceľ



Betón



PVC



Samoostrenie



Hliník



Armovaný betón



Asfalt



Menej prachu



Drevo



Tehla



Dvoj brit



Hrot z karbidu volfrámu



Obklad



Žula



Štvor brit

# VŔTANIE: PRÍKLEPOVÉ VRTÁKY SDS-PLUS

## NEMESIS II SDS-PLUS 4brit

# NEMESIS II



### Sada vrtákov SDS – plus 4 brit

**E-14249 17,99 €** (MOC s DPH)

- Ø5 x 110 mm
- Ø6 x 160 mm
- Ø8 x 160 mm
- Ø10 x 160 mm



ø mm	L1 mm	L2 mm	ks/bal	Obj. č.	MOC s DPH
5	115	50	1	B-57897	5,19 €
5	165	100	1	B-57906	5,59 €
5	215	150	1	B-57912	8,39 €
5,5	115	50	1	B-57940	5,29 €
5,5	165	100	1	B-57956	5,59 €
6	115	50	1	B-57962	5,29 €
6	165	100	1	B-57978	5,59 €
6	215	150	1	B-57984	7,29 €
6	265	200	1	B-57990	9,09 €
6	315	250	1	B-58001	12,99 €
6,5	165	100	1	B-58023	7,39 €
6,5	215	150	1	B-58039	9,99 €
6,5	265	200	1	B-58045	12,99 €
6,5	315	250	1	B-58051	14,99 €
7	115	50	1	B-58067	6,39 €
7	165	100	1	B-58073	7,29 €
7	215	150	1	B-58089	9,29 €
8	115	50	1	B-58095	6,09 €
8	165	100	1	B-58104	6,49 €
8	215	150	1	B-58110	7,39 €
8	265	200	1	B-58126	9,09 €
8	315	250	1	B-58132	12,99 €
8	465	400	1	B-58154	19,99 €
9	165	100	1	B-58176	6,99 €
9	265	200	1	B-58182	8,59 €
10	115	50	1	B-58198	6,69 €
10	165	100	1	B-58207	7,19 €
10	215	150	1	B-58213	8,29 €
10	265	200	1	B-58229	9,49 €
10	315	250	1	B-58235	11,99 €
10	455	390	1	B-58257	20,99 €
10	600	540	1	B-58263	27,99 €
10	1000	940	1	B-58279	64,99 €
11	160	110	1	E-14495	8,39 €
11	210	160	1	E-14504	9,69 €
11	260	210	1	E-14510	11,99 €
11	310	260	1	B-58316	15,99 €
12	160	110	1	E-14532	7,89 €
12	165	100	5	E-14794	37,99 €
12	215	150	5	E-14803	47,99 €
12	265	200	5	E-14819	54,99 €
12	165	100	10	E-14825	75,99 €
12	215	150	10	E-14831	91,99 €
12	265	200	10	E-14847	102,99 €
12	315	250	10	E-14853	142,99 €
12	210	160	1	E-14548	9,69 €
12	260	210	1	E-14554	11,99 €
12	310	260	1	E-14560	15,99 €
12	450	400	1	E-14576	22,99 €
12	600	550	1	E-14582	29,99 €
12	1000	950	1	E-19598	68,99 €
13	210	160	1	B-58403	17,99 €
13	260	210	1	B-58419	19,99 €
13	310	260	1	E-14629	20,99 €
14	165	100	10	E-14869	106,99 €
14	215	150	10	E-14875	144,99 €
14	265	200	10	E-14881	168,99 €
14	315	250	10	E-14897	177,99 €
14	160	110	1	E-14635	11,99 €
14	210	160	1	E-14641	15,99 €
14	260	210	1	E-14657	17,99 €
14	310	260	1	E-14663	18,99 €
14	450	400	1	E-14679	23,99 €
14	600	550	1	E-14685	31,99 €
14	1000	950	1	B-58497	73,99 €
15	160	110	1	E-14691	16,99 €
15	210	160	1	E-14700	19,99 €
15	260	210	1	E-14716	20,99 €
15	450	400	1	B-58534	26,99 €
16	160	110	1	E-14738	17,99 €
16	210	160	1	E-14744	20,99 €
16	260	210	1	E-14750	22,99 €
16	310	260	1	E-14766	24,99 €
16	450	400	1	E-14772	29,99 €
16	600	550	1	E-14788	38,99 €
16	1000	950	1	E-19613	80,99 €
18	250	200	1	B-58615	30,99 €
18	450	400	1	B-58621	34,99 €
20	250	200	1	B-58637	33,99 €
20	450	400	1	B-58659	40,99 €
22	250	200	1	B-58665	36,99 €
22	450	400	1	B-58687	48,99 €
24	250	200	1	B-58693	46,99 €
24	450	400	1	B-58702	52,99 €
25	250	200	1	B-58718	46,99 €
25	450	400	1	B-58724	60,99 €
28	250	200	1	B-58746	58,99 €
28	450	400	1	B-58752	72,99 €
30	250	200	1	B-58768	60,99 €
30	450	400	1	B-58774	74,99 €
32	450	400	1	B-58780	82,99 €

# VŔTANIE: PRÍKLEPOVÉ VRTÁKY SDS-PLUS

## NEMESIS II SDS-PLUS 4brit – sady



**Sada NEMESIS II** **B-58986** **16,99 €** (MOC s DPH)

5 × 110 mm 1 ks  
6 × 110 mm 1 ks  
8 × 110 mm 1 ks

**Sada NEMESIS II** **B-59075** **20,99 €** (MOC s DPH)

6 × 160 mm 1 ks  
8 × 160 mm 1 ks  
10 × 160 mm 1 ks

**Sada NEMESIS II** **B-58992** **30,99 €** (MOC s DPH)

5 × 110 mm 1 ks  
6 × 110 mm 1 ks  
6 × 160 mm 1 ks  
8 × 160 mm 1 ks  
10 × 160 mm 1 ks

**Sada NEMESIS II** **E-14912** **78,99 €** (MOC s DPH)

5 × 160 mm 1 ks  
6 × 160 mm 3 ks  
8 × 160 mm 3 ks  
10 × 160 mm 3 ks  
12 × 160 mm 2 ks

**Sada NEMESIS II** **E-14928** **52,99 €** (MOC s DPH)

5 × 110 mm 1ks  
6 × 110 mm 1 ks  
8 × 110 mm 1ks  
6 × 160 mm 1ks  
8 × 160 mm 1ks  
10 × 160 mm 1ks  
12 × 160mm 1 ks

**Sada NEMESIS II** **B-58827** **27,99 €** (MOC s DPH)

6 × 160 mm 5 ks / bal

**Sada NEMESIS II** **B-58899** **31,99 €** (MOC s DPH)

8 × 160 mm 5 ks / bal

**Sada NEMESIS II** **B-58914** **34,99 €** (MOC s DPH)

10 × 160 mm 5 ks / bal

ø mm	L1 mm	L2 mm	ks/bal	Obj. č.	MOC s DPH
------	-------	-------	--------	---------	-----------

## Príklepové vrtáky SDS-PLUS 4brit



6	110	50	1	B-62496	3,39 €
6	160	100	1	B-62505	2,79 €
6	210	150	1	B-62511	3,49 €
6	260	200	1	B-62527	3,69 €
8	160	100	1	B-62614	3,59 €
8	210	150	1	B-62620	4,29 €
8	260	200	1	B-62636	4,39 €
8	310	250	1	B-62642	4,99 €
8	460	400	1	B-62658	7,89 €
10	160	100	1	B-62670	4,69 €
10	210	150	1	B-62686	5,19 €
10	260	200	1	B-62692	6,09 €
10	310	250	1	B-62701	6,59 €
10	350	290	1	B-62717	6,39 €
10	460	400	1	B-62723	10,19 €
12	210	150	1	B-62745	6,89 €
12	260	200	1	B-62751	8,79 €
12	460	400	1	B-62789	12,99 €

## VŔTANIE: PRÍKLEPOVÉ VRTÁKY SDS-PLUS

Ideálne vrtáky na vrtanie s príklepom do betónu, muriva a prírodného kameňa. Moderné tepelné spracovanie a špeciálna technológia kalenia povrchu znižujú opotrebovanie a zaručujú vysokú húževnatosť a odolnosť vrtákov voči namáhaniu ohybom. Vhodné pre vrtacie kladivá triedy 2 – 4 kg.

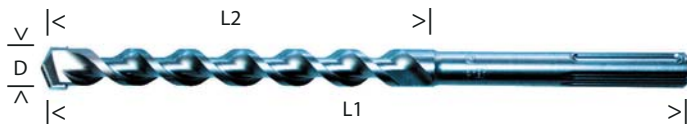

Ø mm	L1 mm	L2 mm	ks/bal	Obj. č.	MOC s DPH	Ø mm	L1 mm	L2 mm	ks/bal	Obj. č.	MOC s DPH
------	-------	-------	--------	---------	-----------	------	-------	-------	--------	---------	-----------

### Príklepové vrtáky SDS-Plus V Plus



4	110	50	1	B-47232	3,19 €	14	450	400	1	B-47830	13,99 €
4	160	100	1	B-47248	3,99 €	14	600	550	1	B-47846	18,99 €
5	110	50	1	B-46492	2,69 €	14	1000	950	1	B-47852	46,99 €
5	160	100	1	B-46501	3,19 €	15	160	110	1	B-47868	7,29 €
5	210	150	1	B-47260	5,09 €	15	210	160	1	B-47874	9,19 €
5	310	250	1	B-47282	6,49 €	15	260	210	1	B-47880	10,29 €
5,5	110	50	1	B-47298	2,89 €	15	450	400	1	B-47896	14,99 €
5,5	160	100	1	B-47307	3,69 €	16	160	110	1	B-47905	8,09 €
5,5	210	150	1	B-47313	5,09 €	16	210	160	1	B-47911	9,09 €
5,5	260	200	1	B-47329	6,09 €	16	260	210	1	B-47927	10,79 €
6	110	50	1	B-46517	2,59 €	16	310	260	1	B-47933	12,99 €
6	160	100	1	B-46523	2,79 €	16	450	400	1	B-47949	16,99 €
6	210	150	1	B-47341	4,29 €	16	600	550	1	B-47955	20,99 €
6	260	200	1	B-47357	5,39 €	16	800	750	1	B-47961	31,99 €
6	310	250	1	B-47363	8,99 €	16	1000	950	1	B-47977	47,99 €
6	460	400	1	B-47379	13,99 €	18	200	150	1	B-48000	14,99 €
6,5	160	100	1	B-47391	3,59 €	18	300	250	1	B-48016	17,99 €
6,5	210	150	1	B-47400	4,59 €	18	450	400	1	B-48022	21,99 €
6,5	260	200	1	B-47416	6,69 €	18	600	550	1	B-48038	30,99 €
6,5	310	250	1	B-47422	9,69 €	18	1000	950	1	B-48044	56,99 €
7	160	100	1	B-47444	3,29 €	20	200	150	1	B-48072	17,99 €
7	210	150	1	B-47450	4,89 €	20	300	250	1	B-48088	20,99 €
7	250	190	1	B-47466	6,89 €	20	450	400	1	B-48094	25,99 €
8	110	50	1	B-46539	3,09 €	20	600	550	1	B-48103	35,99 €
8	160	100	1	B-46545	3,39 €	20	800	750	1	B-48119	61,99 €
8	210	150	1	B-47472	4,19 €	20	1000	950	1	B-48125	65,99 €
8	260	200	1	B-47488	4,89 €	22	250	200	1	B-48131	24,99 €
8	310	250	1	B-47494	6,69 €	22	450	400	1	B-48147	33,99 €
8	400	340	1	B-47503	9,99 €	22	600	550	1	B-48153	44,99 €
8	460	400	1	B-47519	10,39 €	22	1000	950	1	B-48169	69,99 €
8	600	540	1	B-47525	15,99 €	24	250	200	1	B-48197	29,99 €
9	160	100	1	B-47531	4,39 €	24	450	400	1	B-48206	37,99 €
9	210	150	1	B-47547	5,59 €	24	600	550	1	B-48212	44,99 €
10	110	50	1	B-46551	3,19 €	25	250	200	1	B-48228	32,99 €
10	160	100	1	B-46567	3,69 €	25	450	400	1	B-48234	37,99 €
10	210	150	1	B-47569	4,79 €	25	600	550	1	B-48240	57,99 €
10	260	200	1	B-47575	5,39 €	25	1000	950	1	B-48256	85,99 €
10	310	250	1	B-47581	6,89 €	26	250	200	1	B-48262	31,99 €
10	350	290	1	B-47597	9,39 €	26	450	400	1	B-48278	39,99 €
10	450	390	1	B-47606	10,29 €						
10	600	540	1	B-47612	15,99 €						
10	800	740	1	B-47628	23,99 €						
10	1000	940	1	B-47634	39,99 €						
11	160	110	1	B-47640	4,89 €						
11	210	160	1	B-47656	6,19 €						
11	260	210	1	B-47662	7,39 €						
11	310	260	1	B-47678	9,29 €						
12	160	110	1	B-46573	4,49 €						
12	210	160	1	B-47684	5,49 €						
12	260	210	1	B-47690	7,09 €						
12	310	260	1	B-47709	8,89 €						
12	360	310	1	B-47715	10,99 €						
12	450	400	1	B-47721	12,99 €						
12	600	550	1	B-47737	16,99 €						
12	800	750	1	B-47743	27,99 €						
12	1000	950	1	B-47759	43,99 €						
13	210	160	1	B-47771	6,89 €						
14	160	110	1	B-46589	6,19 €						
14	210	160	1	B-47802	7,09 €						
14	260	210	1	B-47818	8,59 €						
14	310	260	1	B-47824	9,59 €						

#### Sada vrtákov SDS plus 2 brit

D-74136

9,49 € (MOC s DPH)

5 x 110 mm  
6 x 160 mm  
8 x 160 mm  
10 x 160 mm



#### Sada vrtákov SDS plus 2 brit

D-74756

10,39 € (MOC s DPH)

Ø 6; 8; 10; 12 x 160 mm



# VŔTANIE: PRÍKLEPOVÉ VRTÁKY SDS-PLUS

ø mm	L1 mm	L2 mm	ks/bal	Obj. č.	MOC s DPH
------	-------	-------	--------	---------	-----------

## Príklepové vrtáky SDS-Plus V Plus



Ideálne vrtáky na vrtanie s príklepom do betónu, muriva a prírodného kameňa. Moderné tepelné spracovanie a špeciálna technológia kalenia povrchu znižujú opotrebovanie a zaručujú vysokú húževnatosť a odolnosť vrtákov voči namáhaniu ohybom. Vhodné pre vrtacie kladivá triedy 2 – 4 kg.



5	110	50	5	B-46492-5	11,99 €
6	110	50	5	B-46517-5	12,99 €
6	160	100	5	B-46523-5	13,99 €
6	210	150	5	B-47341-5	19,99 €
8	110	50	5	B-46539-5	14,99 €
8	160	100	5	B-46545-5	16,99 €
8	210	150	5	B-47472-5	19,99 €
10	160	100	5	B-46567-5	18,99 €
10	210	150	5	B-47569-5	25,99 €
12	160	110	5	B-46573-5	21,99 €
12	210	160	5	B-47684-5	29,99 €
6	110	50	10	B-46517-10	28,99 €
6	210	200	10	B-47341-10	42,99 €
8	160	100	10	B-46545-10	31,99 €
8	210	150	10	B-47472-10	45,99 €
10	160	110	10	B-46567-10	44,99 €
6	160	100	25	B-46523-25	68,99 €
8	210	150	25	B-47472-25	100,99 €
10	210	150	25	B-47569-25	119,99 €
6	110	50	50	B-46517-50	117,99 €
6	160	100	50	B-46523-50	134,99 €
8	160	100	50	B-46545-50	159,99 €
8	210	150	50	B-47472-50	208,99 €
10	160	100	50	B-46567-50	180,99 €

**Sada vrtákov SDS-Plus V-Plus B-49052 14,99 € (MOC s DPH)**

- 5x110 1 ks
- 6x110 1 ks
- 8x110 1 ks
- 6x160 1 ks
- 8x160 1 ks

**Sada vrtákov SDS-Plus V-Plus B-49074 18,99 € (MOC s DPH)**

- 5x110 1 ks
- 6x160 1 ks
- 8x160 1 ks
- 10x160 1 ks
- 12x160 1 ks

**Sada vrtákov SDS-Plus V-Plus B-49080 46,99 € (MOC s DPH)**

- 6x110 1 ks
- 6x160 2ks
- 8x160 3 ks
- 10x160 2 ks
- 12x160 2 ks
- 14x160 1 ks
- 16x160 1 ks

**Sada vrtákov SDS-Plus V-Plus B-49096 38,99 € (MOC s DPH)**

- 5x110 3 ks
- 6x160 4 ks
- 8x160 2 ks
- 10x160 2 ks
- 12x160 1 ks

**Sada vrtákov SDS-Plus V-Plus B-49105 42,99 € (MOC s DPH)**

- 6x160 3 ks
- 8x160 4 ks
- 10x160 3 ks
- 12x160 2 ks

**Sada vrtákov SDS-Plus V-Plus B-49133 14,99 € (MOC s DPH)**

- 5x110 1 ks
- 6x110 1 ks
- 6x160 1 ks
- 8x160 1 ks
- 10x160 1 ks

**Sada vrtákov SDS-Plus V-Plus B-49127 35,99 € (MOC s DPH)**

- 5x110 1 ks
- 6x110 1 ks
- 6x160 2 ks
- 8x160 2 ks
- 10x160 2 ks
- 10x210 1 ks
- 12x210 1 ks

**Sada vrtákov SDS-Plus V-Plus B-49046 31,99 € (MOC s DPH)**

- 5x110 1 ks
- 6x110 1 ks
- 6x160 1 ks
- 8x110 1 ks
- 8x160 1 ks
- 10x160 1 ks
- 12x160 1 ks

## Lahké príklepové vrtacie korunky SDS-Plus



Použitie do muriva, moderných ľahkých stavebných hmôt a betónu.



popis	ø mm	obj. č.	MOC s DPH
ľahké vrtacie korunky M16	40	P-26191	54,99 €
	50	P-26200	61,99 €
	65	P-26216	61,99 €
	80	P-26222	69,99 €
vystredovaci vrták pre vrtacie korunky		P-64347	5,29 €
upínacia stopka pre vrtacie korunky		P-67745	22,99 €

# VŔTANIE: PRÍKLEPOVÉ VRTÁKY SDS-PLUS

ø mm	L1 mm	L2 mm	ks/bal	Obj. č.	MOC s DPH
------	-------	-------	--------	---------	-----------

## Príkľepové vrtáky SDS-Plus V Plus



Vhodné na vrtanie s príklepom do betónu, muriva a prírodného kameňa. Tieto robustné príklepové vrtáky SDS-PLUS sú cenovo výhodnou alternatívou vrtákov SDS-PLUS S4. Sú optimálne pre príležitostné vrtanie.

ø mm	L1 mm	L2 mm	ks/bal	Obj. č.	MOC s DPH
4	160	100	1	D-66612	1,49 €
5	210	150	1	D-66628	1,89 €
6,5	260	200	1	D-66634	2,39 €
8	310	250	1	D-66640	3,29 €
10	350	290	1	D-66656	3,39 €
11	210	150	1	D-66662	2,29 €
11	260	200	1	D-66678	2,59 €
12	310	250	1	D-66684	3,19 €
13	210	150	1	D-66690	2,89 €
14	310	250	1	D-66709	4,09 €

**Sada vrtákov SDS-Plus V-Plus** **D-00795** **8,39 €** (MOC s DPH)

- 5 × 110 mm 1 ks
- 6 × 110 mm 1 ks
- 8 × 110 mm 1 ks
- 6 × 160 mm 1 ks
- 8 × 160 mm 1 ks

**Sada vrtákov SDS-Plus V-Plus** **D-62723** **21,99 €** (MOC s DPH)

- 6 × 160 mm 3 ks
- 8 × 160 mm 3 ks
- 10 × 160 mm 3 ks
- 12 × 160 mm 3 ks

**Sada vrtákov SDS-Plus V-Plus** **D-61678** **7,39 €** (MOC s DPH)

- 6 × 110 mm 1 ks
- 6 × 160 mm 1 ks
- 8 × 110 mm 1 ks
- 8 × 160 mm 1 ks
- 10 × 160 mm 1 ks

4	110	50	1	D-00016	1,69 €
5	110	50	1	D-00022	1,59 €
5	160	100	1	D-00038	1,89 €
5,5	110	50	1	D-00044	1,69 €
6	110	50	1	D-00050	1,69 €
6	160	100	1	D-00066	1,89 €
6	210	150	1	D-00072	2,19 €
6,5	110	50	1	D-00088	1,69 €
6,5	160	100	1	D-00094	1,69 €
7	110	50	1	D-00103	1,79 €
7	160	100	1	D-00119	1,69 €
8	110	50	1	D-00125	1,79 €
8	160	100	1	D-00131	1,89 €
8	210	150	1	D-00147	2,09 €
8	260	200	1	D-00153	2,39 €
9	210	150	1	D-00169	1,99 €
10	160	100	1	D-00175	1,79 €
10	210	150	1	D-00181	2,29 €
10	260	200	1	D-00197	2,59 €
10	310	250	1	D-00206	2,99 €
10	460	400	1	D-17538	5,99 €
11	160	100	1	D-00212	1,39 €
12	160	100	1	D-00228	2,09 €
12	210	150	1	D-00234	2,59 €
12	260	200	1	D-00240	3,19 €
12	460	400	1	D-16271	6,29 €
13	160	100	1	D-00256	1,99 €
14	160	100	1	D-00262	2,79 €
14	260	200	1	D-00278	3,59 €
14	460	400	1	D-17544	6,39 €
15	160	100	1	D-00284	3,49 €
15	460	400	1	D-17550	8,59 €
16	210	150	1	D-00290	4,09 €
16	460	400	1	D-16287	7,99 €
16	310	250	1	D-00309	5,59 €
18	210	150	1	D-00321	5,09 €
18	300	240	1	D-00337	6,19 €
18	460	400	1	D-17566	9,99 €
19	210	150	1	D-00343	3,69 €
19	460	400	1	D-16293	8,39 €
20	210	150	1	D-00359	6,39 €
20	310	250	1	D-00365	7,69 €
20	460	400	1	D-15235	9,99 €
22	260	200	1	D-00371	8,19 €
22	310	250	1	D-08062	8,69 €
22	460	400	1	D-15241	11,99 €
24	460	400	1	D-16302	12,99 €
25	260	200	1	D-00387	10,09 €
25	310	250	1	D-08517	10,99 €
25	460	400	1	D-15257	13,99 €
26	260	200	1	D-00393	11,99 €
26	310	250	1	D-08078	12,99 €
26	460	400	1	D-15263	15,99 €
28	460	400	1	D-16318	18,99 €
30	460	400	1	D-17572	24,99 €

**Sada vrtákov a sekáčov SDS-Plus V-Plus** **D-58920** **19,99 €** (MOC s DPH)

- 5 × 160 mm 1 ks
- 6 × 160 mm 1 ks
- 8 × 160 mm 1 ks
- sekáč špic 250 mm
- sekáč plochý 20 × 250 mm
- sekáč plochý 40 × 250 mm

## VŔTANIE: PRÍKLEPOVÉ VRTÁKY SDS-MAX



Štvorbřité vrtáky ZENTRO MAX sú dokonalou kombináciou nového inovatívneho tvaru hlavy vrtáka so špeciálnym tvarom špirály zaručujúcu nekompromisnú kvalitu v každom detaile. Tieto vrtáky sa vyznačujú veľmi dlhou životnosťou, veľkou presnosťou a ideálnym prenosom energie zo stroja na hrot vrtáku.

Kvalitu týchto vrtákov ocenia hlavne majstri, ktorí potrebujú vrtáť do tvrdých materiálov – betónu, železobetónu alebo prírodného kameňa.



Vrtáky sú cenovo výhodnou variantou a sú určené pre vrtanie do betónu, muriva a prírodného kameňa.

ø mm	L1 mm	L2 mm	ks/bal	Obj. č.	MOC s DPH
------	-------	-------	--------	---------	-----------

### Príklepové štvorbřité vrtáky ZENTRO MAX \*\*\*\*\*

12	*340	200	1	P-17033	35,99 €
12	*540	400	1	P-17049	43,99 €
12	*690	550	1	P-17055	58,99 €
14	*340	200	1	P-17077	38,99 €
14	*540	400	1	P-17083	45,99 €
15	*340	200	1	P-17108	37,99 €
16	340	200	1	P-77730	42,99 €
16	540	400	1	P-77746	46,99 €
16	920	800	1	P-77752	69,99 €
16	1320	1200	1	P-77768	169,99 €
18	340	200	1	P-77774	42,99 €
18	540	400	1	P-77780	48,99 €
18	920	800	1	P-77796	73,99 €
18	1320	1200	1	P-77805	175,99 €
20	320	200	1	P-77811	44,99 €
20	520	400	1	P-77827	51,99 €
20	920	800	1	P-77833	80,99 €
20	1320	1200	1	P-77849	171,99 €
22	520	400	1	P-77861	56,99 €
22	920	800	1	P-77877	83,99 €
24	320	200	1	P-77899	55,99 €
24	520	400	1	P-77908	63,99 €
25	320	200	1	P-77914	57,99 €
25	520	400	1	P-77920	62,99 €
25	920	800	1	P-77936	98,99 €
25	1320	1200	1	P-77942	204,99 €
26	520	400	1	P-77958	70,99 €
28	370	200	1	P-77964	62,99 €
28	570	450	1	P-77970	70,99 €
28	670	550	1	P-77986	96,99 €
28	920	800	1	P-77992	114,99 €
28	1320	1200	1	P-78003	213,99 €
30	370	250	1	P-78019	65,99 €
30	570	450	1	P-78025	76,99 €
32	370	250	1	P-78031	72,99 €
32	570	450	1	P-78047	87,99 €
32	920	800	1	P-78053	135,99 €
32	1320	1200	1	P-78069	222,99 €
35	370	250	1	P-78075	78,99 €
35	570	450	1	P-78081	98,99 €
35	670	550	1	P-78097	119,99 €
35	1320	1200	1	P-78592	245,99 €
37	570	450	1	P-78112	116,99 €
37	920	800	1	P-78128	167,99 €
38	370	250	1	P-78134	97,99 €
38	570	450	1	P-78140	123,99 €
40	370	250	1	P-78156	115,99 €
40	570	450	1	P-78162	146,99 €
40	920	800	1	P-78178	202,99 €
40	1320	1200	1	P-78184	271,99 €
45	570	450	1	B-20323	227,99 €
45	920	800	1	P-78209	256,99 €
50	570	450	1	P-78215	237,99 €
52	570	450		P-78221	244,99 €

ø mm	L1 mm	L2 mm	ks/bal	Obj. č.	MOC s DPH
------	-------	-------	--------	---------	-----------

### Príklepové vrtáky SDS-MAX V-Plus \*\*\*\*\*

12	340	200	1	D-33875	13,99 €
12	540	400	1	D-33881	18,99 €
14	340	200	1	D-33897	13,99 €
14	540	400	1	D-33906	18,99 €
15	340	200	1	D-33912	11,99 €
15	540	400	1	D-33928	16,99 €
16	340	200	1	D-33934	14,99 €
16	540	400	1	D-33940	20,99 €
18	340	200	1	D-33956	18,99 €
18	540	400	1	D-33962	21,99 €
20	340	200	1	D-33978	20,99 €
20	540	400	1	D-33984	24,99 €
22	340	200	1	D-33990	20,99 €
22	540	400	1	D-34001	27,99 €
24	340	200	1	D-34017	20,99 €
24	540	400	1	D-34023	28,99 €
25	340	200	1	D-34039	24,99 €
25	540	400	1	D-34045	29,99 €
28	370	250	1	D-34051	26,99 €
28	570	450	1	D-34067	37,99 €
30	370	250	1	D-34073	30,99 €
30	570	450	1	D-34089	51,99 €
32	370	250	1	D-34095	40,99 €
32	570	450	1	D-34104	53,99 €
35	370	250	1	D-34110	46,99 €
35	570	450	1	D-34126	58,99 €
38	370	250	1	D-34132	63,99 €
38	570	450	1	D-34148	71,99 €
40	370	250	1	D-34154	70,99 €
40	570	450	1	D-34160	79,99 €

#### Adaptér SDS-MAX na SDS-PLUS P-17027 88,99 € (MOC s DPH)



#### Rýchloskľučovadlo s upínaním SDS-Max 122829-5 66,99 € (MOC s DPH)



\*Priemery 12 – 15 mm sa dodávajú s dvomi ostriami.

## VŔTANIE: VŔTANIE SDS-MAX

ø mm	L1 mm	L2 mm	ks/bal	Obj. č.	MOC s DPH
------	-------	-------	--------	---------	-----------

### Vŕtacie korunky SDS-MAX



Vŕtacie korunky Makita sú ideálne vhodné na vŕtanie do betónu, muriva a prírodného kameňa. Veniec vŕtacej korunky je osadený symetricky usporiadanými, pevnými špeciálnymi zubami z tvrdého kovu. Priamy prenos energie príklepu umožňuje dosahovať rýchly postup vŕtania. Účinná vonkajšia drážka v tvare špirály minimalizuje straty trením, umožňuje rýchly odsun odvráteného prachu a je zárukou dlhšej životnosti.



50	100		1	P-03785	102,99 €
65	100		1	P-03791	139,99 €
68	100		1	P-73433	131,99 €
80	100		1	P-03800	145,99 €
100	100		1	P-03822	184,99 €
110	100		1	P-73449	215,99 €
125	100		1	P-16374	274,99 €
vystreďovací vŕták pre vŕtacie korunky		11 x 120	1	P-03838	8,89 €
upínacia stopka pre vŕtacie korunky		180	1	P-16994	49,99 €
		450	1	P-17005	72,99 €

68	80	290	1	P-64406	194,99 €
----	----	-----	---	---------	----------

Potrebné dokúpiť strediaci vŕták P-03838

### Prerážacie vŕtáky SDS-MAX



Výkonové parametre prerážacích vŕtákov Makita do betónu:

- Rýchla montáž – nástroj je z jedného kusu
- Vyvŕtanie celého priemeru – vylamovanie jadra nie je potrebné
- Jednodielná konštrukcia umožňuje prenos energie príklepu na špičku nástroja bez strát v dôsledku útlmu
- Variabilná hĺbka vrtu podľa dĺžky stopky
- Rovná a okrúhla diera s plochým dnom
- Výrazne vyšší vŕtací výkon ako s vŕtacími korunkami



55	prerážacie vŕtáky so závitovým čapom		1	P-04014	210,99 €
60			1	P-04020	227,99 €
predĺženie Ratio pre prerážacie vŕtáky		280	1	P-03925	105,99 €
upínacia stopka pre prerážacie vŕtáky		185	1	P-03888	64,99 €
závitový čap		60	1	P-03931	14,99 €

40		550	1	B-57629	200,99 €
45		550	1	E-20096	218,99 €
45		990	1	E-20105	274,99 €
55		550	1	E-20111	253,99 €
55		990	1	E-20127	292,99 €
65		550	1	E-20133	275,99 €
65		990	1	E-20149	317,99 €
80		550	1	E-20155	307,99 €
80		990	1	E-20161	409,99 €

### System MAXCONNET

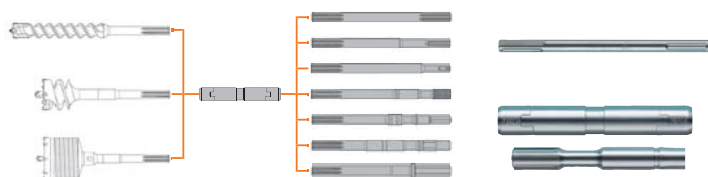

	320	predĺženie SDS-MAX = SDS-MAX	1	P-53920	30,99 €
	750	predĺženie SDS-MAX = SDS-MAX	1	P-53936	38,99 €
	1100	predĺženie SDS-MAX = SDS-MAX	1	P-53942	51,99 €
30	190	Adaptér SDS-MAX s klin. hriadeľom = SDS-MAX	1	P-53914	242,99 €



# SEKANIE: SEKÁČE SDS-PLUS

ø mm	L1 mm	L2 mm	ks/bal	Obj. č.	MOC s DPH
------	-------	-------	--------	---------	-----------

## Sekáče SDS-PLUS

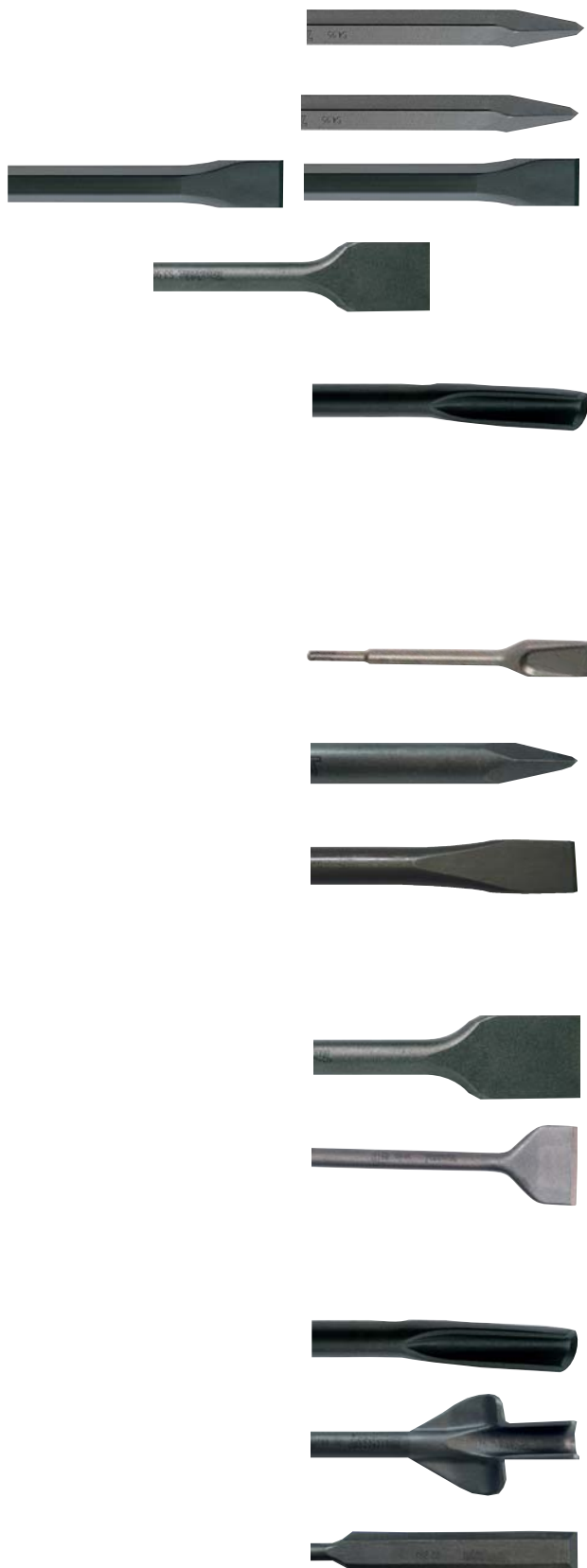

Sekáč špic SDS-PLUS so šesťhrannou stopkou **\*\*\*\*\***

250	190	1	P-05505	11,99 €
-----	-----	---	---------	---------

Sekáč špic SDS-PLUS so šesťhrannou stopkou **\*\*\***

400	340	1	D-19015	4,29 €
-----	-----	---	---------	--------

Sekáč plochý SDS-PLUS so šesťhrannou stopkou **\*\*\*\*\***

20	250	190	1	P-05511	11,99 €
----	-----	-----	---	---------	---------

40	250	190	1	P-05527	16,99 €
----	-----	-----	---	---------	---------

40	250	190	1	B-14059	16,99 €
----	-----	-----	---	---------	---------

Sekáč drážkovací SDS-PLUS so šesťhrannou stopkou **\*\*\*\*\***

22	250	190	1	P-05533	18,99 €
----	-----	-----	---	---------	---------

Sekáč plochý SDS-PLUS so šesťhrannou stopkou **\*\*\***

20	400	340	1	D-19021	4,49 €
----	-----	-----	---	---------	--------

20	250	190	1	D-08729	4,69 €
----	-----	-----	---	---------	--------

40	250	190	1	D-08735	6,09 €
----	-----	-----	---	---------	--------

50	250	190	1	D-78324	7,39 €
----	-----	-----	---	---------	--------

Sekáč špic SDS-PLUS s valcovitou stopkou **\*\*\*\*\***

250	190	1	P-25068	7,79 €
-----	-----	---	---------	--------

Sekáč plochý SDS-PLUS so valcovitou stopkou **\*\*\*\*\***

20	250	190	1	P-25074	7,79 €
----	-----	-----	---	---------	--------

40	250	190	1	A-30483	12,99 €
----	-----	-----	---	---------	---------

60	250	190	1	P-24935	19,99 €
----	-----	-----	---	---------	---------

Sekáč plochý SDS-PLUS s valcovitou stopkou **\*\*\***

80	250	190	1	D-61020	15,99 €
----	-----	-----	---	---------	---------

Sekáč plochý zahnutý SDS-PLUS s valcovitou stopkou **\*\*\*\*\***

40	250	190	1	P-24941	14,99 €
----	-----	-----	---	---------	---------

40	250	190	1	P-63987	19,99 €
----	-----	-----	---	---------	---------

60	250	190	1	P-24957	21,99 €
----	-----	-----	---	---------	---------

Sekáč drážkovací SDS-PLUS s valcovitou stopkou **\*\*\*\*\***

22	250	190	1	P-25080	14,99 €
----	-----	-----	---	---------	---------

Sekáč krídelkový SDS-PLUS s valcovitou stopkou **\*\*\*\*\***

22	250	190	1	P-24963	29,99 €
----	-----	-----	---	---------	---------

Dláto na dlabanie do dreva SDS-PLUS **\*\*\*\*\***

30	170	110	1	P-25111	34,99 €
----	-----	-----	---	---------	---------

**Sada sekáčov SDS-PLUS 3 ks E-20220 39,99 € (MOC s DPH)**

sekáč plochý 40 x 250 mm  
 sekáč plochý 20 x 250 mm  
 sekáč špic 250 mm

## Sekáče SDS-MAX



ø mm	L1 mm	L2 mm	ks/bal	Obj. č.	MOC s DPH
------	-------	-------	--------	---------	-----------

### Sekáč špic SDS-MAX



	280	220	1	P-16237	10,99 €
	400	330	1	P-16243	13,99 €
	600	520	1	P-16259	20,99 €

### Sekáč plochý SDS-MAX



25	280	220	1	P-16265	10,99 €
25	400	330	1	P-16271	13,99 €
25	600	520	1	P-16287	20,99 €
50	360	300	1	P-16302	18,99 €
80	300	240	1	P-16318	28,99 €

### Sekáč na kachličky SDS-MAX



50	300	240	1	P-16324	28,99 €
----	-----	-----	---	---------	---------

### Sekáč drážkovací SDS-MAX



26	300	120	1	P-16293	25,99 €
----	-----	-----	---	---------	---------

### Sekáč krídelkový SDS-MAX



35	360	190	1	P-16330	50,99 €
----	-----	-----	---	---------	---------

### Sekáč lopatka SDS-MAX



100	400		1	P-23721	65,99 €
-----	-----	--	---	---------	---------

### Sekáč škárový SDS-MAX



38	300		1	P-16346	70,99 €
----	-----	--	---	---------	---------

### Zarovnávací platnička



### Upínacia stopka pre zarovnávaciu platničku SDS-MAX

60	60	7 x 7 zubov	1	P-03947	84,99 €
	250		1	P-16352	33,99 €

### Sekáč špic SDS-MAX



	300	240	1	D-34176	7,29 €
	400	330	1	D-34182	8,09 €
	600	520	1	D-34198	12,99 €

### Sekáč plochý SDS-MAX



25	300	240	1	D-34207	7,19 €
25	400	330	1	D-34213	8,29 €
25	600	520	1	D-34229	12,99 €
50	400	300	1	D-34235	10,19 €
80	300	240	1	D-34241	16,99 €
50	400	300	1	D-78330	11,99 €

### Samoostríacie sekáče SDS-MAX



50	350	190	1	B-14015	24,99 €
	400	330	1	B-23064	17,99 €

### Sada sekáčov SDS-MAX



špic	400		5	D-35324-10	66,99 €
25	400		5		

## Sady sekáčov a vrtákov SDS-PLUS

**Sada sekáčov a vrtákov SDS-PLUS 10 ks**      **D-42385**      **63,99 €** (MOC s DPH)

vrták  $\varnothing$  6 x 110, 8 x 160, 10 x 210, 12 x 210 mm  
 sekáč špic 250 mm  
 sekáč plochý 20 x 250 mm



\*\*\*\*\*

**Sada sekáčov a vrtákov SDS-PLUS 10 ks**      **D-21191**      **55,99 €** (MOC s DPH)

vrták  $\varnothing$  5,5, 6 x 110 mm  
 7, 8 x 160 mm  
 10 x 210 mm  
 10, 16, 20 x 460 mm  
 sekáč špic 250 mm  
 sekáč plochý 20 x 250 mm



\*\*\*\*\*

**Sada sekáčov a vrtákov SDS-PLUS 13 ks**      **D-20111**      **48,99 €** (MOC s DPH)

vrták  $\varnothing$  5, 6, 7, 8 x 110 mm  
 6, 7, 8, 10, 12, 14, 16 x 160 mm  
 sekáč špic 250 mm  
 sekáč plochý 20 x 250 mm



\*\*\*\*\*

**Sada samoostriacích sekáčov SDS-PLUS 5 ks**      **E-13188**      **50,99 €** (MOC s DPH)

sekáč plochý 40 x 250 mm  
 sekáč plochý 20 x 250 mm 2 ks  
 sekáč špic 250 mm 2 ks



**Sady sekáčov a vrtákov SDS-PLUS 17 ks**      **D-42444**      **64,99 €** (MOC s DPH)

vrták  $\varnothing$  5, 6, 8, 10 x 110 mm  
 6, 8, 10, 12, 14 x 160 mm  
 8, 10 x 210 mm  
 12 x 260 mm  
 sekáč špic 140 mm  
 sekáč špic 250 mm  
 sekáč plochý 20 x 140 mm  
 sekáč plochý 20 x 250 mm  
 sekáč široký 40 x 250 mm



\*\*\*\*\*

**Sady sekáčov a vrtákov SDS-PLUS 17 ks**      **D-21200**      **62,99 €** (MOC s DPH)

vrták  $\varnothing$  5, 5,5, 6, 8, 10 x 110 mm  
 6, 7, 8, 10 x 160 mm  
 8, 10 x 210 mm  
 14 x 260 mm  
 sekáč špic 140 mm  
 sekáč špic 250 mm  
 sekáč plochý 20 x 140 mm  
 sekáč plochý 20 x 250 mm  
 sekáč široký 40 x 250 mm



\*\*\*\*\*

**Sada sekáčov SDS-PLUS 5 ks**      **D-16368**      **43,99 €** (MOC s DPH)

sekáč špic 2 x 250 mm  
 sekáč plochý 2 x 20 x 250 mm  
 sekáč široký 40 x 250 mm



\*\*\*\*\*

**Sada sekáčov/vrtákov SDS-plus 10 ks**      **D-71990**      **34,99 €** (MOC s DPH)

vrták  $\varnothing$  5; 6; 8; 10; 12 x 160 mm  
 10; 12; 16 x 210 mm  
 sekáč špic 250 mm  
 sekáč plochý 20 x 250 mm



## Sady sekáčov a vrtákov SDS-MAX

**Sada sekáčov SDS-MAX 6 ks**      **D-40565**      **93,99 €** (MOC s DPH)

sekáč špic 2 x 400 mm  
 sekáč plochý 2 x 25 x 400 mm  
 sekáč plochý 50 x 400 mm  
 sekáč plochý 80 x 300



\*\*\*\*\*

**Sada sekáčov SDS-MAX 5 ks**      **D-40618**      **79,99 €** (MOC s DPH)

sekáč špic 3 x 400 mm  
 sekáč plochý 2 x 25 x 400 mm



\*\*\*\*\*

**Sada sekáčov a vrtákov SDS-MAX 7 ks**      **D-42494**      **146,99 €** (MOC s DPH)

vrták  $\varnothing$  18, 20, 22, 25 x 540 mm  
 sekáč špic 400 mm  
 sekáč plochý 25 x 400 mm  
 sekáč plochý 50 x 400 mm



\*\*\*\*\*

**Sada sekáčov SDS-MAX 3 ks**      **D-40543**      **56,99 €** (MOC s DPH)

sekáč špic 400 mm  
 sekáč plochý 25 x 400 mm  
 sekáč plochý 50 x 400 mm



\*\*\*\*\*

# SEKANIE: SEKÁČE

ø mm	L1 mm	L2 mm	ks/bal	Obj. č.	MOC s DPH
------	-------	-------	--------	---------	-----------

## Pre kladivá s upnutím Bosch 19 mm

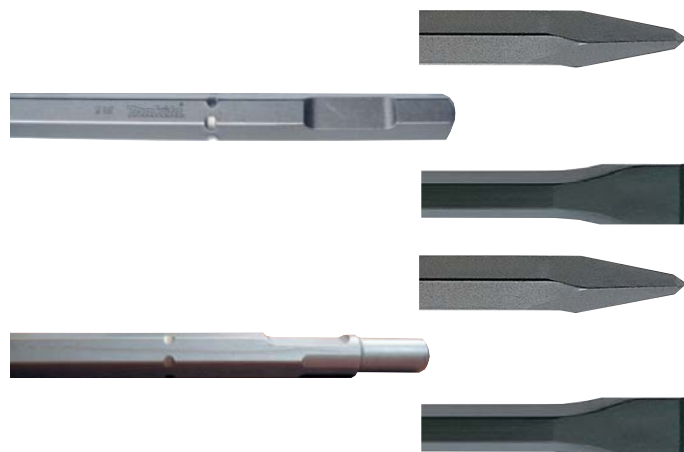

Sekáč špic pre Bosch kladivá 19 mm bez odsústruženého konca

400		1	P-05620	18,99 €
600		1	P-05614	24,99 €

Sekáč plochý pre Bosch kladivá 19 mm bez odsústruženého konca

25	400	1	P-05636	17,99 €
----	-----	---	---------	---------

Sekáč špic pre Bosch kladivá 19 mm s odsústruženým koncom

450		1	P-13138	19,99 €
-----	--	---	---------	---------

Sekáč plochý pre Bosch kladivá 19 mm s odsústruženým koncom

26	450	1	P-13150	19,99 €
----	-----	---	---------	---------

## Pre kladivá s upnutím Bosch 28 mm



Sekacie nástroje pre HM1304B, HM1801, HM1810 HM1307CB, HM1317CB, HM1802/HM1812

400		1	P-05692	37,99 €
-----	--	---	---------	---------

29	400	1	P-05723	37,99 €
80	400	1	P-05701	56,99 €
125	400	1	P-05717	77,99 €

## Sekáč špic uchytenie šesťhran ø 28,6mm



400		1	B-10372	32,99 €
350		1	D-65034	18,99 €
410		1	D-17631	23,99 €

## Upínacia stopka Makita



17 mm šesťhranná

280		1	P-13035	15,99 €
-----	--	---	---------	---------

17	280	1	P-13057	15,99 €
17	450	1	P-13063	19,99 €

## Upínacia stopka Makita



30 mm šesťhranná upínacia stopka pre HM1304, HM1400, HM1307C, HM1317C

400		1	B-10388	40,99 €
400		1	P-05549	39,99 €
700		1	P-05561	59,99 €
1000		1	P-05577	100,99 €

32	400	1	P-13487	39,99 €
32	400	1	P-13502	32,99 €
32	700	1	P-05583	61,99 €
115	400	1	P-13518	79,99 €
125	400	1	P-05555	101,99 €

200	ubíjadlo s upínacou stopkou	1	A-31485	122,99 €
-----	-----------------------------	---	---------	----------

	ochranná čiapočka proti prachu, sekáče a upínacie stopky	1	P-05446	4,19 €
	ochranná čiapočka proti prachu	1	423154-0	0,59 €

	prepravný vozík (HM1801/1810/1802/1812)	1	D-54972	193,99 €
--	---	---	---------	----------

# SEKANIE: ŠPECIÁLNE PRÍSLUŠENSTVO PRE VŔTACIE A SEKACIE KLADIVÁ

Model	Obj. č.	MOC s DPH
-------	---------	-----------



Rukoväte		
HR3540C, HR3541FC, HR4001C, HR4002, HR4010C, HR4011C, HR4501C, HR4510C, HR4511C	135209-6	21,99 €
DHR400, HR005G, HR4003C, HR4013C	123138-5	34,93 €
HM001G, HM0870C, HM0871C	135332-7	15,41 €
HP1621, HP1630, HP1631, HP2051, HP2071, HR2440, HR2450, HR2470	135302-6	2,99 €
HR3200C, HR3210FCT	135197-7	23,99 €



Mazací tuk pre prevodovky a nástroje		
mazací tuk pre prevodovky 30 g	181490-7	3,39 €
mazací tuk pre prevodovky 500 g	042040-2A	28,99 €
mazací tuk pre prevodovky 2,5 kg	042025-8A	83,99 €
mazací tuk na nástroje 100 ml	198993-4	8,79 €



Adaptér		
adaptér skľučovadla SDS-PLUS / 1/2" – 20 UNF	122573-4	10,29 €
adaptér + skľučovadlo SDS-PLUS	122574-2	35,99 €
Bitový adaptér 1/4"	P-21646	9,09 €



Protiprachový kryt pre stopku vŕtáka a sekáča		
protiprachový kryt pre stopku vŕtáka a sekáča ø 10 – 18 mm	421664-1	2,09 €
ø 6 – 14 mm	421342-3	1,89 €



Odsávací adaptér		
HR140D, HR166D, DHR164, DHR165, DHR171, DHR182, DHR202, DHR262, DHR263, DHR264, HR1840, HR2020, HR2022, HR2230, HR2460, HR2460F, HR2470, HR2470F, HR2470FT, HR2470T, HR2475, HR2800, HR2810, HR2810T, HR2811F, HR2811FT,	193472-7	46,99 €



vyfukovací balónik po vŕtaní	765009-6	2,09 €
------------------------------	----------	--------

Model	Obj. č.	MOC s DPH
-------	---------	-----------



Rukoväte		
HR4001C, HR4002, HR4010C, HR4011C, HR4501C, HR4510C, HR4511C, HM1101C, HM1111C	134890-0	41,99 €
HR006G, HR5202C, HR5212C, HM1214C	135283-4	44,99 €
HM002G, HM1202C, HM1203C, HM1205C, HM1213C, HM1242C	135269-8	23,91 €
HR5001C	134945-1	36,99 €



Doraz hĺbkový		
HP1630, HP1631, HP1640/F, HP1641/F, HP2050/F, HP2051/F, HP2070/F, HP2071/F	324219-0	0,71 €



Rýchlovýmenné skľučovadlo (vŕtanie)		
HR2320T, HR2470T, HR2470FT, HR2630T, HR2631FT, HR2651T, HR2653T, HR2810T, HR2811FT, HR2450T, DHR243, DHR264	194079-2	60,99 €
DHR281, DHR283, HR002G, HR004G	199139-5	44,99 €



Rýchlovýmenné skľučovadlo (SDS-PLUS)		
HR2320T, HR2470T, HR2470FT, HR2630T, HR2631FT, HR2651T, HR2653T, HR2810T, HR2811FT, HR2450T, DHR243, DHR264	194080-7	38,99 €
HR3210FCT	194578-4	73,99 €
DHR281, DHR283, HR002G, HR004G	199138-7	16,35 €



Odsávací adaptér		
DHR242, HR2650, HR2651, HR2652, HR2653, DHR281, DHR283, HR001G, HR003G, HR3012FC, HR2661, HR2663	195173-3	6,79 €
DHR243, HR2651T, HR2653T, HR2300T, HR2320T, HR2631FT, HR2630T, HR002G, HR004G	195179-1	8,39 €

Manžeta		
DX05, DX06, DX07, DX08, DX09, DX12, DX14, HR2652, HR2653, HR2653T, HR2663	424474-5	0,69 €

## PRÍSLUŠENSTVO K VŔTAČKÁM

klúč	popis	uchytenie	popis	Obj. č.	MOC s DPH	
<b>Skľučovadlá s ozubeným vencom bez klúča</b> <span style="float: right;">*****</span>						
	763418-3*	0,5 – 6,5	3/8"	6013BR, 6305, 6501/X	192887-5	14,99 €
	763448-4*	1,5 – 13	1/2"	HP2050, HP2070, DP4010	193822-6	35,99 €
	763418-3*	0,5 – 6,5	3/8"	DP2010	763077-3	6,99 €
	763415-9	0 – 10	3/8"	BDA340, BDA350, DA3010F	763174-5	35,99 €
		1,5 – 13	1/2"	6013B, 6300-4, DP4700,	766016-2	10,99 €
	763251-3*	2,0 – 13		DDA460, DGA460, DA001G, DG001G	763250-5	41,99 €

<b>Klúč ku skľučovadlám</b> <span style="float: right;">*****</span>						
		10		DA3000, DA3000R	763414-1	2,99 €
		10		DA3010	763415-9	2,29 €
		10		6412	763418-3	1,19 €
		13		6305, 6013B/BR, 6300-4, DA4000LR, DA6301, UT1305, UT2204	763432-9	2,29 €
		13		DP4010, HP1620, HP1630, HP1640, HP2050, HP2070	763448-4	1,59 €
		10		6305, 6501/X, 6510LVR	P-04341	1,09 €
		13		DDA460, DGA460, DA001G, DG001G	763251-3	4,39 €
		13			A-86228	4,69 €

<b>Rýchlopínacie skľučovadlá</b> <span style="float: right;">*****</span>						
		0,8 – 10	3/8"	6408, DA3011F	192016-0	24,99 €
		1,5 – 13	1/2"	6013B/BR, 6300-4, DP4001, DP4003, DP4700, HP1621, HP2051, HP2071	192685-7	39,99 €
		1,5 – 13	1/2"		193064-2	46,99 €
		1,5 – 13	1/2"	DP4011, HP2051, HP2071	194254-0	56,99 €
		1,5 – 13	1/2"	6390D, 8390D, HP1621, HP1631, HP1641	196193-0	24,99 €
		1,5 – 13	1/2"	6391D, DDF453, DHP453	196306-3	14,99 €
		1,0 – 10	1/2"	6260D, 6270D, 6280D	196307-1	16,99 €
		0,8 – 10	1/2"	8271D, 8281D, DHP343	763229-6	6,79 €
		1,5 – 13	1/2"	MT065	763182-6	16,99 €
		1,5 – 10	1/2"	6260D, 6270D, 6280D, 6207D, 8270D, 8280D	763187-6	16,99 €
		1,5 – 13	1/2"	6319D, 6339D, 6349D, 8414D, 8434D, 8444D	763188-4	35,99 €
		1,5 – 13	1/2"	DDF441, DDF451, DHP441, DHP451, DDF444, DDF454, DHP444, DHP454	763196-5	35,99 €
		1,5 – 10	3/8"	BDA341, BDA351, DF330D	763228-8	14,99 €
		0,8 – 10	1/2"	HP330	763229-6	6,79 €
		0,8 – 10	1/2"	HP332, DF332, HP333, DF333	763238-5	9,39 €
		1,5 – 13	1/2"	DDF483, DHP483	763241-6	22,99 €
		0,8 – 10		DDF343, DF347	763243-2	6,09 €
		1,5 – 13	1/2" – 20 UNF	DDF446, DDF456, DDF459, DDF480, DDF482, DDF484, DDF485	763252-1	25,99 €
		0,8 – 10		MT080, DF0300	766012-0	16,09 €
		1,5 – 13	1/2" – 20 UNF	DDF446, DDF456, DDF459, DDF480, DDF482, DDF484, DDF485	766027-7	16,99 €
				držiak klúča ku skľučovadlu	410102-8	0,29 €

# PRÍSLUŠENSTVO K VŔTAČKÁM

## Príslušenstvo pre magnetickú vŕtačku HB350 / 500



ø mm	L1 mm	L2 mm	ks/bal	Obj. č.	MOC s DPH
12	30		1	12S	21,99 €
13	30		1	13S	21,99 €
14	30		1	14S	21,99 €
15	30		1	15S	21,99 €
16	30		1	16S	23,99 €
17	30		1	17S	23,99 €
18	30		1	18S	25,99 €
19	30		1	19S	26,99 €
20	30		1	20S	28,99 €
22	30		1	22S	30,99 €
24	30		1	24S	32,99 €
26	30		1	26S	37,99 €
28	30		1	28S	43,99 €
30	30		1	30S	45,99 €
32	30		1	32S	47,99 €
36	30		1	36S	56,99 €
38	30		1	38S	62,99 €
40	30		1	40S	72,99 €
46	30		1	46S	86,99 €
50	30		1	50S	106,99 €
strediaci kolík pre vŕtáky > 14			1	PILOTS	7,49 €
strediaci kolík pre vŕtáky < 17			1	PILOTU1A	6,59 €
strediaci kolík pre vŕtáky > 17			1	PILOTU1B	8,29 €
skľučovadlo pre HB500			1	BD062	355,37 €

priemery od 36 do 50 len pre model HB500

## Vykružovacie korunky do železa a nehrdzavejúcej ocele

ø mm	max. hrúbka materiálu (mm)	ks/bal	obj. č.	MOC s DPH
16	4	1	B-00898	61,99 €
20	4	1	B-00913	61,99 €
38	4	1	B-01018	95,99 €



## Háčky pre aku vŕtacie skrutkovače

model	obj. č.	MOC s DPH
BDF444, DDF446, BDF454, DDF456, DDF458, BDF444, DDF446, BDF454, DDF456, DDF458, DDF459, DDF480, DDF481, BHP444, DHP446, BHP454, DHP456, DHP458, DHP459, DHP480, DHP481, DTW250, DTW251, DTW280	346317-0	2,49 €
DFR540RFE, DFR550RFE, DFR750RFE	281217-6	3,50 €
BTW450RFE	345736-7	2,62 €



DDF441, DDF444, DDF448, DDF451, DDF454, DDF458, DDF481, DDF486, DF001G, DHP441, DHP444, DHP448, DHP451, DHP454, DHP458, DHP481, DHP486, HP001G	452947-8	0,36 €
--	----------	--------



## Príslušenstvo pre miešadlá



Kruhové miešadlo  
vyrovňavacie hmoty,  
bitúmenové vrstvy, farby,  
základný adhézný náter,  
náterové tmely,  
zalievacie hmoty

Špirálové miešadlo stavebné  
lepidlá, mazaninu, hotovú  
maltu, lepidlo na kachličky,  
škárovaciu hmotu, maltu na  
lepenie obkladov, omietky,  
náterové tmely, tepelné  
izolačné omietky

Zmiešané miešadlo  
vyrovňavacie hmoty,  
stavebné lepidlá, betón,  
mazaninu, hotovú maltu,  
maltu na lepenie obkladov,  
nivelačné hmoty, všetky  
druhy malty



Špirálové miešadlo „negatív“  
M14 disperzie, farby,  
vápennosadrovú maltu,  
tepelnú izolačnú omietku.  
Zmiešaný účinok dole



Tanierová metla farba,  
nivelačné potery



ø mm	popis	L mm	upínanie	ks/bal	Obj. č.	MOC s DPH
80	kruhovú metla 10 – 15 kg	400	6 hran	1	P-02331	12,99 €
120	kruhovú metla 15 – 30 kg	590	M14	1	P-22012	25,99 €
120	kruhovú metla 10 – 15 kg	600	6 hran 3/8"		D-73536	10,99 €
120	kruhovú metla 15 – 30 kg	600	6 hran 3/8"		D-73542	10,19 €
90	špirálovú metla 7 – 10 kg	400	6 hran	1	P-02347	13,99 €
135	špirálovú metla 15 – 30 kg	590	M14	1	P-22040	32,99 €
100	zmiešanú metla 5 – 15 kg	590	6 hran	1	P-02353	32,99 €
120	špirálovú metla „negatív“ 15 – 25 kg	590	M14	1	P-22056	43,99 €
120	špirálovú metla 15 – 25 kg	600	M14	1	D-73514	21,99 €
120	špirálovú metla 15 – 25 kg	600	M14	1	D-73520	19,99 €
100	špirálovú metla 30 KG	600	M14	1	P-76766	25,99 €
165	tanierovú metla		M12	1	165757-1	7,09 €
130	tanierovú metla		M12	1	A-43670	15,99 €
	oska miešadla	560	M12	1	168349-5	27,99 €
	adaptér miešadla		1/2" – M12	1	323962-8	4,17 €
	adaptér miešadla		1/2" – M14	1	P-22062	9,99 €
	adaptér miešadla		5/8" – M14	1	P-02325	11,99 €
	ochranný kryt		DUT130	1	458814-5	9,39 €
	bočná rukoväť		DUT130	1	140G50-6	cena na vyžiadanie

## PRÍSLUŠENSTVO K VŔTAČKÁM

ø mm	veľkosť (mm)	Obj. č.	MOC s DPH
------	--------------	---------	-----------

### Diamantové vŕtacie korunky na vŕtanie nasucho – upínanie M16



Vhodné pre DBM080 a DBM130.



diamantová vŕtacia korunka	76 × 150	P-42020	228,99 €
	82 × 400	P-42086	190,99 €
	112 × 400	P-42092	308,99 €

vystreďovacia tyč	60	P-41888	34,99 €
	112	P-41969	10,99 €
	132	P-41981	5,29 €

Do vypredania skladových zásob.

#### Postup montáže vŕtacích korúnok

Kotúč pre  
vystreďovaciu  
tyč

Vystreďovacia  
tyč

Diamantová vŕtacia  
korunka

Odsávací adaptér

DBM130



ø mm	dĺžka mm	ks/bal	Obj. č.	MOC s DPH
------	----------	--------	---------	-----------

### Diamantové korunky vŕtanie na sucho DB6 DIAMAK



Vhodné na rezanie:  
Žula, mramor, vápenc, bridlica,  
tvrdé tehly a iné husté  
a neabrazívne materiály.



48	150	1	P-64107	cena na vyžiadanie
52	150	1	P-64113	48,99 €
68	150	1	P-64129-68	52,99 €
78	150	1	P-64135	55,99 €

popis	Obj. č.	MOC s DPH
-------	---------	-----------

adaptér 1/2" na HEX	P-34562	16,99 €
adaptér 1/2" na SDS-PLUS	P-30031	21,99 €
vyrážací klin	P-34752	4,29 €
vodiaca tyč pre korunky	P-34746	8,99 €



# PRÍSLUŠENSTVO K DIAMANTOVÝM VŔTAČKÁM

	dĺžka mm	Obj. č.	MOC s DPH
--	-------------	---------	-----------

## Šesťhranná predĺžovacia tyč z ocele \*\*\*\*\*

5/4" UNC na 5/4" UNC	200	P-41610	41,99 €
	300	P-41626	65,99 €
	400	P-41632	67,99 €
	500	P-41648	97,99 €



## Prírubby pre vrtáky so „závitom“ \*\*\*\*\*

	kotviaca (zatĺkacia) hmoždinka (M12)	P-41741	4,99 €
--	--------------------------------------	---------	--------



## Sada upevňovacích kotiev \*\*\*\*\*

	sada kotiev	P-40098	40,99 €
--	-------------	---------	---------



## Adaptéry \*\*\*\*\*

P-41676	P-41682	vonkajší 5/4" UNC na vonkajší 1/2" BSP	P-41676	53,99 €
		vnútorný 1/2" BSP na vnútorný 5/4" UNC	P-41682	53,99 €
		vnútorný 1/2" BSP na vnútorný 1/2" BSP	P-41698	40,99 €
		hl na vonkajší 1/2" BSP	P-41707	52,99 €
		vnútorný M18 na vonkajší 5/4" / vnútorný 1/2"	P-42151	38,99 €
		M18 na M16	P-45082	42,99 €



## Stojan jadrovej vŕtačky DBM230/131 \*\*\*\*\*

	Stojan jadrovej vŕtačky DBM131	P-40082	805,99 €
--	--------------------------------	---------	----------



Akumulátory  
 Odkladacie systémy  
 Vŕtanie  
 Skrutkovanie  
 Brúsky  
 Pílenie  
 Frézovanie  
 Brúsenie  
 Klince / spony  
 Špeciálne stroje  
 Vysávanie  
 Fény/lampy  
 Záhrada  
 Ručné náradie  
 Ostatné

# Príslušenstvo

## Skrutkovanie, bity, držiaky, nástrčné kľúče

### 1. C-form



### 2. E-form



### 3. obojstranné

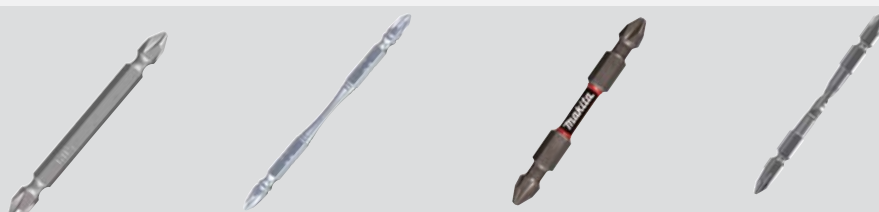

### 4. držiaky bitov



### 5. nástrčné kľúče



### 6. sady bitov



### 7. adaptéry



### 8. nástrčné kľúče pre rázové uťahovák



### 9. iné produkty

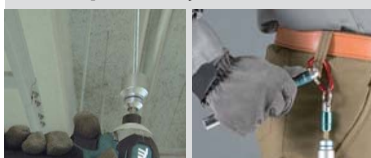

**Impact**

# PREMIER

*Double Torsion  
for High Durability.*



*New Steel  
is Used.  
Supports High Torque.*

*High Precision  
Screw Fitting.*

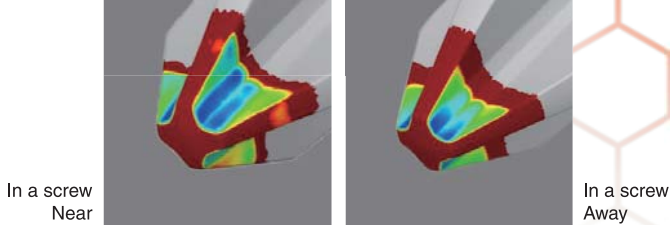
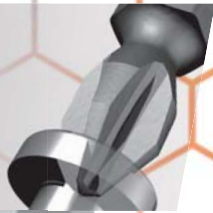

**Impact  
PREMIER**

**STANDARD**

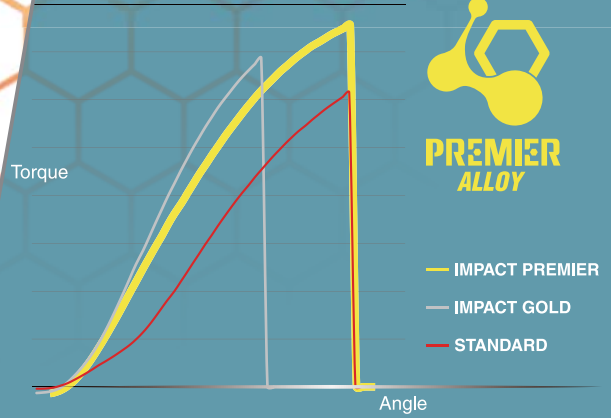

**NEW  
INNOVATION**



### Premier



er



"

#### Sada bitov 31 ks

E-13552

41,99 € (MOC s DPH)

PH1; 5 x PH2; 2 x PH3;  
PZ1; 5 x PZ2; 2 x PZ3;  
T10; T15; 3 x T20; 2 x T25;  
2 x T30; H4; H5; H6; SL4; SL6;  
magnetický držiak bitov 50 mm



typ	dĺžka mm	ks/bal	Obj. č.	MOC s DPH
PH 1	25	2	E-03121	3,59 €
PH 2	25	2	E-03137	3,79 €
PH 2	25	15	E-03246	19,99 €
PH 2R	25	2	E-03143	3,89 €
PH 3	25	2	E-03159	3,89 €
PZ 1	25	2	E-03165	3,49 €
PZ 2	25	2	E-03171	3,29 €
PZ 2	25	15	E-03252	17,99 €
PZ 3	25	2	E-03187	3,69 €
T 10	25	2	E-03193	3,69 €
T 15	25	2	E-03202	3,39 €
T 20	25	2	E-03218	3,29 €
T 25	25	2	E-03224	3,19 €
T 30	25	2	E-03230	3,39 €
T 40	25	2	E-20242	3,59 €

PH 1	50	2	E-03268	5,19 €
PH 2	50	2	E-03274	4,59 €
PH 2	50	10	E-03377	19,99 €
PH 3	50	2	E-03280	5,29 €
PZ 1	50	2	E-03296	5,09 €
PZ 2	50	2	E-03305	5,09 €
PZ 2	50	10	E-03383	19,99 €
PZ 3	50	2	E-03311	5,19 €
T 10	50	2	E-03327	5,09 €
T 15	50	2	E-03333	5,39 €
T 20	50	2	E-03349	4,69 €
T 25	50	2	E-03355	4,59 €
T 30	50	2	E-03361	4,79 €
T 40	50	2	E-12027	5,29 €

torzný držiak bitu magnetický	68	1	E-20258	8,09 €
torzný držiak bitu magnetický	150	1	E-20264	10,19 €

torzný držiak bitu ultra magnetický	79	1	E-20270	9,69 €
-------------------------------------	----	---	---------	--------

nástrčný kľúč 6	65	1	E-03458	4,69 €
nástrčný kľúč 8	65	1	E-03464	5,39 €
nástrčný kľúč 10	65	1	E-03470	5,29 €
nástrčný kľúč 13	65	1	E-03486	7,29 €

nástrčný kľúč kĺbový 13	80	1	E-03492	10,99 €
nástrčný kľúč kĺbový 17	80	1	E-03517	10,99 €
nástrčný kľúč kĺbový 19	80	1	E-03523	10,29 €

adaptér 1/4" – 1/2"	50	1	E-03436	6,99 €
adaptér 1/4" – 3/8"	50	1	E-03420	7,39 €

PH1, PH2, PH3, PZ1, PZ2, PZ3, T15, T20, T25, T30 x 25 mm, Magnetický držiak bitov 50 mm	1	E-03567	23,99 €
PH2, PZ1, PZ2, PZ3, T15, T20, T25, T30, SL4, SL6 x 25 mm, Magnetický držiak bitov 50 mm	1	E-03573	23,99 €

magnetický držiak	1	E-03442	4,69 €
-------------------	---	---------	--------

typ	dĺžka mm	ks/bal	Obj. č.	MOC s DPH
-----	----------	--------	---------	-----------

## Impact black



PH 1	25	2	B-63600	1,69 €
PH 2	25	2	B-63616	1,69 €
PH 3	25	2	B-63622	1,79 €
PZ 1	25	2	B-63638	1,69 €
PZ 2	25	2	B-63644	1,69 €
PZ 3	25	2	B-63650	1,79 €
T 15	25	2	B-63666	1,79 €
T 20	25	2	B-63672	1,69 €
T 25	25	2	B-63688	1,69 €
T 30	25	2	B-63694	1,69 €
T 40	25	2	B-63703	1,79 €

torzný držiak bitu magnetický	60	1	B-66793	3,39 €
torzný držiak bitov magnetický	80	1	B-66818	3,89 €
torzný držiak bitov magnetický s poistkou	60	1	B-66802	4,59 €
adaptér 1/4" – 1/2"	50	1	B-66874	2,99 €
adaptér 1/4" – 3/8"	50	1	B-66868	2,59 €

PH 1	50	2	B-63719	2,49 €
PH 2	50	2	B-63725	2,49 €
PH 3	50	2	B-63731	2,59 €
PZ 1	50	2	B-63747	2,49 €
PZ 2	50	2	B-63753	2,49 €
PZ 3	50	2	B-63769	2,59 €
T 15	50	2	B-63775	2,59 €
T 20	50	2	B-63781	2,49 €
T 25	50	2	B-63797	2,49 €
T 30	50	2	B-63806	2,49 €
T 40	50	2	B-63812	2,49 €
PZ2	50	10	E-12413	11,99 €
T20	50	10	E-12429	11,99 €
T25	50	10	E-12435	11,99 €
T30	50	10	E-12675	11,99 €
T40	50	10	E-12681	11,99 €

nástrčný kľúč 6	50	1	B-66824	2,39 €
nástrčný kľúč 8	50	1	B-66830	2,19 €
nástrčný kľúč 10	50	1	B-66846	2,29 €
nástrčný kľúč 13	50	1	B-66852	2,69 €

### IMPACT BLACK SADA BITOV 8 KS E-11994 8,69 € (MOC s DPH)

PH1; 2 X PH2; PH3;  
PZ1; PZ2; PZ3,  
magnetický držiak bitu 60 mm



### IMPACT BLACK SADA BITOV 10 KS E-12011 15,99 € (MOC s DPH)

PH1; PH2; PH3.  
PZ1; PZ2; PZ3;  
T15; T20; T25; T30



### Sada nástrčných kľúčov 6 ks E-15768 19,99 € (MOC s DPH)

Nástrčné magnetické kľúče  
6; 7; 8; 10; 12; 13 x 50 mm



### IMPACT BLACK SADA BITOV 35 ks B-66880 42,99 € (MOC s DPH)

PH1, 3 x PH2, PH3, PZ1, 3 x PZ2,  
PZ3 x 25 mm  
T15, 2 x T20, 2 x T25, T30 x 25 mm  
PH1, 2 x PH2, PH3, PZ1, 2 x PZ2,  
PZ3 x 50 mm  
T15, T20, 2 x T25, T30 x 50 mm  
SLO 8 x 5,5 x 50 mm  
magnetický držiak bitov 60 mm  
6/8/10/13 x 50 mm „orech“



### IMPACT BLACK sada nástrčných kľúčov 9 KS E-16639 26,99 € (MOC s DPH)

upínanie 3/8"  
8; 10; 12; 13; 14; 15; 17; 18;  
adaptér 1/4" šesťhran na 3/8"



### IMPACT BLACK sada nástrčných kľúčov 9 KS E-16564 64,99 € (MOC s DPH)

upínanie 1/2"  
8; 10; 13; 16; 17; 18; 19; 21; 24;



### Sada bitov 10 ks E-12005 14,99 € (MOC s DPH)

Bity 25 mm: PH1; PH2; PH3;  
PZ1; PZ2; PZ3; T15; T20; T30  
magnetický držiak bitov 60 mm



# SKRUTKOVÁČE

typ	dĺžka mm	ks/bal	Obj. č.	MOC s DPH
-----	----------	--------	---------	-----------

## Skrutkovacie hroty Krížové „PH“



	ŠTANDARD	PH				
		typ	dĺžka mm	ks/bal	Obj. č.	MOC s DPH
PROFI	PH1	25	5	P-47933	3,69 €	
	PH1	50	5	P-48402	4,69 €	
	PH2	25	5	P-47949	3,59 €	
	PH2	50	5	P-48418	4,79 €	
	PH3	25	5	P-47955	3,79 €	
	PH3	50	5	P-48424	4,39 €	
	PH1	25	5	P-47874	3,79 €	
	PH1	50	5	P-48234	12,99 €	
	PH1	89	5	P-48240	17,99 €	
	PH2	25	5	P-47880	3,89 €	
	PH2	25	50	P-47880-50	21,99 €	
	PH2	25	100	P-47880-100	38,99 €	
PH2	50	5	P-48256	12,99 €		
PH2	89	5	P-48262	17,99 €		
PH2	127	5	P-48278	19,99 €		
PH2	141	5	P-48315	21,99 €		
PH3	25	5	P-47896	3,79 €		
TITAN	PH2	25	5	P-48000	7,39 €	
TITAN	PH2	50	5	P-48474	8,89 €	

## Skrutkovacie hroty Krížové „PZ“



	ŠTANDARD	PZ				
		typ	dĺžka mm	ks/bal	Obj. č.	MOC s DPH
PROFI	PZ1	25	5	P-47961	3,79 €	
	PZ1	50	5	P-48430	4,59 €	
	PZ2	25	5	P-47977	3,69 €	
	PZ2	25	50	P-47977-50	16,99 €	
	PZ2	25	100	P-47977-100	32,99 €	
	PZ2	50	5	P-48446	4,69 €	
	PZ3	25	5	P-47983	3,79 €	
	PZ3	50	5	P-48452	4,39 €	
	PZ1	25	5	P-47905	3,89 €	
	PZ1	50	5	P-48321	11,99 €	
	PZ1	89	5	P-48337	17,99 €	
	PZ2	25	5	P-47911	3,89 €	
PZ2	25	50	P-47911-50	21,99 €		
PZ2	25	100	P-47911-100	41,99 €		
PZ2	50	5	P-48343	12,99 €		
PZ2	89	5	P-48359	18,99 €		
PZ2	127	5	P-48365	19,99 €		
PZ3	25	5	P-47927	3,89 €		
PZ3	50	5	P-48371	12,99 €		
TITAN	PZ1	25	5	P-48022	7,39 €	
TITAN	PZ2	25	5	P-48038	7,39 €	
TITAN	PZ2	50	5	P-48505	9,09 €	
TITAN	PZ3	25	5	P-48044	7,59 €	
TITAN	PZ3	50	5	P-48511	8,89 €	

typ	dĺžka mm	ks/bal	Obj. č.	MOC s DPH
-----	----------	--------	---------	-----------

## Skrutkovacie hroty TORX



	PROFI	TORX				
		typ	dĺžka mm	ks/bal	Obj. č.	MOC s DPH
PROFI	T8	25	5	P-48050	5,29 €	
	T8	50	5	P-48527	6,39 €	
	T10	25	5	P-48072	5,79 €	
	T10	50	5	P-48549	6,19 €	
	T15	25	5	P-48088	5,69 €	
	T15	50	5	P-48555	6,19 €	
	T20	25	5	P-48094	5,79 €	
	T20	50	5	P-48561	6,19 €	
	T25	25	5	P-48103	5,79 €	
	T25	50	5	P-48577	6,19 €	
	T27	25	5	P-48119	5,69 €	
	T27	50	5	P-48583	6,19 €	
	T30	25	5	P-48125	5,79 €	
	T30	50	5	P-48599	6,19 €	
	T40	25	5	P-48131	5,79 €	
	T40	50	5	P-48608	6,19 €	
TITAN	T10	25	5	P-48169	8,69 €	
	T10	50	5	P-48636	9,99 €	
	T15	50	5	P-48642	8,99 €	
	T20	25	5	P-48181	9,39 €	
	T20	50	5	P-48658	9,69 €	
	T25	25	5	P-48197	9,39 €	
	T25	50	5	P-48664	9,09 €	
	T30	25	5	P-48212	9,29 €	
T40	25	5	P-48228	8,99 €		

## Nástrčkový bit



	PROFI	Hex				
		dĺžka mm	ks/bal	Obj. č.	MOC s DPH	
PROFI	5,5	50	1	P-48723	5,59 €	
	6	50	1	P-48739	5,99 €	
	7	50	1	P-48745	6,49 €	
	8	50	1	P-48751	6,99 €	
	9	50	1	P-48767	6,49 €	
	10	50	1	P-48773	7,49 €	
	10	65	1	P-48789	8,49 €	
	13	50	1	P-48795	8,39 €	
	13	65	1	P-48804	9,19 €	
	17	50	1	P-48810	11,99 €	
	17	65	1	P-48826	11,99 €	

## Nástrčkový bit s magnetom



	PROFI	Hex				
		dĺžka mm	ks/bal	Obj. č.	MOC s DPH	
PROFI	7	50	1	P-48854	11,99 €	
	8	50	1	P-48860	11,99 €	
	10	50	1	P-48876	11,99 €	
	10	65	1	P-48882	12,99 €	
	13	50	1	P-48898	12,99 €	
	6, 8, 10, 12, 13	50	1	B-39154	7,19 €	



# SKRUTKOVÁČE

typ	dĺžka mm	ks/bal	Obj. č.	MOC s DPH
<b>Magnetický nadstavec</b> *****				
magnetický nadstavec	60	1	P-49018	7,19 €
magnetický nadstavec	60	1	B-52445	3,09 €
magnetický nadstavec	75	1	P-49024	8,89 €
magnetický nadstavec	80	1	B-48751	3,89 €
magnetický nadstavec	150	1	B-57750	6,09 €
magnetický nadstavec	300	1	B-57766	7,59 €

<b>Obojstranné magnetické bity</b> *****				
PZ2	65	100	D-34914	50,99 €
PH2	65	100	D-31669	60,99 €

<b>Ohybný hriadeľ so skrutkovacou čepelou</b> *****				
	200	1	B-29072	6,39 €
	300	1	B-29094	8,29 €

typ	dĺžka mm	ks/bal	Obj. č.	MOC s DPH
<b>Adaptér</b> *****				
adaptér 1/4" – 1/2"	50	1	B-54673	2,69 €

<b>Nadstavec na sádkartónárske skrutky PH2</b> *****				
upínanie 1/4"	30	1	D-61690	1,29 €

<b>Nadstavec na zakrúcanie závitových tyčí s upínaním 1/4"</b> *****				
M8	66	1	B-42977	18,99 €

<b>Obojstranné magnetické bity</b> *****				
PH2	85	3	B-12326	10,49 €
PZ2	85	3	B-12790	9,69 €

**Sada bitov 61 ks** P-70144 **59,99 €** (MOC s DPH)

2x5,5 / 2x6,5; 6xPH1; 12xPH2; 4xPH3; 2xPZ0; 6xPZ1; 12xPZ2; 2xPZ3; 2xT10, T15, T20; 2xT25, T30, T40;



\*\*\*\*\*

**Sada bitov 26 ks** B-48773 **12,99 €** (MOC s DPH)

5 x PH2 25 mm; 5 x PZ2 25 mm; 5 x T20 25 mm; 5 x T25 25 mm; 5 x T30 25 mm; x 80 mm magnetický držiak bitov



\*\*\*\*\*

**Sada bitov 11 ks** P-49030 **12,99 €** (MOC s DPH)

1ks SL3,5; 1ks SL5,5; 1ks PH1; 2ks PH2; 1ks PH3; 1ks PZ1; 2ks PZ2; 1ks PZ3; 1ks magnetický nadstavec



\*\*\*\*\*

**Sada bitov 31 ks** P-73374 **19,99 €** (MOC s DPH)

2ks PH1; 4ks PH2; 2ks PH3; 2ks PZ1; 4ks PZ2; 2ks PZ3; 1ks T8; 2ks T10; 2ks T15; 2ks T20; 3ks T25; 1ks T27; 2ks T30; 1ks T40; 1ks nadstavec



\*\*\*\*\*

**Sada bitov 11 ks** P-49046 **19,99 €** (MOC s DPH)

1ks SL3,5; 1ks SL5,5; 1ks PH1; 2ks PH2; 1ks PH3; 1ks PZ1; 2ks PZ2; 1ks PZ3; 1ks magnetický nadstavec



\*\*\*\*\*

**Sada bitov 21 ks** B-68323 **17,99 €** (MOC s DPH)

PH1; 2ks PH2; PH3 x 50 mm; PZ1; 2ks PZ2; PZ3; T10; T15; T20; x 50mm; T10; T15; T20; 2ks T25; 2ks T30; x 50 mm; H3; H4; H5; H6 x 50 mm; SL5,5; SL6,5 x 50 mm



\*\*\*\*\*

**Sada bitov 30 ks** E-15774 **23,99 €** (MOC s DPH)

Bity 25 mm: PZ0; PZ1; PZ2; PZ3; PH0; PH1; PH2; PH3; SL3; SL4; SL5; SL6; H3; H4; H5; H6; Bity 50 mm: SL3; SL5; PZ1; PZ2 x 2; PH1; PH2; Bity 75 mm: SL3; SL4; PZ1; PZ2; PH1; PH2; 1 x magnetický držiak bitov 60 mm



Akumulátory  
Odkládačie systémy  
Vŕtanie  
Skrutkovanie  
Brúsky  
Pílenie  
Frézovanie  
Brúsenie  
Klince / spony  
Špeciálne stroje  
Vysávanie  
Fény/lampy  
Záhada  
Ručné náradie  
Ostatné

# SKRUTKOVAČE

<p><b>Sada bitov 31 ks, balenie 12 ks</b></p> <p>D-30667-12 147,99 € (MOC s DPH)</p> <p>plochý 4 (1 ks); plochý 5,5 (1 ks); plochý 6,5 (1 ks); PH1 (2 ks); PH2 (4 ks); PH3 (1 ks); PZ1 (2 ks); PZ2 (5 ks); PZ3(1 ks); T10 (2 ks); T15 (2 ks); T20 (2 ks); T25 (3 ks); T30 (2 ks); T40 (1 ks)</p> <p>***</p>		<p><b>Sada bitov 11 ks, balenie 12 ks</b></p> <p>D-30651-12 126,99 € (MOC s DPH)</p> <p>PH1, PH2, PH3 × 25 mm PZ1, PZ2, PZ3, × 25 mm T15, T20, T25, T30 × 25 mm magnetický nadstavec 50 MM</p> <p>***</p>	
<p><b>Sada bitov 12 ks, balenie 12 ks</b></p> <p>D-31083-12 108,99 € (MOC s DPH)</p> <p>plochý 4 (1 ks); plochý 5,5 (1 ks); plochý 6,5 (1 ks); PH1 (2 ks); PH2 (4 ks); PH3 (1 ks); PZ1 (2 ks); PZ2 (5 ks); PZ3(1 ks); T10 (2 ks); T15 (2 ks); T20 (2 ks); T25 (3 ks); T30 (2 ks); T40 (1 ks)</p> <p>***</p>		<p><b>Sada bitov 31 ks, balenie 12 ks</b></p> <p>E-00022 157,99 € (MOC s DPH)</p> <p>PH0, PH1, 4 × PH2, PH3 × 25 mm PZ0, PZ1, 4 × PZ2, PZ3 × 25 mm T10, T15, T20, T27, T30, T40 × 25 mm H3, H4, H5, H6 × 25 mm SL4,5, SL5,5, SL6,5 × 25 mm</p> <p>***</p>	
<p><b>Sada bitov 31 ks, balenie 12 ks</b></p> <p>E-03090 266,99 € (MOC s DPH)</p> <p>2 × PH1, 5 × PH2, 2 × PH3 × 25 mm 2 × PZ1, 5 × PZ2, 2 × PZ3 × 25 mm 3 × T15, 3 × T20, 3 × T25, 3 × T30 × 25 mm držiak bitov magnetický 60 mm</p> <p>*****</p>		<p><b>Sada bitov a vrtákov 31 ks</b></p> <p>B-49389 35,99 € (MOC s DPH)</p> <p>vrtáky do železa ø 2; 2 × 3; 3,3; 4; 4,2; 5; vrtáky do tehly a muriva ø 4; 5; 6; 7; 8; vrtáky do dreva ø 3; 4; 5; 6; 7; 8; nástrčné kľúče ø 6; 8; 10; PH1; PH2; PH3; PZ1; PZ2; PZ3; SL6; SL8; T20; T25; držiak bitov záhlbníkový vrták</p> <p>*****</p>	
<p><b>Sada bitov a vrtákov 60 ks</b></p> <p>E-11829 30,99 € (MOC s DPH)</p> <p>bity 25 mm: PZ0 1 ks; PZ1 2 ks; PZ2 6 ks; PZ3 2 ks; PH1 1 ks; PH2 1 ks; PH3 1 ks; T15 1 ks; T20 1 ks; HEX3 1 ks; HEX4 1 ks; HEX5 1 ks; HEX6 1 ks; SL0,5 x 3 1 ks; SL0,8 x 4 3 ks; SL0,8 x 5 1 ks; SL1 x 5,5 2 ks; SL1 x 6 1 ks; SL1,2 x 6,5 3 ks; SL1,2 x 7 1 ks; bit s dorazom 1 ks; magnetický držiak bitov 60 mm 1ks; záhlbník 36 1 ks; Nástrčné kľúče: 5; 6; 7; 8; 9; 10; 11 x 38 mm Vrták do dreva s valcovitou stopkou Ø mm: 3; 4; 5; 6; 7; 8; Vrták do kovu HSS-TiN Ø mm: 2; 3 2 ks; 3,2; 4; 4,5; 5; Vrták do muriva s valcovitou stopkou Ø mm: 5; 5,5; 6; 7; 8;</p>		<p><b>Sada bitov a vrtákov 102 ks</b></p> <p>B-68432 59,99 € (MOC s DPH)</p> <p>PH1; PH2; PH3; PZ1; PZ2; PZ3; H3; H4; H5; H6; H7; SL3; SL4; SL6; SL7; SL8; T10; T15; T20; T25; T30; držiak bitov magnetický 60 mm vrtáky do železa, muriva, dreva nástrčné kľúče, záhlbníkový vrták</p> <p>*****</p>	
<p><b>Sada bitov 32 ks, balenie 12 ks</b></p> <p>D-74762-12 179,99 € (MOC s DPH)</p> <p>PH1(2 ks); PH2(4 ks);PH3; PZ1(2 ks); PZ2(5 ks) T10(2 ks); T15(2 ks); T20(2 ks); T25(3 ks) T30(2 ks); T40; LS4; SL5,5; SL6,5; Magnetický nadstavec s poistkou 60 mm Adaptér šesťhran na štvorhran</p>		<p><b>Sada bitov a vrtákov 71 ks</b></p> <p>D-33691 99,99 € (MOC s DPH)</p> <p>vrták HSS TiN 1,5; 2; 2,5; 3; 3,5; 4; 4,5; 5; 5,5; 6; 6,5; 7 vrták do dreva 4; 5; 6; 8; 10 vrták do kameňa 3; 4; 6; 8 vrták plochý do dreva 8; 15; 20 nástrčný kľúč 8; 10; 12; 13 zalamovací nôž, meter 3 m 2 × PH1, 2 × PH2, 2 × PH3 × 25 mm 2 × PZ1, 2 × PZ2, 2 × PZ3 × 25 mm T20, T25, T30, T40 × 25 mm SL1, SL1,2, SL1,6, H3, H4, H5, H6 × 25 mm 2 × magnetický držiak bitov 50 mm 10 × bit 50 mm</p> <p>*****</p>	



<p><b>Sada bitov 30 ks</b></p> <p>Bity 50 mm: PH1; PH2 x 2 ks; PH3; PZ2; SL5,5; T25; T30            Bity 25 mm: PH1; PH2 x 2 ks; PH3; PZ1; PZ2; PZ3; T20            T25; T30; H3; H4; H5; H6; SL5,5; SL6,5;            Nástrčný kľúč magnetický 48 mm: 8; 10; 12            Nástrčný kľúč upínanie 3/8": 17; 19;            Adaptér 1/4" na 3/8" x 50 mm            Magnetický držiak bitov 60 mm</p>	<p><b>E-07060</b>      <b>41,99 €</b> (MOC s DPH)</p> 	<p><b>Sada bitov 32 ks</b></p> <p>Bity 75 mm: PH1; PH2; PZ1; PZ2; SL5,5; T30; SL5,5; SL6,5;            Bity 25 mm: PH0; PH1; PH2 x 3 ks; PH3; PZ0; PZ1;            PZ2 x 2 ks; PZ3; H3; H4; H5; H6; T10; T15; T20; T25; T30; H3; H4; H5; H6; SL0.5 x 3;            SL0.5 x 4; SL0.8 x 5.5; SL1.2x6.5            Magnetický držiak bitov 60 mm</p>	<p><b>E-07076</b>      <b>25,99 €</b> (MOC s DPH)</p> 
<p><b>Sada bitov a vrtákov 18 ks</b></p> <p>Bity 50 mm: PH1; PH2 x 2 ks; PZ1; PZ2; PZ3;            SL5,5; T30; SL0.8 x 5.5; SL1.2 x 6.5;            Nástrčný kľúč magnetický 48 mm: 6; 8; 10; 12            Vrták do betónu SDS-PLUS 160 mm: Ø 5; 6 x 2 ks; 8; 10;            Magnetický držiak bitov Quick systém 80 mm</p>	<p><b>E-07026</b>      <b>33,99 €</b> (MOC s DPH)</p> 	<p><b>Sada bitov a vrtákov 29 ks</b></p> <p>Bity 25 mm: PH1; PH2; PZ0; PZ1; PZ2; PZ3; H3; H4; H5; H6; T10; T15; T20; T25; H3; H4; H5; H6; SL0.5 x 3; SL0.8 x 5; SL1 x 6            Magnetický držiak bitov Quick systém 80 mm            Vrtáky do kovu HSS-Tin Ø : 3; 4; 5; 6; 8            Vrtáky do betónu Ø: 4; 5; 6; 8;            Vrtáky do dreva: Ø: 5; 6; 8;</p>	<p><b>E-07054</b>      <b>35,99 €</b> (MOC s DPH)</p> 
<p><b>Gola sada 212 ks</b></p> <p>račňa 1/2"; 1/4"; križový kľúč 1/4"            predĺženie 1/4" 50; 100 mm; 1/2" 50; 100 mm            adaptér 1/2" na 3/8"            kľbový adaptér 1/4" na 1/4"; 1/2" na 1/2"            kľúč na sviečky 1/2" 16; 21 x 65 mm            orech šesťhran 1/4": 4; 4,5; 5; 5,5; 6; 7; 8; 9; 10; 11; 12; 13; 14 x 25 mm            orech šesťhran 1/2": 15; 16; 17; 19; 20; 21; 22; 24 x 38 mm; 27 x 40 mm; 30; 32 x 44 mm            orech hviezda 1/2": E10; E12; E14; E16; E18; E20; E24 x 38 mm            kľúč nástrčný 1/4": 5; 5,5; 6; 7; 8 x 2; 9; 10 x 2; 11; 12; 13 x 38 mm            kľúč očko/vidlica: 8; 10; 11; 12; 13; 14; 15; 16; 17; 18; 19            sada imbusov do ruky: 1,5; 2; 2,5; 3; 4; 5; 6; 8            rukoväť skrutkovača 1/4" samec; 1/4" samica            bity 1/4" x 37 mm SL4; SL5; SL6; PH1; PH2; PH3; PZ1; PZ2; PZ3; T10; T15; T20; T25; T27; T30; T40; HEX3; HEX4; HEX5; HEX6            adaptér bitu 1/4" na 1/4" x 25 mm; 1/2" na 5/16" x 38 mm            predĺžovací adaptér 1/4" 80 mm            magnetický adaptér 1/4" 60 mm            bity 25 mm PH0 5ks; PH1 5ks; PH2 20ks, PH3 5ks, PH4; T8 2ks; T9 2ks; T10 2ks; T15 2ks; T20 2ks; T25; T27; T30; T40; T9H; T10H; T15H; T20H; T25H; T27H; T30H 2ks;            T40H; PZ0 2 ks; PZ1 2ks; PZ2 3ks; PZ3 2 ks; PZ4; SL3 2 ks; SL4 2 ks; SL5 2 KS;            SL5,5 2ks; SL6,5 2 KS; H3; H4; H5; H6; H7; H8; H3H; H4H; H5H; H6H            bity 30 mm PH3; PH4; PZ3; PZ4; T25; T27; T30; T35; T40; T45; T50; H4; H5; H6; H7; H8; SL6; SL7; SL8; T25H; T27H; T30H; T35H; T40H; T45H; T50H; M5; M6; M8; M10</p>		<p><b>E-10883</b>      <b>241,99 €</b> (MOC s DPH)</p> 	
<p><b>Sada ručného náradia 256 ks</b></p> <p>Vrtáky do kovu HSS-R Ø mm: 1; 1,5; 2; 2,5; 3; 3,2; 3,5; 4; 4,5; 5; 5,5; 6; 7; 7,5; 8;            Vrtáky do dreva špirálové Ø mm 3; 4; 5; 6; 7; 8; 9; 10;            Vrtáky do dreva ploché Ø mm 12; 16; 20; 22; 25 x 150 mm            Vrtáky do muríva Ø mm: 3; 4; 5; 6; 7; 8; 10;            Vrták záhlbníkový; dorazové krúžky: 3; 5; 8; 10;            Bit 25 mm: PH0; PH1; PH2; PH3; PH4; PZ0; PZ1; PZ2; PZ3; PZ4; SL4,5; SL5,5; SL6; SL6,5; SL7; H3; H4; H5; H6; T10; T15; T20; T25; T27; T30; T40; bit s dorazom;            Bit 50 mm: PH1; PH2; PH3; PZ1; PZ2; PZ3; adaptér 1/4" na 1/4"; 1/4" na 3/8"            Magnetický držiak bitov 60 mm            Nástrčné kľúče: 5/32"; 3/16"; 7/32"; 1/4"; 9/32"; 5/16"; 11/32"; 3/8"; 7/16"; 1/2"; 5; 5,5; 6; 7; 8; 9; 10; 11; 12; 13;            Vykružovacie korunky do dreva Ø mm: 32; 38; 45; 54; adaptér k vykružovacím korunkám, mierka otvorov;            adaptér k vykružovacím korunkám, mierka otvorov;            Imbusový kľúč: 1,5; 2; 2,5; 3; 4; 5; 5,5; 6; 1/16; 5/64; 3/32; 1/8; 5/32; 3/16; 7/32; 1/4;            meter 3 m; olamovací nôž; vodováha; skrutkovač na bity; nastaviteľný kľúč, ceruzka Makita;            Rozmer kufríka (D x Š x V): 340 x 315 x 111 mm</p>		<p><b>E-11689</b>      <b>140,99 €</b> (MOC s DPH)</p>	

# SKRUTKOVÁČE

**Sada bitov a vrtákov 34 ks** **D-36980** **37,99 €** (MOC s DPH)

vrták HSS 2; 2,5; 3; 3,5; 4; 4,5; 5;  
vrták do dreva 4; 5; 6; 7; 8  
vrták do kameňa 4; 5; 6; 7; 8  
nástrčný kľúč 7; 8; 10;  
záhlbníkový vrták  
držák bitov magnetický 50 mm  
PH1, PH2, PH3, PH4, PZ1, PZ2, PZ3,  
PZ4  
T20, T25, T30, SL1, SL1,2, SL1,6



\*\*\*\*\*

**Sada bitov a vrtákov 102 ks** **E-10730** **63,99 €** (MOC s DPH)

25 mm bity PZ1, PZ2, PZ3, PH1, PH2,  
PH3,  
SL3, SL4, SL4,5, SL6, SL7, SL8  
T10, T15, T20, T25, T27, T30  
H3, H4, H5, H6, H7  
50 mm bity PZ0, PZ1, PZ2, PZ3,  
PH1, PH2, PH3  
T10, T20, T25, T27,  
H3, H4, H5, H6, SL3, SL4, SL 4,5  
záhlbníkový vrták  
držák bitov magnetický 60 mm  
nástrčný kľúč 5; 5,5; 6; 7; 8; 9; 10; 11;  
12; 13  
doraz 3; 5; 8; 10; imbus kľúč 2,5 mm  
priebojník  
vrták do dreva ø 3; 4; 5; 5,5; 6; 6,5;  
vrták HSS TiN ø 3; 4; 5; 5,5; 6; 6,5;  
vrták do muriva ø 3; 4; 5; 5,5; 6; 6,5;  
vrták do dreva plochý ø 12; 16; 19  
korunka BiMetal ø 32; 38; 45; 54;  
adaptér korunky  
rukoväť skrutkovača  
vodováha, meter, šablóna s priemerami



\*\*\*\*\*

**Sada bitov a vrtákov v systainery 69 ks** **B-49638** **106,99 €** (MOC s DPH)

25 mm bity PH0; PH1; PH2; PH3;  
PZ0; PZ1; PZ2; PZ3  
T10; T15; T20; T25; T30; T40;  
T10H; T15H; T20H; T25H; T27H;  
T30H; T40H;  
SL4; SL4,5; SL5,5; SL6,5; H3; H4; H5;  
H6;  
50 mm bity PH2; PZ2;  
nástrčný kľúč 6; 8; 10; 12; 13;  
vrták HSS-G ø 3; 4; 5; 6; 8;  
vrták do dreva ø 3; 4; 5; 6; 8;  
vrták do muriva ø 5; 6; 8; 10  
vrták do dreva plochý ø 16; 20;



\*\*\*\*\*

**Sada ručného náradia a bitov 76 ks.** **E-10899** **139,99 €** (MOC s DPH)

adaptér 1/4" na 3/8", adaptér 1/2" na 3/8",  
predĺženie 3/8" 75 mm, predĺženie 3/8" 150 mm,  
magnetický držák bitov 1/4" 60 mm  
nástrčné kľúče 1/4": 5; 6; 7; 8; 9; 10; 11 x 38 mm,  
bity 1/4" SL: 0,5 x 3; 0,8 x 4; 0,8 x 5; 1 x 5,5; 1 x 6 x 25 mm  
TX: 8; 9; 10; 15; 20; 25; 27; 30; 40 X 25 mm,  
THX: 8; 9; 10; 15; 20; 25; 27; 30; 40 X 25 mm,  
PH 1; 2; 3 x 25 mm  
račňa 3/8", skrutkovač 1/4" pre nástrčné kľúče,  
nôž odlamovací, skrutkovač 1/4" pre bity,  
tesárske kladivko, kliešte (kombinačky) 2 ks,  
adaptér uhlový 1/4", adaptér uhlový 3/8",  
orechy 3/8" : 8; 9; 10; 11; 12; 13; 14; 15; 16 x 28 mm, 17; 18; 19; 20; 21 x 30 mm,  
nástrčný TX 1/4" : 4; 5; 6; 7; 8 x 25 mm, 3/8" 10; 11; 12; 14; 16; 18 x 28 mm,



**Sada bitov a vrtákov 212 ks** **E-06270** **114,99 €** (MOC s DPH)

25 mm bity PH0; PH1; PH2; PH3;  
PH4; PZ0; PZ1; PZ2; PZ3  
SL3; SL4; SL5; SL5,5; SL6; SL7; SL8;  
H3; H4; H5; H6; H7; H8;  
T10; T15; T20; T25; T27; T30; T35;  
T40; T45; SQ1; SQ2; SQ3; SQ4;  
50 mm bity PH0; PH1; PH2; PH3;  
PZ0; PZ1; PZ2; PZ3  
SL3; SL4; SL5; SL6; SL7; SL8; H3;  
H4; H5; H6; H7; H8;  
T10; T15; T20; T25; T27; T30; T35;  
T40; T45;  
nástrčný kľúč 5; 5,5; 6; 7; 8; 9; 10; 11;  
12; 13; 5/35; 3/16; 7/32; 1/4;  
9/32; 5/16; 11/32; 3/8; 7/16; 1/2;  
záhlbníkový vrták  
držák bitov magnetický 60 mm  
doraz 3; 5; 8; 10; imbus kľúč 2,5 mm  
korunka BiMetal ø 32; 38; 45; 54;  
adaptér korunky  
vodováha, meter 3M, šablóna  
s priemerami; ohybný hriadeľ  
rukoväť skrutkovača; rukoväť v tvare  
„T“; priebojník; tužka Makita;  
vrták HSS ø 1; 1,5; 2; 2,5; 3; 3,2; 3,5;  
4; 4,5; 5; 5,5; 6; 6,5; 7; 7,5; 8; 9; 10;  
vrták do muriva ø 3; 4; 4,5; 5; 5,5; 6;  
6,5; 7; 8; 9; 10  
vrták do dreva ø 3; 4; 5; 6; 7; 8; 9; 10;  
vrták do dreva plochý ø 12; 16; 18;  
20; 22; 25;



\*\*\*\*\*



**Sada bitov a vrtákov 200 ks** **D-37194** **242,99 €** (MOC s DPH)

25 mm bity PH0; PH1; PH2; PH3;  
PZ0; PZ1; PZ2; PZ3; T10; T15; T20;  
T25; T30; T35; T40; SL3; SL4; SL5;  
SL6; SL8; H3; H4; H5; H6; H8; 50 mm  
bity PH0; PH1; PH2; PH3; PZ0; PZ1;  
PZ2; PZ3; T10; T15; T20; T25; T30;  
T35; T40;  
nástrčný kľúč 5; 5,5; 6; 7; 8; 9; 10; 11;  
12; 13; orech: 5, 6, 7, 8, 9, 10, 11, 13  
korunka BiMetal ø 32; 38; 45; 54; 68;  
vrták HSS ø 1; 1,5; 2; 2,5; 3; 3,2; 3,5;  
4; 4,5; 5; 5,5; 6; 6,5; 7; 7,5; 8; 10;  
vrták do dreva ø 3; 4; 5; 6; 7; 8; 10;  
vrták do dreva plochý ø 8; 15; 20;  
vrták do muriva ø 3; 4; 5; 6; 7; 8; 10  
vodováha, meter 3M, šablóna  
s priemerami; ohybný hriadeľ  
rýchlopínací držák bitu 50 mm;  
nastavovací kľúč; skrutkovač na bity;  
kliešte, odstrihávacie kliešte;  
baterka LED; orezávací nôž;  
záhlbníkový vrták



\*\*\*\*\*

# SKRUTKOVAČE: PROFESIONÁLNE BITY

typ	model	dĺžka mm	ks/bal	Obj. č.	MOC s DPH
<b>Profesionálne bity pre skrutkovače</b> <span style="float: right;">*****</span>					
	PH2	25	10	P-06052	8,99 €
	PZ2	25	10	P-06111	9,99 €
	T40	25	10	P-06389	12,99 €

<b>Bity pre skrutkovače so zásobníkom</b> <span style="float: right;">*****</span>						
	PH2	6842, 6843, DFR540, DFR550	157	3	P-67795	24,99 €
	PH2	DFR452	137	5	191V01-2	30,99 €
	PZ2	DFR452	137	5	191V05-4	35,99 €
	SQ2	DFR452	137	5	191V03-8	39,99 €
	PH2	DFR551	155	5	191V02-0	21,99 €
	PZ2	DFR551	155	5	191V06-2	38,99 €
	SQ2	DFR551	155	5	191V04-6	41,99 €

**Predĺženie rukoväti pre modely** **194500-1** **77,99 €** (MOC s DPH)

6840 / 6841 / 6841R/ 6842 / 6843  
6844 / 6845/ DFR440/540/550/750  
predĺženie 56 – 66 cm



\*\*\*\*\*

**Automatický podávač skrutiek** **191L24-0** **118,99 €** (MOC s DPH)

pre skrutky v pásoch  
dĺžky 25 – 55 mm  
kompatibilný s modelmi:  
DFS452, DFS250, FS6300,  
FS4300, FS4000, FS2300, DFS251.  
dodávaný s 2 x 130 mm PH2



\*\*\*\*\*

Typ	model	ø (mm)	povrchová úprava	dĺžka mm	ks na pásce	bal/ks	Automatický podávač 25 – 55 mm	Obj. č.	MOC s DPH
<b>Skrutky do sadrokartónu upevneného do kovovej konštrukcie</b> <span style="float: right;">*****</span>									
PH2	DFR540/DFR550/6842/6843/6845	3,9	fosfátované	25	50	1000	áno	F-30913	38,99 €
PH2	DFR540/DFR550/6842/6843/6845	3,9	fosfátované	30	50	1000	áno	F-30926	20,99 €
PH2	DFR540/DFR550/6842/6843/6845	3,9	fosfátované	35	50	1000	áno	F-31153	23,99 €
PH2	DFR540/DFR750/6842/6843/6845	3,9	fosfátované	45	50	1000	áno	F-30939	35,99 €
PH2	DFR540/DFR55/DFR750/6842/6843/6845	3,9	fosfátované	55	50	1000	áno	F-30942	30,99 €

<b>Skrutky do sadrokartónu upevneného do dreva</b> <span style="float: right;">*****</span>									
PH2	DFR540/DFR550/6842/6843/6845	3,9	fosfátované	35	50	1000	áno	F-31179	25,99 €
PH2	DFR540/DFR550/6842/6843/6845	3,9	fosfátované	41	50	1000	áno	F-31182	24,99 €
PH2	DFR540/6842/6843/6844	3,9	fosfátované	55	50	1000	áno	F-31140	32,99 €

<b>Skrutky pre dosky typu Fermacell upevnené do kovovej konštrukcie</b> <span style="float: right;">*****</span>									
PH2	DFR550	3,5	fosfátované	35	50	1000	áno	F-31195	33,99 €

<b>Stavebné skrutky do dreva</b> <span style="float: right;">*****</span>									
PH2	DFR540/DFR550/6842/6843/6845	4,2	pozinkované	40	50	1000	áno	F-31201	28,99 €
PH2	DFR540/DFR550/DFR750/6842/6843	4,2	pozinkované	55	50	1000	áno	F-31214	35,99 €

<b>Stavebné rýchloskrutky pre trieskové a OSB dosky</b> <span style="float: right;">*****</span>									
PH2	DFR540/DFR550/6842/6843/6845	4,0	biely zinok	35	50	1000	áno	F-31777	21,99 €
PH2	DFR540/DFR550/6842/6843/6845	4,0	biely zinok	40	50	1000	áno	F-31780	27,99 €

# POUŽITIE SKRUTKOVÁČOV

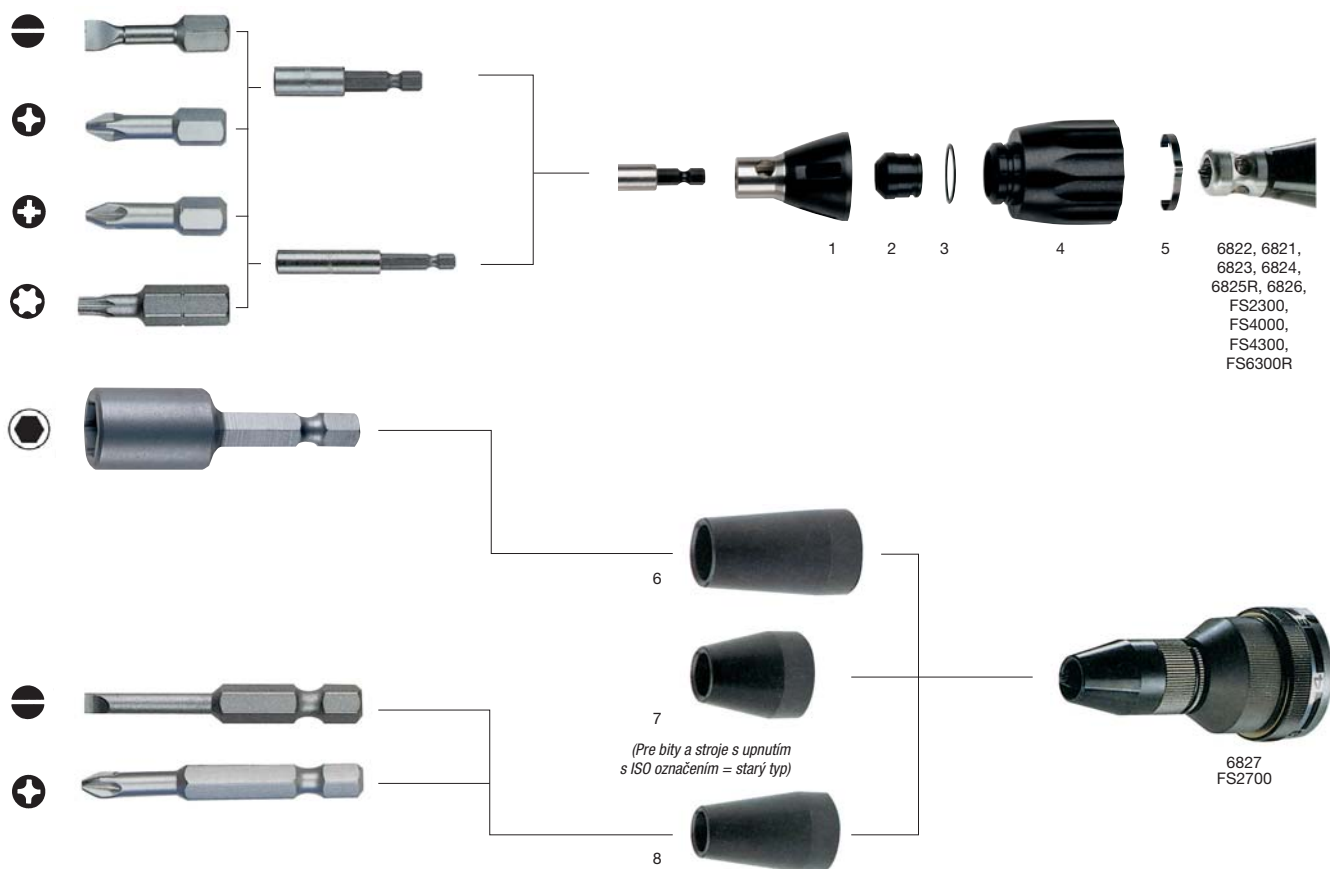



obr. č.	popis	ø	ks/bal.	model	Obj. č.	MOC s DPH
1	vodiace puzdro		1	6823, 6824, 6825R	151760-8	3,59 €
1	vodiace puzdro	1/4"	1	6821, 6826	152483-1	3,49 €
1	vodiace puzdro		1	FS2300, FS4000, FS4300, FS6300R	158875-2	5,69 €
2	tesniaci krúžok		1	6822, 6823, 6824, 6825R	421631-6	0,67 €
2	tesniaci krúžok		1	FS2300, FS4000, FS4300, FS6300R	424163-2	0,22 €
2	prachovka		1	6821	421519-0	0,53 €
2	prachovka		1	6826	421775-2	0,58 €
3	o-krúžok 22		1	6821, 6822, 6823, 6824, 6825R, 6826	213953-6	0,13 €
3	o-krúžok		1	FS2300, FS4000, FS4300, FS6300R	424235-3	0,22 €
4	nastavovacie puzdro		1	6822	416756-9	3,56 €
4	nastavovacie puzdro		1	6823, 6824, 6825R, 6827	455428-1	3,38 €
4	nastavovacie puzdro		1	6821	415570-0	1,96 €
4	nastavovacie puzdro		1	FS2300, FS4000, FS4300, FS6300R	455591-0	3,38 €
5	pružina		1	6822, 6823, 6824, 6825R, 6826, 6821	232154-7	1,11 €
5	pružina		1	FS2300, FS4000, FS4300, FS6300R	232245-4	2,43 €
5	pružina		1	FS2300, FS4000, FS4300, FS6300R	234266-2	1,16 €
4	nastavovacie puzdro		1	6823, 6824, 6825R, 6827	455428-1	3,38 €
	adaptér		1	6821, 6822, 6823, 6824, 6825R, 6826, 6827	134873-0	42,99 €

# RÁZOVÉ UŤAHOVÁKY: PRÍSLUŠENSTVO

	upínanie	typ	dĺžka mm	ks/bal	Obj. č.	MOC s DPH
<b>Predĺženie</b> <span style="float: right;">*****</span>						
	1/2"		100	1	134874-8	31,99 €
	3/4"		150	1	134997-2	62,99 €
	1"		200	1	134870-6	111,99 €

<b>Kíbový adaptér</b> <span style="float: right;">*****</span>						
	1/2"		100	1	134877-2	104,99 €

<b>Adaptér redukcia</b> <span style="float: right;">*****</span>						
	1/2" na 1/4"			1	134873-0	42,99 €
	1/2" na 1/4"			1	B-68448	16,99 €
	1/2" na 1/4"			1	P-05941	53,99 €
	1/4" 6 hran na 1/4"			1	D-74740	1,49 €
	1/2" na 7/16" 6 hran			1	B-68460	22,99 €
	O krúžok pre P-05941			1	P-21559	3,07 €
čap pre P-05941			1	P-21565	1,15 €	

<b>Nástrčné kľúče s upnutím štvorhran 1/2"</b> <span style="float: right;">*****</span>						
	1/2"	M8/SW13	38	1	134825-1	4,89 €
	1/2"	M8/SW13	52	1	134827-7	6,79 €
	1/2"	M10/SW17	38	1	134829-3	5,49 €
	1/2"	M10/SW17	52	1	134830-8	6,89 €
	1/2"	M12/SW19	38	1	134831-6	5,39 €
	1/2"	1/2"/SW21	38	1	134838-2	6,69 €
	1/2"	1/2"/SW21	52	1	134833-2	6,09 €
	1/2"	M14/SW22	38	1	134851-0	6,09 €
	1/2"	M14/SW22	52	1	134834-0	8,09 €
	1/2"	M16/SW24	45	1	134841-3	8,19 €
	1/2"	M16/SW24	52	1	134836-6	8,19 €
	1/2"	M18/SW27	50	1	134844-7	10,19 €
	1/2"	M18/SW27	78	1	134845-5	12,99 €
	1/2"	M20/SW30	50	1	134846-3	10,99 €
	1/2"	M20/SW30	78	1	134847-1	13,99 €
	1/2"	M22/SW32	50	1	134848-9	10,19 €
	1/2"	M22/SW32	78	1	134849-7	14,99 €
	1/2"	O krúžok k nástrčným kľúčom		1	213643-1	0,67 €
	1/2"	čap k nástrčným kľúčom		1	268057-9	1,16 €

<b>Nástrčné kľúče s upnutím štvorhran 1/2"</b> <span style="float: right;">*****</span>						
1/2"	M5/SW8	81,5	1	B-52146	4,19 €	
1/2"	M6/SW10	81,5	1	B-52152	4,19 €	
1/2"	SW12	81,5	1	B-52174	4,19 €	
1/2"	M8/SW13	81,5	1	B-52180	4,19 €	
1/2"	SW14	81,5	1	B-52196	4,59 €	
1/2"	SW16	81,5	1	B-52205	4,59 €	
1/2"	M10/SW17	81,5	1	B-52211	5,39 €	
1/2"	M12/SW19	81,5	1	B-52233	6,09 €	
1/2"	SW21	81,5	1	B-52249	7,09 €	
1/2"	SW22	81,5	1	B-52255	7,69 €	
1/2"	M16/SW24	81,5	1	B-52261	8,69 €	
1/2"	M18/SW27	81,5	1	B-52277	9,49 €	
1/2"	M20/SW30	81,5	1	B-52283	10,49 €	
1/2"	M22/SW32	81,5	1	B-52299	13,99 €	

# RÁZOVÉ UŤAHOVÁKY: PRÍSLUŠENSTVO

upínanie	typ	dĺžka mm	ks/bal	Obj. č.	MOC s DPH
<b>Nástrčné kľúče s upnutím štvorhran 3/4"</b> <span style="float: right;">*****</span>					
	M12/SW19	50	1	A-85519	12,99 €
	M14/SW22	52	1	A-85553	11,99 €
	M16/SW24	52	1	A-85575	11,99 €
	M18/SW27	52	1	134855-2	12,99 €
	M18/SW27	95	1	134856-0	25,99 €
	M20/SW30	52	1	134857-8	12,99 €
	M20/SW30	95	1	134858-6	23,99 €
	M22/SW32	52	1	134871-4	12,99 €
	M22/SW32	95	1	134859-4	25,99 €
	M24/SW36	56	1	134862-5	17,99 €
	M24/SW36	95	1	134863-3	29,99 €
	3/4"	O krúžok k nástrčným kľúčom		1	213506-1
3/4"	čap k nástrčným kľúčom		1	256282-4	1,24 €

<b>Nástrčné kľúče s upnutím štvorhran 1"</b> <span style="float: right;">*****</span>						
	1"	M24/SW36	80	1	134865-9	25,99 €
	1"	M27/SW41	80	1	134872-2	33,99 €

**Sada nástrčných kľúčov 9ks** **E-16645** **cena na vyžiadanie** (MOC s DPH)

upínanie 1/2"  
8, 10, 12, 13, 14, 15, 17, 18 x 30 mm  
adaptér 1/4" na 1/2"



**Sada nástrčných kľúčov 3 ks** **E-12354** **40,99 €** (MOC s DPH)

upínanie 1/2"  
kľúč 17, 19, 21 x 86 mm



**Sada nástrčných kľúčov 7ks** **B-69733** **40,99 €** (MOC s DPH)

upínanie 1/2"  
13, 17, 19, 21, 22, 24 x 30 mm  
adaptér 1/4" na 1/2"



**Sada nástrčných kľúčov 9ks** **B-54651** **26,99 €** (MOC s DPH)

upínanie 3/8"  
8, 10, 12, 13, 14, 15, 17, 18 x 30 mm  
adaptér 1/4" na 3/8"



**Predĺženie k rázovým uťahovákam** **191G67-2** **141,99 €** (MOC s DPH)

vhodné pre modely  
DTW1001, DTW1002, DTW800  
DTW700, TW001G,  
TW002G, TW003G, TW007G,  
TW008G  
nastavenie dĺžky: 657 – 807 mm



**Sada nástrčných kľúčov 8ks** **E-12289** **14,99 €** (MOC s DPH)

upínanie 1/4"  
6; 7; 8; 10; 11; 12; 13;  
adaptér 1/4" na šesťhran



## Diamantové kotúče typy



### Segmentový:

Najčastejšie používaný s diamantami v sadenými po okrajoch kotúča. Rýchle a pohodlné rezanie.



### Segmentový zváraný laserom:

vrstva diamantu a kotúča sú zvárané laserovým lúčom nad 1000 ° C. Ideálne použitie s vysoko výkonným strojom.

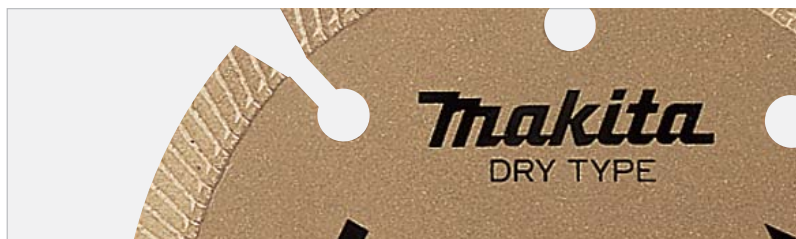

### Segmentový so zárezmi:

tieto zárezy zabezpečujú:

- rýchle rezanie s menším odporom
- efektívnejšie odvádzanie rezného prachu
- menšia záťaž na kotúč



### Turbo hrana:

rýchlejšie rezanie ako pri segmentových kotúčoch  
čistejší rez bez štrbín na rezanom materiále



### Nedelená hrana:

Vrstva diamantov po celom obvode kotúča  
čistý a hladký rez aj na tvrdých materiáloch  
/keramické obklady, porcelán/

## REZANIE: REZNÉ KOTUČE

upínanie ø otvoru (mm)	ø (mm)	materiál	typ	ks/bal	Obj. č.	MOC s DPH
------------------------------	--------	----------	-----	--------	---------	-----------

### X-LOCK diamantový rezný kotúč



X-LOCK	125	betón	segmentový	1	E-02076	40,99 €
--------	-----	-------	------------	---	---------	---------

diamantový rezný kotúč určený pre akumulátorové uhlové brúsky X-LOCK – systém uchytania kotúča bez použitia kľúča umožňuje bezpečnú a rýchlu výmenu kotúča možnosť použitia kotúča aj pre štandardné brúsky s upínaním 22,23 mm

### Diamantový rezný kotúč pre akumulátorové uhlové brúsky



22,23	125	betón, žula, mramor	segmentový	1	B-53796	48,99 €
22,23	125	železo	segmentový	1	B-53693	54,99 €

### Diamantový rezný kotúč pre akumulátorovú rozbrusovačku CE001



25,4	355	betón, žula, mramor	segmentový (výška segmentu 8 mm)	1	E-12996	171,99 €
------	-----	------------------------	---	---	---------	----------

### Diamantový rezný kotúč na rezanie na mokro



ø otvoru (mm)	ø (mm)	hrúbka segmentu (mm)	výška segmentu (mm)	materiál	typ	bal/ks	obj. č.	MOC s DPH
15	85	2	4,5	sklo, obkladačky	hladký	1	B-21098	33,99 €

vhodný pre modely 4190DW, 4191DWA, CC300, CC301





# REZANIE: REZNÉ KOTUČE

ø (mm)	výška segmentu (mm)	ø otvoru (mm)	ID číslo kotúča	charakteristika	prstenec (mm)	ks./bal	Obj. č.	MOC s DPH	
<b>Diamantové kotúče Quasar</b> <span style="float: right;">*****</span>									
	230	12	22,23	QDS23022XS	3DDG, Stealth		1	B-12712	120,99 €
	350	12	25,4	QDS35025XS	3DDG, Stealth	20	1	B-13465	221,99 €
	400	12	25,4	QDS40025XS	3DDG, Stealth	20	1	B-13471	267,99 €

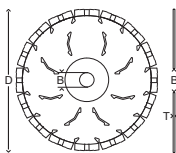

## Ako čítať nový identifikačný kód diamantových kotúčov Makita



**QDS30020XS**

Typ segmentu (Segment Type)  
 DS = diamantový segmentovaný  
 DT = diamantový turbo  
 DC = diamantový nedelený  
 DE = diamantový elektrolyticky pokovovaný  
 DM = diamantový na maltu (frézovanie škár)  
 DA = diamantový asfaltový

Priemer otvoru (v mm) (Bore Diameter)  
 15 = 15mm  
 16 = 16mm  
 20 = 20mm  
 22 = 22.23mm  
 25 = 25.4mm

**QDS30020XS**

Označenie (Brand)  
 Q = Quasar  
 C = Comet  
 N = Neutron  
 L = Laser (DiaMak+)  
 D = DiaMak

Priemer kotúča (v mm) (Blade Diameter)

Špecifické charakteristiky (Special Features)  
 e = Enduro  
 r = Rapide  
 C = chladiace otvory  
 V = spevnené jadro  
 X = technológia 3D Diamond Grid  
 S = technológia Stealth



### PRÍKLADY

QDS30020XS: kotúč Quasar, diamantový segmentovaný, priemer 300 mm, priemer otvoru 20 mm, technológia 3D Diamond Grid, technológia Stealth  
 CDS40025rCX: kotúč Comet, diamantový segmentovaný, priemer 400 mm, priemer otvoru 25 mm, Rapide, chladiace otvory, technológia 3D Diamond Grid  
 NDS11522e: kotúč Neutron – priemer 115 mm, priemer otvoru 22,23 mm, Enduro





## REZANIE: REZNÉ KOTUČE

Špeciálny univerzálny kotúč s technológiou 3D Grid pre profesionálny výkon.

Široké spektrum kvalitných kotúčov s technológiou 3D Grid a voliteľnými prvkami ako technológia Stealth alebo chladiace otvory.

K dispozícii v segmentových špecifikáciách Rapide a Enduro pre maximalizáciu rýchlosti alebo životnosti.

Zvárané laserom. Na mokré a suché použitie.

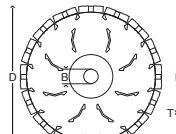
	ø (mm)	výška segmentu (mm)	ø otvoru (mm)	ID číslo kotúča	charakteristika	prstenec (mm)	ks/bal	Obj. č.	MOC s DPH
<b>Diamantové kotúče Comet</b> 									
 	125	10	22,23	CDS12522rC	Rapide, chladiace otvory	20	1	B-12778	42,99 €
	150	10	22,23	CDS15022C	Rapide, chladiace otvory		1	B-27187	55,99 €
	180	10	22,23	CDS18022C	Rapide, chladiace otvory		1	B-27193	71,99 €
	230	10	22,23	CDS23022rCX	3DDG, Rapide, chladiace otvory		1	B-12784	94,99 €
	350	10	25,4	CDS35025rCX	3DDG, Rapide, chladiace otvory	20	1	B-13552	169,99 €
	400	10	25,4	CDS40025rCX	3DDG, Rapide, chladiace otvory	20	1	B-13568	205,99 €

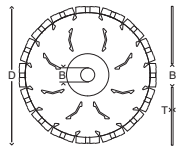

Segmentovaná hrana pre rýchle rezanie

Betón, stredne tvrdá/tvrdá tehla, terazzo, keramické dlaždice, bridlica, keramická rúra

 	115	7	22,23	CDT11522	štandardné jadro		1	B-12980	32,99 €
	125	7	22,23	CDT12522	štandardné jadro	20	1	B-12996	35,99 €
	200	7	30	CDT20030	štandardné jadro	25,4	1	B-13029	68,99 €
	230	8	22,23	CDT23022	štandardné jadro		1	B-13035	78,99 €
	300	8,5	25,4	CDT30025	štandardné jadro		1	B-13041	143,99 €
	350	8,5	25,4	CDT35025	štandardné jadro		1	B-13057	189,99 €

Turbo hrana na rezanie

Tvrdá tehla, žula, vápenec, keramická rúra, bridlica, terazzo, granit



 	80	5	15	CDC8015	štandardné jadro		1	B-13063	16,99 €
	115	5	22,23	CDC11522	štandardné jadro		1	B-13085	21,99 €
	125	5	22,23	CDC12522	štandardné jadro	20	1	B-13091	22,99 €
	200	5	30	CDC20030	štandardné jadro	25,4	1	B-13122	35,99 €
	230	5	30	CDC23030	štandardné jadro	25,4	1	B-13138	48,99 €
	300	7	25,4	CDC30025	štandardné jadro		1	B-13144	130,99 €
	350	7	30	CDC35030	štandardné jadro	25,4	1	B-13150	146,99 €

Nedelená hrana na rezanie keramiky, porcelánu, dlaždíc z mramoru a bridlice

 	115		22,23	CDE11522	štandardné jadro		1	B-13172	45,99 €
--	-----	--	-------	----------	------------------	--	---	---------	---------

Elektrolyticky pokovovaný kotúč na rezanie

Mramor, sklenené vlákno, drevovláknitá doska /sololit/, sklaminát

 	350	10	25,4	CDA35025	štandardné jadro	20	1	B-13275	172,99 €
	400	10	25,4	CDA40025	štandardné jadro	20	1	B-42905	251,99 €

Segmentovaná hrana, asfaltový kotúč na rezanie



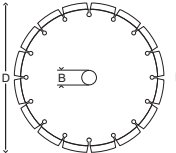

Asfalt, hrubozrnný vápenec, hrubozrnný pieskovec, abrazívny pieskovec, mäkká tvárnica

## REZANIE: REZNÉ KOTUČE

Špeciálny kotúč laserom zváraný na všeobecné použitie na stavebné materiály. Možno použiť na mokré alebo suché rezanie.

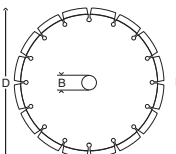
	ø (mm)	výška segmentu (mm)	ø otvoru (mm)	ID číslo kotúča	charakteristika	prstenec (mm)	ks/bal	Obj. č.	MOC s DPH
<b>Diamantové kotúče Nebula</b> <span style="float: right;">***</span>									
	125	10	22,23		suchý rez		1	B-53992	19,99 €
	150	10	22,23		suchý rez		1	B-54003	23,99 €
	180	10	22,23		suchý rez		1	B-54019	30,99 €
	230	10	22,23		suchý rez		1	B-54025	32,99 €
	300	10	20		suchý/mokrý rez		1	B-54031	62,99 €
	300	10	20		suchý/mokrý rez		1	B-54047	71,99 €
	350	10	25,4		suchý/mokrý rez	20	1	B-54053	75,99 €
	400	10	25,4		suchý/mokrý rez	20	1	B-54069	97,99 €
	450	10	25,4		suchý/mokrý rez		1	B-54075	215,99 €

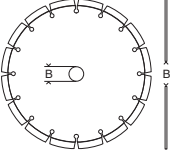
Segmentovaná hrana pre rýchle rezanie  
Betón, mäkká tehla, mäkká bridlica, betónové dlaždice

	ø (mm)	výška segmentu (mm)	ø otvoru (mm)	ID číslo kotúča	charakteristika	prstenec (mm)	ks/bal	Obj. č.	MOC s DPH
<b>Diamantové kotúče Diamak</b> <span style="float: right;">***</span>									
Ekonomické kotúče vstupnej úrovne vhodné pre široké spektrum stavebných materiálov. K dispozícii vo viacerých variantoch – segmentované, turbo a nedelené. Na použitie za mokra aj za sucha.									
	115	7	22,23	DDS115	Segmentový kotúč	za sucha	1	D-61123	6,69 €
	125	7	22,23	DDS125	Segmentový kotúč	za sucha	1	D-61139	7,49 €
	230	7	22,23	DDS230	Segmentový kotúč	za sucha	1	D-61145	17,99 €
Segmentovaná hrana – na rezanie Väčšina murárskych materiálov, dosky, tehly, blokový pieskovec, bridlica a vápenec.									
	115	7	22,23	DDT115	Turbo hrana	za sucha	1	D-61151	6,99 €
	125	7	22,23	DDT125	Turbo hrana	za sucha	1	D-61167	6,59 €
	230	7	22,23	DDT230	Turbo hrana	za sucha	1	D-61173	20,99 €
Turbo hrana – na rezanie Väčšina murárskych materiálov, dosky, tehly, blokový pieskovec, bridlica a vápenec.									
	115	7	22,23	DDC115	nedelená hrana	za mokra	1	D-61189	5,69 €
	200	7	25,4	DDC200	nedelená hrana	za mokra	1	D-61195	16,99 €
	250	7	30 / 25,4	DDC250	nedelená hrana	za mokra	1	D-61204	19,99 €
Nedelená hrana – na rezanie Na rezanie dlaždíc, mramoru, vápenca, porcelánu, terazza.									
	300	7,5	25,4	20	segmentový kotúč	za sucha	1	D-56982	66,99 €
	350	7,5	25,4	20	segmentový kotúč	za sucha	1	D-56998	91,99 €
	400	7,5	25,4	20	segmentový kotúč	za sucha	1	D-57009	106,99 €
Diamantové kotúče pre benzínové rozbrusovačky na betón									

## DELENIE: REZNÉ KOTUČE

ø (mm)	výška segmentu (mm)	ø otvoru (mm)	ID číslo kotúča	charakteristika	prstenec (mm)	ks/bal	Obj. č.	MOC s DPH
--------	---------------------	---------------	-----------------	-----------------	---------------	--------	---------	-----------

### Diamantové kotúče na betón pre uhlové brúsky



115	7	22,23		segmentový kotúč	za sucha	1	D-41589	8,49 €
125	7	22,23		segmentový kotúč	za sucha	1	D-41595	10,29 €
230	7	22,23		segmentový kotúč	za sucha	1	D-41610	22,99 €



115	7	22,23		turbo hrana	za sucha	1	D-41626	9,49 €
125	7	22,23		turbo hrana	za sucha	1	D-41632	10,99 €
230	7	22,23		turbo hrana	za sucha	1	D-41654	24,99 €

### Diamantové brúsne kotúče pre PW5000



ø (mm)	farba kotúča	zmo	bal/ks	obj. č.	Moc s DPH
100	modrá	50	1	D-15584	16,99 €
100	žltá	100	1	D-15590	16,99 €
100	oranžová	200	1	D-15609	14,99 €
100	červená	400	1	D-15615	14,99 €
100	tmavozelená	800	1	D-15621	14,99 €
100	svetlozelená	1500	1	D-15637	17,99 €
100	hnedá	3000	1	D-15643	18,99 €
100	zelená	dolešťovanie	1	D-15659	23,99 €
100	sada 8 ks		8	D-15805	131,99 €
100	brúsny tanier		1	743080-0	30,99 €

ø (mm)	ø otvoru (mm)	hrúbka segmentu (mm)	výška segmentu (mm)	druh segmentu	farba kotúča	použitie	max. otáčiky (min <sup>-1</sup> )	ks/bal	Obj. č.	MOC s DPH
--------	---------------	----------------------	---------------------	---------------	--------------	----------	-----------------------------------	--------	---------	-----------

### Diamantový brúsny kotúč pre PC1100



110	15	13	5,4	hladký	strieborná		13900	1	792289-1	300,99 €
-----	----	----	-----	--------	------------	--	-------	---	----------	----------

### Diamantový brúsny kotúč pre PC5000/5001



125	22,23	8	5	dvoj rad	zlatá	hrubé nečistoty		1	B-12295	107,99 €
125	22,23			hladký	zlatá	jemné čistenie		1	B-12289	256,99 €

### Diamantový brúsny kotúč pre PC5000/5001



125	M14	8	5,5	jedno rad	strieborná	hrubé nečistoty		1	B-48561	94,99 €
125	M14	8	5,5	dvoj rad	strieborná	hrubé nečistoty		1	B-48577	99,99 €

125	22,23	7	5	dvoj rad	strieborná	hrubé nečistoty		1	D-41458	53,99 €
125	22,23	8	5	jedno rad	strieborná	hrubé nečistoty		1	D-60682	20,99 €
125	22,23	7	5,5	dvoj rad	strieborná	hrubé nečistoty	12.250	1	D-66715	29,99 €
125	22,23	13	4,2	vejárový	strieborná	hrubé nečistoty	12.250	1	D-66721	33,99 €

### Diamantové brúsne kotúče z nízkymi vibráciami uchytenie M14



125	M14	7	5,5	tvar V	zlatá	hrubé nečistoty		1	B-48555	133,99 €
125	M14	15	4,5	vejárový	zlatá	hrubé nečistoty		1	B-49993	140,99 €

## Príslušenstvo pre prestrihovače, nožnice na plech, nožnice závitových tyčí a roxorov



model	rozmer	popis	obj. č.	Moc s DPH
DSC102, SC103D	M6	sada 2 ks	199087-8	106,99 €
	M8	sada 2 ks	199085-2	69,99 €
	M10	sada 2 ks	199083-6	70,99 €

DSC162, DSC162R, DSC163		sada 2 ks	SC09002470	236,99 €
-------------------------------	--	-----------	------------	----------

DSC191, DSC191R		sada 2 ks	SC09002030	341,99 €
--------------------	--	-----------	------------	----------

DSC251	110 x 15 mm 24Z		E-11097	58,99 €
--------	-----------------	--	---------	---------

DSC250	110 x 15 mm 24Z		E-11097	58,99 €
	adaptér		SC09030550	98,99 €

model	pozícia	popis	obj. č.	MOC s DPH
-------	---------	-------	---------	-----------

DJS130, JS1300	1	nôž stredný	792744-3	63,99 €
----------------	---	-------------	----------	---------



DJS131	1	nôž stredný	725256-1	52,99 €
--------	---	-------------	----------	---------



	2	nôž pravý	725257-9	274,99 €
--	---	-----------	----------	----------

	3	nôž ľavý	725258-7	271,99 €
--	---	----------	----------	----------

DJS200	1	nôž stredný	725255-3	96,99 €
--------	---	-------------	----------	---------



	2	nôž pravý	725092-5	57,99 €
--	---	-----------	----------	---------

	3	nôž ľavý	725093-3	60,99 €
--	---	----------	----------	---------

DJS800	1	nôž stredný	725129-8	89,99 €
--------	---	-------------	----------	---------



	2	nôž pravý	725130-3	87,99 €
--	---	-----------	----------	---------

	5	nôž ľavý	725130-3	87,99 €
--	---	----------	----------	---------

DJS100, DJS101, JS1000	1	Sada nožov (P + L)	792536-0	59,99 €
---------------------------	---	--------------------	----------	---------

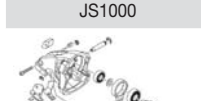

	2	nôž stredný	792537-8	102,99 €
--	---	-------------	----------	----------

DJS160, DJS161, JS1601		Sada nožov (P + L)	792533-6	58,99 €
---------------------------	--	--------------------	----------	---------

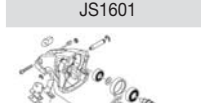

		nôž stredný	792534-4	80,99 €
--	--	-------------	----------	---------

JS1602, JS1600	1; 2; 3	Sada nožov (P + L)	191383-0	35,99 €
----------------	---------	--------------------	----------	---------

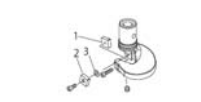

JS3201, JS3200	1; 2	Sada nožov (P + L)	792287-5	45,99 €
----------------	------	--------------------	----------	---------



		mierka ( 1,0; 1,5; 2,0 mm)	762007-1	2,29 €
--	--	-------------------------------	----------	--------

DJN160, DJN161, JN1601	1	matrica	A-15051	19,99 €
---------------------------	---	---------	---------	---------

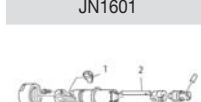

	2	razník	A-83951	25,99 €
--	---	--------	---------	---------

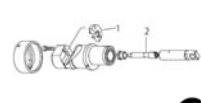

JN3201, JN3200	1	matrica	792292-2	26,99 €
----------------	---	---------	----------	---------

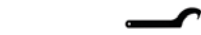

	2	razník	792728-1	34,99 €
--	---	--------	----------	---------



## DELENIE: REZNÉ KOTÚČE

	ø (mm)	ø otvoru (mm)	popis	hrúbka kotúča	ks/bal	Obj. č.	MOC s DPH
<b>Rezné kotúče</b>							
 <p>Rezný kotúč na kovy – Rezný kotúč, lisovaný za studena, s pojivom zo syntetickej živice. Univerzálny kotúč, použiteľný vo všetkých oblastiach opracúvania kovov. Vysoký rezný výkon pri dobrej životnosti.</p>	115	22,23		1,6	1	B-14102	1,59 €
	115	22,23		2,5	1	A-85307	1,39 €
	125	22,23		1,6	1	B-35134	1,79 €
	125	22,23		2,5	1	A-85313	1,69 €
	180	22,23		2,5	1	A-85329	2,39 €
	230	22,23		2,5	1	A-85335	3,29 €
	230	22,23		2	1	B-60464	3,29 €
	355	25,4		2,5	5	B-49448-5	31,99 €
	355	25,4		3	5	B-10665-5	28,99 €
	355	25,4		4,3	5	E-12790-5	79,99 €
	400	25,4		3	1	724417-0	42,99 €
	<p>Sada rezných kotúčov na kov</p>						
	125	22,23	kovová krabica	1,2	12	D-65969-12	11,99 €
	125	22,23	PVC krabica	0,8	12	E-10877-12	25,99 €
 <p>Rezný kotúč na kameň – Rezný kotúč, lisovaný za studena, s pojivom zo syntetickej živice. Univerzálny kotúč na rezanie prírodného a umelého kameňa, bridlice, mramoru, neželezných kovov. Vysoký rezný výkon pri dlhej životnosti</p>	125	22,23		3	1	A-85363	2,19 €
	180	22,23		3	1	A-85379	3,09 €
	230	22,23		3	1	A-85385	4,19 €
	300	20		3,5	1	721710-3	17,19 €
	400	25,4		4	1	724408-1	41,99 €
 <p>Rezný kotúč na nerez / železo – Tenký, stredne tvrdý, vysokovýkonný rezný kotúč. Vhodný najmä na tenkostenné materiály ako rúry, profily, plechy a drôty. Nižšie zaťaženie náradia, menšia spotreba materiálu, menšie úsilie pri rezaní. Mimoriadne vysoký rezný výkon pri optimálnej životnosti.</p>	76	10	Kartón	1	5	D-74815-5	3,89 €
	115	22,23		0,8	1	B-45727	1,89 €
	115	22,23		1,6	1	B-45755	1,29 €
	125	22,23		0,8	1	E-10877	2,19 €
	125	22,23		1,6	1	B-46931	1,39 €
	125	22,23	PVC krabica	1	12	E-17120-12	22,99 €
	100	16		1	1	E-03028	1,29 €
<p>Rezný kotúč na ušľachtilú oceľ – Tenký, stredne tvrdý, vysokovýkonný rezný kotúč. Vhodný najmä na tenkostenné materiály ako rúry, profily, plechy a drôty z nehrdzavejúcej ocele. Nižšie zaťaženie náradia, menšia spotreba materiálu, menšie úsilie pri rezaní. Mimoriadne vysoký rezný výkon pri optimálnej životnosti.</p>	115	22,23		1	1	E-03034	1,39 €
	125	22,23		1	1	E-03040	1,49 €
	125	22,23	X-LOCK	1,2	1	E-00418	2,59 €
	150	22,23		1,6	1	E-13742	1,99 €
	180	22,23		1,6	1	E-13758	1,99 €
	230	22,23		1,9	1	E-13764	3,39 €

## DELENIE: BRÚSNÉ KOTÚČE

ø (mm)	ø otvoru (mm)	popis	hrúbka kotúča	ks/bal	Obj. č.	MOC s DPH
--------	---------------	-------	---------------	--------	---------	-----------

### Rezné kotúče



Rezný kotúč na hliník – Rezný kotúč, lisovaný za studena, s pojivom zo syntetickej živice. Vhodný na rezanie hliníkových materiálov. Vysoký rezný výkon pri dlhej životnosti.

125	22,23		1	1	B-45331	1,99 €
150	22,23		1,6	1	B-45347	2,29 €
230	22,23		1,9	1	B-45369	3,99 €

2 v 1 rezný / brúsny kotúč na nerez a železo, vhodný pre akumulátorové brúsky

115	22,23		2	1	B-50360	1,99 €
-----	-------	--	---	---	---------	--------

Multi rezný kotúč na kov, nerez, PVC, obkladačky, tehly, betón

125	22,23		1,2	1	E-10724	2,19 €
-----	-------	--	-----	---	---------	--------

### Brúsny kotúč na oceľ a nehrdzavejúcu oceľ



Brúsne kotúče Makita sú stredne tvrdé univerzálne kotúče, určené pre všetky oblasti opracovania kovov. Brúsne kotúče majú hrubú zrnitosť a používajú sa na miestach, kde sa požaduje vysoký úberový výkon. Vzhľad výbrusu je zodpovedajúco hrubý.

Oblasť využitia: začisťovanie zvarov; brúsenie liatinových odliatkov; brúsenie hrán a plôch; brúsenie rohových zvarov; brúsenie bodových zvarov; zahladzovanie a výbrus okovín.

115	22,23		6	1	A-80640	1,89 €
125	22,23		4	1	B-53110	2,79 €
125	22,23		6	1	A-80656	2,49 €
150	22,23		6	1	A-80846	2,89 €
180	22,23		6	1	A-80880	4,19 €
230	22,23		6	1	A-80896	6,49 €
115	22,23		6	1	B-14560	2,29 €

### Brúsny kotúč na kov



Stredne tvrdý, univerzálny brúsny kotúč na celkové opracovanie normálnej ocele, napr. na odstraňovanie okovín, brúsenie hrán a výbrus plôch.

Mimoriadnou prednosťou tohto kotúča je optimálny pomer ceny a výkonu.

115	22,23		6	1	D-18459	1,39 €
115	22,23		6	1	A-80927	1,49 €
125	22,23		6	1	A-80933	1,79 €
150	22,23		6	1	A-84981	2,39 €
180	22,23		6	1	A-80949	2,69 €
230	22,23		6	1	A-80955	4,79 €

### Brúsny kotúč HEAVY DUTY na kov, železo a nerez



Univerzálny, stredne tvrdý brúsny kotúč, lisovaný za studena, s pojivom zo syntetickej živice, na celkové opracovanie ocele, napr. na odstraňovanie okovín, brúsenie hrán a výbrus plôch.

Mimoriadnou prednosťou tohto kotúča je vysoký úberový výkon pri optimálnej životnosti.

115	22,23		6	1	B-21113	1,29 €
125	22,23		6	1	B-21129	1,79 €
180	22,23		6	1	B-21135	2,89 €
230	22,23		6	1	B-21141	4,49 €

## Brúsny kotúč



## Štruktúra

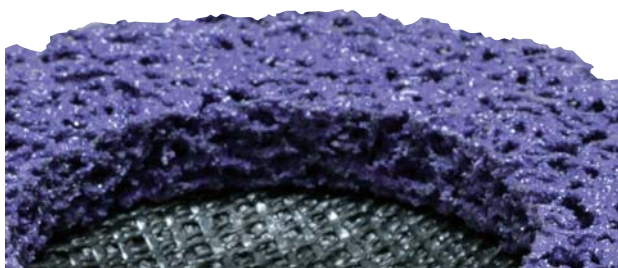

### Špeciálny kotúč na odstraňovanie farieb

#### Grit (SiC)

Štruktúra kotúča SiC (karbid kremíka) a vlákna umožňujú rýchle a zároveň šetrné brúsenie materiálu bez väčšej námahy.

#### Fiber

Zapuzdrené vlákna pôsobia šetrne na materiál a zabráňujú prílišnému odbrúseniu a poškrabaniu ocele.

## Vlastnosti

Rozdiel pri použití na rovnakom materiáli.



špeciálny kotúč

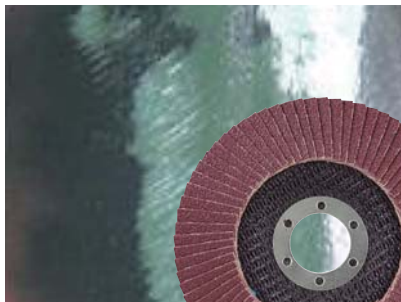

lamelový kotúč



brúsny kotúč

## Použitie



\*odstraňovanie farby



\*odstraňovanie hrdze



\*odstraňovanie farebných defektov po zvaroch



## Lamelové kotúče



### Typ uchytenia



**podložka zo sklenených vlákien**

štandardný typ podkladu



**nylonová podložka**

For heavy duty

### Tvar kotúča



**plochý**

pre rovné povrchy



**zaoblený**

použitie pri uhloch a rohoch

AA : odporúčané

A : prijateľný

zloženie brusiva	Aluminum oxide	Zirconia alumina	Silicon carbide	Ceramic aluminum oxide
popis a farba štítka	určený na železo	určený na železo a nerez	určený na murivo	určený na železo, nerez a neželezné kovy
drevo	A			
PVC	A			
železo	AA	AA		AA
neželezné kovy	A	A		AA
nerez		AA		AA
murivo			AA	

ø (mm)

ø otvoru (mm)

zrornosť

max. otáčky

ks/bal

Obj. č.

MOC s DPH

### Lamelový brúsny kotúč na ušľachtilú oceľ „Zirkón“

\*\*\*

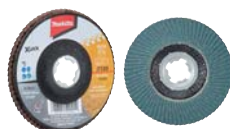

Brúsne zrnó zirkónového korundu je vhodné najmä na agresívny výbrus a vysoké namáhanie a je preto optimálne ako na hrubý úber, tak aj na finálny výbrus a leštenie tvrdej ocele. Vhodný materiál: ušľachtilá oceľ; neželezné kovy a ich zliatiny; rôzne stavebné ocele; hliník; drevo; liatina.

125	X-LOCK	40	12.500	1	D-76009	7,39 €
125	X-LOCK	60	12.500	1	D-76015	6,49 €
125	X-LOCK	80	12.500	1	D-76021	6,89 €
125	X-LOCK	120	12.500	1	D-76037	6,89 €

## BRÚSENIE: LAMELOVÉ KOTUČE

	ø (mm)	ø otvoru (mm)	zrornosť	max. otáčiky	ks/bal	Obj. č.	MOC s DPH
<b>Lamelové brúsne kotúče na ocel „Korund“</b>							*****
 <p>Brúsne zrno z korundu je vhodné najmä na brúsenie mäkkej ocele. Lamelové brúsne kotúče sú optimálne ako na hrubý výbrus, tak aj na finálny výbrus a leštenie. Brúsne listy kotúča majú vejárovité usporiadanie, navzájom sa prekrývajú a sú upevnené na vysokokvalitnom kotúči s vláknami zo sklolaminátu. Najdôležitejšie prednosti lamelových brúsnych kotúčov: vysoký a konštantný úberový výkon, studený výbrus; vysoká kvalita výbrusu; dlhá životnosť; nízka hlučnosť. Oblasti využitia: odhrdzovanie; výbrus odliatok; znášanie hrán; výbrus plôch; odstraňovanie farieb/tmelov; finálny výbrus. Vhodný materiál: hliník; mäkké neželezné kovy a ich zliatiny; rôzne stavebné ocele; plasty; drevo; liatina.</p>	115	22,23	40	13 300	1	P-65137	3,59 €
	115	22,23	60	13 300	1	P-65143	3,79 €
	115	22,23	80	13 300	1	P-65159	3,39 €
	115	22,23	120	13 300	1	P-65165	2,99 €
	125	22,23	40	12 000	1	P-65171	4,19 €
	125	22,23	60	12 000	1	P-65187	4,09 €
	125	22,23	80	12 000	1	P-65193	4,09 €
	125	22,23	120	12 000	1	P-65202	4,09 €
	150	22,23	40	10 200	1	P-65218	5,89 €
	150	22,23	60	10 200	1	P-65224	6,09 €
	150	22,23	80	10 200	1	P-65230	5,89 €
	180	22,23	40	8 600	1	P-65252	8,29 €
	180	22,23	60	8 600	1	P-65268	7,49 €
	180	22,23	80	8 600	1	P-65274	7,59 €

	ø (mm)	ø otvoru (mm)	zrornosť	max. otáčiky	ks/bal	Obj. č.	MOC s DPH
<b>Lamelový brúsny kotúč na ušľachtilú ocel „Zirkón“</b>							*****
 <p>Brúsne zrno zo zirkónového korundu je vhodné najmä na agresívny výbrus a vysoké namáhanie a je preto optimálne ako na hrubý úber, tak aj na finálny výbrus a leštenie tvrdej ocele. Brúsne listy kotúča majú vejárovité usporiadanie, navzájom sa prekrývajú a sú upevnené na vysokokvalitnom kotúči s vláknami zo sklolaminátu. Najdôležitejšie prednosti lamelových brúsnych kotúčov: mimoriadne vysoký a konštantný úberový výkon; vysoká kvalita povrchu; dlhá životnosť; nízka hlučnosť. Oblasti využitia: odstraňovanie okovín; výbrus odliatok; znášanie hrán; výbrus plôch; odstraňovanie hrdze/tmelov; finálny výbrus. Vhodný materiál: ušľachtilá ocel; neželezné kovy a ich zliatiny; rôzne stavebné ocele; hliník; drevo; liatina.</p>	115	22,23	40	13 300	1	P-65458	3,59 €
	115	22,23	60	13 300	1	P-65464	3,69 €
	115	22,23	80	13 300	1	P-65470	3,59 €
	115	22,23	120	13 300	1	P-65486	3,59 €
	125	22,23	40	12 000	1	P-65492	3,99 €
	125	22,23	60	12 000	1	P-65501	3,99 €
	125	22,23	80	12 000	1	P-65517	3,89 €
	125	22,23	120	12 000	1	P-65523	3,79 €
	150	22,23	40	10 200	1	P-65539	5,29 €
	150	22,23	60	10 200	1	P-65545	5,29 €
	150	22,23	80	10 200	1	P-65551	5,09 €
	150	22,23	120	10 200	1	P-65567	5,29 €
	180	22,23	40	8 600	1	P-65573	7,19 €
	180	22,23	60	8 600	1	P-65589	8,59 €
	180	22,23	80	8 600	1	P-65595	7,09 €
180	22,23	120	8 600	1	P-65604	7,19 €	

	ø (mm)	ø otvoru (mm)	zrornosť	max. otáčiky	ks/bal	Obj. č.	MOC s DPH
<b>Lamelové brúsne kotúče na kameň</b>							*****
 <p>Brúsne zrno z karbidu kremíka má tvrdú štruktúru s ostrými hranami a je vhodné najmä na brúsenie tvrdých a húževnatých materiálov s nízkou pevnosťou v ťahu. Brúsne listy kotúča majú vejárovité usporiadanie, navzájom sa prekrývajú a sú upevnené na vysokokvalitnom kotúči s vláknami zo sklolaminátu. Najdôležitejšie prednosti lamelových brúsnych kotúčov: vysoký a konštantný úberový výkon, studený výbrus; vysoká kvalita povrchu; dlhá životnosť; nízka hlučnosť. Oblasti využitia: znášanie hrán; výbrus plôch; brúsenie hrán; finálny výbrus. Vhodný materiál: kameň; sklo; keramika; plasty.</p>	115	22,23	40	13 300	1	P-65296	2,79 €
	115	22,23	60	13 300	1	P-65305	2,79 €
	115	22,23	80	13 300	1	P-65311	2,79 €
	115	22,23	120	13 300	1	P-65327	2,79 €
	125	22,23	40	12 000	1	P-65333	4,09 €
	125	22,23	60	12 000	1	P-65349	3,79 €
	125	22,23	80	12 000	1	P-65355	4,39 €
	125	22,23	120	12 000	1	P-65361	4,29 €
	150	22,23	40	10 200	1	P-65377	4,89 €
	180	22,23	40	8 600	1	P-65414	6,99 €

## BRÚSENIE: LAMELOVÉ KOTUČE

ø (mm)	ø otvoru (mm)	zrmitosť	max. otáčky	ks/bal	Obj. č.	MOC s DPH
--------	---------------	----------	-------------	--------	---------	-----------

### Lamelové brúsne kotúče na kov



Lamely brúsneho kotúča sú vyrobené z Aluminium oxidu určené na brúsenie kovov, neferozných kovov, PVC a dreva

Podložka zo sklenených vlákien, tvar kotúča zaoblený.



115	22,23	40	13 300	10	D-63432-10	13,99 €
115	22,23	60	13 300	10	D-63448-10	12,99 €
115	22,23	80	13 300	10	D-63454-10	13,99 €
115	22,23	120	13 300	10	D-63460-10	11,99 €
125	22,23	40	12 000	10	D-63476-10	14,99 €
125	22,23	60	12 000	10	D-63482-10	14,99 €
125	22,23	80	12 000	10	D-63498-10	14,99 €
125	22,23	120	12 000	10	D-63507-10	14,99 €

### Lamelové brúsne kotúče na kov



Lamely brúsneho kotúča sú vyrobené zo Zirkon aluminium určené na brúsenie kovov, neferozných kovov a nerez

Podložka zo sklenených vlákien, tvar kotúča zaoblený.



115	22,23	40	13 300	10	D-63747-10	19,99 €
115	22,23	60	13 300	10	D-63753-10	16,99 €
115	22,23	80	13 300	10	D-63769-10	15,99 €
115	22,23	120	13 300	10	D-63775-10	15,99 €
125	22,23	40	12 000	10	D-63781-10	22,99 €
125	22,23	60	12 000	10	D-63797-10	21,99 €
125	22,23	80	12 000	10	D-63806-10	20,99 €
125	22,23	120	12 000	10	D-63812-10	20,99 €

### Lamelové brúsne kotúče na nerez



Lamely brúsneho kotúča sú vyrobené zo Zirkon aluminium určené na brúsenie kovov, neferozných kovov a nerez

Podložka zo sklenených vlákien, tvar kotúča zaoblený.



125	22,23	40	12200	1	B-53920	7,29 €
125	22,23	60	12200	1	B-53936	8,39 €
125	22,23	80	12200	1	B-53942	6,89 €
115	22,23	40	13.300	1	D-74186	2,19 €
115	22,23	60	13.300	1	D-74192	2,19 €
115	22,23	80	13.300	1	D-74201	1,79 €
115	22,23	120	13.300	1	D-74217	2,09 €
125	22,23	40	13.300	1	D-74223	2,29 €
125	22,23	60	13.300	1	D-74239	2,39 €
125	22,23	80	13.300	1	D-74245	2,39 €
125	22,23	120	13.300	1	D-74251	2,29 €

### Brúsný kotúč na odstraňovanie farby



Špeciálne brúsne kotúče určené na odstraňovanie farby a hrdze, vďaka zapleteným vláknam, vyrobených z karbidu hliníka, ktoré umožňujú rýchle brúsenie s menším odporom a slúžia ako poduška, ktorá zabraňuje nadmernému brúseniu a poškrabaniu obrobku. Výborne sa prispôbujú aj nerovnému opracovanému povrchu.

Vhodný materiál: nerez, železo, neferozné kovy.



ø (mm)	ø otvoru (mm)	popis/farba kotúča	max. otáčky	bal/ks	obj. č.	MOC s DPH
115	22,23	štandard / čierna	12 000	1	B-28977	11,99 €
125	22,23	štandard / čierna	12 000	1	B-28983	12,99 €
115	22,23	Longlife / fialová	12 000	1	B-29016	12,99 €
125	22,23	Longlife / fialová	12 000	1	B-29022	14,99 €

## DELENIE: BRÚSNE KOTÚČE

ø (mm)	ø otvoru (mm)	zmitosť	ks/bal	Obj. č.	MOC s DPH
--------	---------------	---------	--------	---------	-----------

### Fíbový brúsny list „Korund“



Brúsny list so zrnom z korundu, upevneným na fíbovej podložke pomocou pojiva zo syntetickej živice. Podložka je vyrobená z mimoriadne pevnej tkaniny zo sklenených vlákien. Používa sa s elastickým brúsnym tanierom. Oblasti využitia: odhrdzovanie a čistenie kovových povrchov; výbrus starých lakov a podkladových vrstiev; zarovnávanie zvarov a zahladzovanie, výbrus hrán; odstraňovanie okovín a výbrus nádrží a prístrojov

115	13	36	5	P-00876	4,69 €
115	13	40	5	P-00882	4,39 €
115	13	60	5	P-00907	4,69 €
115	13	100	5	P-00929	4,39 €
125	13	24	5	P-00957	5,69 €
125	13	36	5	P-00963	5,59 €
125	13	40	5	P-00979	5,69 €
125	13	60	5	P-00985	5,59 €
125	13	80	5	P-00991	5,59 €
125	13	100	5	P-01002	5,39 €
180	13	16	5	P-01024	7,79 €
180	13	24	5	P-01030	7,39 €
180	13	36	5	P-01046	6,79 €
180	13	40	5	P-01052	6,99 €
180	13	60	5	P-01074	6,79 €
180	13	80	5	P-01080	7,39 €
180	13	100	5	P-01096	7,39 €

### Brúsny papier 180 mm, neperforovaný k brúsnemu kotúču 743053-3

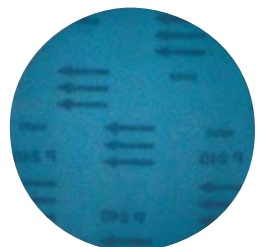

Vhodné pre farebné kovy, plasty, drevo, drevo s klincami, kov, kameň.

ø (mm)	popis	zmitosť	bal/ks	obj. č.	MOC s DPH
180	suchý zip	80	10	P-33445	8,29 €
180	suchý zip	120	10	P-33451	7,49 €
180	suchý zip	240	10	P-38059	7,39 €
180	suchý zip	400	10	P-38087	7,39 €

### Gumové taniere



ø (mm)	bal/ks	obj. č.	MOC s DPH
115	1	P-05882	4,49 €
125	1	P-05898	4,89 €
150	1	P-05907	8,29 €
180	1	P-05913	7,29 €

# PRÍSLUŠENSTVO

## Multi Tool



Karbid z volfrámu, #30



Karbid z volfrámu, #30



Diamantové zrno, #40



Zúbkovaná hrana



Ostrá hrana



Ostrá hrana



Delta doska



Brúsna doska

# Príslušenstvo

## Multi Tool

# STARLOCK



Vhodné pre aplikácie  
✓ = vhodné

Farebné rozlíšenie  
pre aplikácie



drevo a kov



drevo



kov



Multi Material



škárovacia hmota

šírka (mm)	počet zubov na palec	materiál	zakrivené zuby
------------	----------------------	----------	----------------

TMA045	85	18	BiM	
TMA046	100	15	BiM	
TMA047	32	20	BiM	●
TMA048	65	20	BiM	●
TMA057	10	20	BiM	
TMA058	20	20	BiM	
TMA049	85	18	HCS	
TMA050	24	18	HCS	
TMA051	32	18	HCS	●
TMA052	65	20	HCS	●
TMA053	32	14	BiM	●
TMA054	32	14	HCS	●
TMA055	65	14	BiM	●
TMA056	65	14	HCS	●
TMA059	32	20	BiM	
TMA060	20	23	TC	
TMA061	32	23	TC	
TMA079	45	23	TC	
TMA063	100	-	BiM	
TMA064	85	18	BiM	
TMA065	52	-	HCS	
TMA066	52	-	HCS	
TMA067	28	-	HCS	
TMA068	11	-	HCS	
TMA080	32	20	TC	●
TMA081	53	14	BiM	●
TMA082	12	-	Stainless	
TMA069	85	-	TC #30	
TMA070	85	-	Diamond	
TMA071	70	-	TC #50	
TMA072	85	-	TC #40	
TMA073	78	-	TC #20	
TMA074	70	-	TC #40	
TMA075	32	-	TC #50	
TMA076	32	-	TC #40	
TMA077	32	-	TC #100	
TMA083	90	-	TC #20	
TMA084	90	-	TC #40	
TMA085	90	-	TC #60	
TMA086	90	-	TC #100	

drevo a kov									
drevo					kov				
drevo	preglejka	drevotrieska	laminát	sadrokartón	neželezné kovy	plechy	nerez	mäkky klinec	
✓	✓	✓	✓	✓	✓	✓		✓	
✓	✓	✓	✓	✓	✓			✓	
✓	✓	✓	✓	✓	✓	✓		✓	
✓	✓	✓	✓	✓	✓	✓		✓	
✓	✓	✓	✓	✓	✓	✓		✓	
✓	✓	✓	✓						
✓	✓	✓	✓						
✓	✓	✓	✓	✓					
✓	✓	✓	✓	✓					
✓	✓	✓	✓	✓	✓	✓		✓	
✓	✓	✓	✓	✓	✓	✓	✓	✓	
✓	✓	✓	✓	✓	✓	✓	✓	✓	
✓	✓	✓	✓	✓	✓	✓		✓	
✓	✓	✓	✓	✓	✓	✓	✓	✓	
✓	✓	✓	✓	✓	✓	✓	✓	✓	
✓									
✓									
✓	✓								
✓	✓								
✓	✓	✓							
✓	✓	✓							
✓									



Multi Material						škárovacia hmota			
epoxydy	sklolaminát	linoleum	lepidlo na koberce	izolačný materiál	mäkký spojovací materiál	porézny betón, mäkká tehla	mäkké obklady stien	malta, lepidlo na dlaždice	
✓	✓								
✓	✓								
✓	✓								
✓	✓								
✓	✓								
✓	✓								
✓									
✓									
✓									
✓	✓								
✓	✓								
✓	✓								
✓	✓								
✓	✓								
		✓	✓	✓					
✓	✓								
			✓						
			✓						
					✓				
		✓	✓	✓					
✓	✓								
✓					✓				
✓	✓					✓	✓	✓	
✓	✓					✓	✓	✓	
✓	✓					✓	✓	✓	
✓	✓					✓	✓	✓	
✓	✓					✓	✓	✓	
✓	✓					✓	✓	✓	
✓	✓					✓	✓	✓	
								✓	
	✓							✓	
	✓							✓	
								✓	
								✓	

zakřivené zuby	materiál	počet zubov na palec	šírka (mm)	
	BiM	18	85	TMA045
	BiM	15	100	TMA046
●	BiM	20	32	TMA047
●	BiM	20	65	TMA048
	BiM	20	10	TMA057
	BiM	20	20	TMA058
	HCS	18	85	TMA049
	HCS	18	24	TMA050
●	HCS	18	32	TMA051
●	HCS	20	65	TMA052
●	BiM	14	32	TMA053
●	HCS	14	32	TMA054
●	BiM	14	65	TMA055
●	HCS	14	65	TMA056
	BiM	20	32	TMA059
	TC	23	20	TMA060
	TC	23	32	TMA061
	TC	23	45	TMA079
	BiM	-	100	TMA063
	BiM	18	85	TMA064
	HCS	-	52	TMA065
	HCS	-	52	TMA066
	HCS	-	28	TMA067
	HCS	-	11	TMA068
●	TC	20	32	TMA080
●	BiM	14	53	TMA081
	Stainless	-	12	TMA082
	TC #30	-	85	TMA069
	Diamond	-	85	TMA070
	TC #50	-	70	TMA071
	TC #40	-	85	TMA072
	TC #20	-	78	TMA073
	TC #40	-	70	TMA074
	TC #50	-	32	TMA075
	TC #40	-	32	TMA076
	TC #100	-	32	TMA077
	TC #20	-	90	TMA083
	TC #40	-	90	TMA084
	TC #60	-	90	TMA085
	TC #100	-	90	TMA086

Farebné rozlíšenie pre aplikácie



drevo a kov



drevo



kov



Multi Material



škárovacia hmota

Akumulátory  
 Odkladacie systémy  
 Vŕtanie  
 Skrútkovanie  
 Brúsky  
 Pílenie  
 Frézovanie  
 Brúsenie  
 Klince / spony  
 Špeciálne stroje  
 Vysávanie  
 Fény/lampy  
 Záhrada  
 Ručné náradie  
 Ostatné

# Príslušenstvo

## Multi Tool

### STARLOCK PLUS STARLOCK MAX



Vhodné pre aplikácie  
✓ = vhodné

Farebné rozlíšenie pre aplikácie

šírka (mm)	počet zubov na palec	materiál	zakrivené zuby
------------	----------------------	----------	----------------

drevo a kov									
drevo					kov				
drevo	preglejka	drevotrieska	laminát	sadrokartón	neželezné kovy	plechy	nerez	mäkky klinec	

### STARLOCK PLUS



drevo a kov

MAP001	32	20	BiM	●
MAP002	65	20	BiM	●

✓	✓	✓	✓	✓	✓	✓		✓	
✓	✓	✓	✓	✓	✓	✓		✓	



drevo

MAP003	32	18	HCS	●
--------	----	----	-----	---

✓	✓	✓	✓						
---	---	---	---	--	--	--	--	--	--



kov

MAP004	32	23	TC	
MAP005	45	23	TC	

✓	✓	✓	✓	✓	✓	✓	✓	✓	✓
✓	✓	✓	✓	✓	✓	✓	✓	✓	✓



Multi Material

MAP006	32	20	TC	●
MAP007	52	20	TC	●

✓	✓	✓	✓	✓	✓	✓	✓	✓	✓
✓	✓	✓	✓	✓	✓	✓	✓	✓	✓



škárovacia hmota

MAP008	53	-	TC #40	
--------	----	---	--------	--

✓		✓		✓	✓				✓
---	--	---	--	---	---	--	--	--	---

### STARLOCK MAX



drevo a kov

MAM001	32	20	BiM	●
MAM002	52	18	BiM	●
MAM003	100	15	BiM	

✓	✓	✓	✓	✓	✓	✓		✓	
✓	✓	✓	✓	✓	✓	✓		✓	
✓	✓	✓	✓		✓				✓



drevo

MAM004	32	18	HCS	●
--------	----	----	-----	---

✓	✓	✓	✓						
---	---	---	---	--	--	--	--	--	--



kov

MAM005	32	23	TC	
--------	----	----	----	--

✓	✓	✓	✓	✓	✓	✓	✓	✓	✓
---	---	---	---	---	---	---	---	---	---



Multi Material

MAM006	32	20	TC	●
MAM007	32	-	HCS	
MAM008	32	-	HCS	

✓	✓	✓	✓	✓	✓	✓	✓	✓	✓

MAM009	68	-	TC #50	
MAM010	68	-	TC #30	
MAM011	68	-	Diamond	
MAM012	68	-	Diamond	
MAM013	68	-	TC #40	
MAM014	100	-	TC #40	
MAM015	116	-	TC #20	
MAM016	116	-	TC #40	
MAM017	116	-	TC #60	
MAM018	116	-	TC #100	

				✓					
				✓					
				✓					
				✓					
				✓					
✓	✓			✓	✓				✓
✓	✓	✓							
✓	✓	✓							
✓	✓	✓							



škárovacia hmota

MAM013	68	-	TC #40	
MAM014	100	-	TC #40	
MAM015	116	-	TC #20	
MAM016	116	-	TC #40	
MAM017	116	-	TC #60	
MAM018	116	-	TC #100	

				✓					
				✓					
				✓					
				✓					
✓	✓			✓	✓				✓





Multi Material						škárovacia hmota		
epoxydy	sklolaminát	linoleum	lepidlo na koberce	izolačný materiál	mäkký spojovací materiál	porézny betón, mäkká tehla	mäkké obklady stien	malta, lepidlo na dlaždice

zakřivené zuby	materiál	počet zubov na palec	šírka (mm)	
----------------	----------	----------------------	------------	--

Farebné rozlíšenie pre aplikácie

✓	✓							
✓	✓							

●	BiM	20	32	MAP001
●	BiM	20	65	MAP002



✓								
---	--	--	--	--	--	--	--	--

●	HCS	18	32	MAP003
---	-----	----	----	--------



✓	✓					✓		
✓	✓							

	TC	23	32	MAP004
	TC	23	45	MAP005



✓	✓					✓		
✓	✓					✓		

●	TC	20	32	MAP006
●	TC	20	52	MAP007



✓						✓		
---	--	--	--	--	--	---	--	--

	TC #40	-	53	MAP008
--	--------	---	----	--------

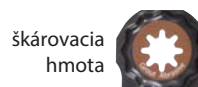

✓	✓							
✓	✓							
✓								

●	BiM	20	32	MAM001
●	BiM	18	52	MAM002
	BiM	15	100	MAM003



--	--	--	--	--	--	--	--	--

●	HCS	18	32	MAM004
---	-----	----	----	--------



✓	✓					✓		
---	---	--	--	--	--	---	--	--

	TC	23	32	MAM005
--	----	----	----	--------



✓	✓					✓		
						✓		
				✓	✓			
				✓	✓			

●	TC	20	32	MAM006
	HCS	-	32	MAM007
	HCS	-	32	MAM008



✓	✓					✓	✓	✓
✓	✓					✓	✓	✓
✓	✓					✓	✓	✓
✓	✓					✓	✓	✓
✓	✓					✓	✓	✓
	✓							✓
	✓							✓
								✓
								✓

	TC #50	-	68	MAM009
	TC #30	-	68	MAM010
	Diamond	-	68	MAM011
	Diamond	-	68	MAM012
	TC #40	-	68	MAM013
	TC #40	-	100	MAM014
	TC #20	-	116	MAM015
	TC #40	-	116	MAM016
	TC #60	-	116	MAM017
	TC #100	-	116	MAM018



# DELENIE: PRÍSLUŠENSTVO PRE MULTITOOL



Compatibility with models	Blade Shank		
	STARLOCK	STARLOCK PLUS	STARLOCK MAX
<b>OIS Compatible Tools</b>	✓	-	-
<b>STARLOCK MAX</b>	✓	✓	✓

ø (mm)	materiál	TPI/ zrnitosť	použitie	označenie	Obj. č.	MOC s DPH
--------	----------	------------------	----------	-----------	---------	-----------

## Pílvy kotúč



85	HCS	18	drevo	TMA049	B-64836	14,99 €
100	BiM	15	drevo / kov	TMA046	B-64808	23,99 €
85	BiM	18	drevo / kov	TMA045	B-64799	18,99 €
85	BiM-TiN	18	multi	TMA064	B-64973	23,99 €

## Segmentový pílový kotúč s tvrdokovom



85	HM/RIFF	30	rezanie špár	TMA069	B-65028	26,99 €
85	DIA	40	rezanie špár, kachličiek a FRP	TMA070	B-65034	44,99 €
65	HM/TC	50	rezanie tenkých špár (1,6 mm)	TMA071	B-65040	22,99 €
32 x 30	HM/TC	50	fibrové sklo, malta	TMA075	B-65084	22,99 €

## Nástroje na odstraňovanie vrstiev materiálu



52 x 26	HCS		odstraňovanie malty, lepidla	TMA065	B-64989	8,19 €
52 x 45	HCS		odstraňovanie lepidiel a silikónu	TMA066	B-64995	8,19 €
28 x 40	HCS		tmel silikón	TMA067	B-65006	15,99 €
12 x 29	HCS		tmel silikón	TMA082	B-69783	18,99 €

## Rezné nástroje





11 x 24	HCS		koberce, lino	TMA068	B-65012	18,99 €
100	BiM		polystyrén, guma, izol. materiál	TMA063	B-64967	24,99 €
32 x 50	BiM	20	kov	TMA059	B-64939	11,99 €
20 x 30	BiM	20	kov	TMA058	B-64923	8,19 €
10 x 30	BiM	20	kov	TMA057	B-64917	8,09 €
65 x 40	HCS	20	drevo	TMA052	B-64864	11,99 €
32 x 50	BiM	14	drevo	TMA053	B-64870	13,99 €
32 x 50	HCS	18	drevo	TMA51	B-64858	9,89 €
24 x 50	HCS	18	drevo	TMA050	B-64842	9,09 €
65 x 40	BiM	20	kov, drevo	TMA048	B-64820	15,99 €
32 x 50	BiM	20	kov, drevo	TMA047	B-64814	12,99 €
45	TC/HM	23	kov	TMA079	B-69755	21,99 €
32	TC/HM	20	multi	TMA080	B-69761	21,99 €
53	BiM	14	sadrokartón	TMA081	B-69777	13,99 €

# DELENIE: PRÍSLUŠENSTVO PRE MULTITOOL

	ø (mm)	materiál	TPV/ zrornosť	použitie	označenie	Obj. č.	MOC s DPH
<b>Odsávací adaptér pre multitool</b> <span style="float: right;">*****</span>							
					TM3000C	199618-3	8,09 €
					TM30D	199630-3	13,99 €
					TM3010C	199624-8	9,99 €
					DTM41,DTM51	199627-2	12,99 €
					DTM52	191R02-6	12,99 €

<b>Brúsny tanier</b> <span style="float: right;">*****</span>							
	78	TC/HM	20	malta, lepidlo na obklady	TMA073	B-65062	21,99 €
	90	TC/HM	20	malta, lepidlo na obklady	TMA083	B-69799	18,99 €
	990	TC/HM	40	malta, lepidlo na obklady	TMA84	B-69808	18,99 €
	90	TC/HM	60	malta, lepidlo na obklady	TMA085	B-69814	18,99 €
	90	TC/HM	100	malta, lepidlo na obklady	TMA086	B-69820	18,99 €

<b>Rezný a brúsny tanier</b> <span style="float: right;">*****</span>							
	70	TC/HM	44	malta, lepidlo na obklady	TMA074	B-65078	37,99 €

<b>Adaptér</b> <span style="float: right;">*****</span>							
	adaptér pre príslušenstvo Fein					196271-6	6,99 €

**Sady nástrojov** **B-67496** **62,99 €** (MOC s DPH)

B-64923 / B-64989 / B-65028 / B-65115  
4 ks/bal



**Sady nástrojov** **B-67480** **51,99 €** (MOC s DPH)

B-64799 / B-64814 / B-64870 / B-64923  
4 ks/bal



**Sady nástrojov** **B-67505** **50,99 €** (MOC s DPH)

B-64799 / B-64820 / B-64858 / B-64955  
4 ks/bal



**Sady nástrojov** **B-67511** **52,99 €** (MOC s DPH)

B-64799 / B-64814 / B-64870 / B-65115 x 2  
5 ks/bal



**Sada rezných nástrojov** **B-64842-5** **42,99 €** (MOC s DPH)

TMA050 24 x 50 mm, 5 ks/bal.  
vhodný na rezanie dreva







**Sada rezných nástrojov** **B-64870-5** **61,99 €** (MOC s DPH)

TMA053 35 x 50 mm, 5 ks/bal.  
vhodný na rezanie dreva

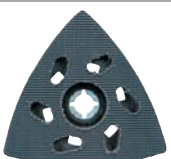

## DELENIE: PRÍSLUŠENSTVO PRE MULTITOOL

	rozmer (mm)	zrntosť	ks/bal.	Obj. č.	MOC s DPH
<b>Drevo / Long Life</b> <span style="float: right;">*****</span>					
 <p>Vhodné na brúsenie dreva, tvrdého dreva, drevotriesky, stavebného dreva alebo kovu</p>	93	60	10	P-33261	3,19 €
	93	80	10	P-33277	3,09 €
	93	100	10	P-33283	2,99 €
	93	120	10	P-33299	2,99 €
	93	180	10	P-33314	2,99 €
	93	240	10	P-33320	2,99 €
	93	60, 80, 100, 120, 180 (2 ks z každého)	10	B-21559	3,09 €
<b>Farba</b> <span style="float: right;">*****</span>					
 <p>Vhodné na brúsenie farieb a lakov</p>	93	60	10	P-42690	3,19 €
	93	80	10	P-42709	3,09 €
	93	100	10	P-42715	2,89 €
	93	120	10	P-42721	2,99 €
	93	240	10	P-42759	2,69 €
	93	320	10	P-42765	2,89 €
	93	60,80,100,240,320 (2 ks z každého)	10	B-21674	2,99 €
<b>Kameň</b> <span style="float: right;">*****</span>					
 <p>Vhodné na hrubé obrúsenie extrémne tvrdých materiálov napríklad kameňa alebo skla</p>	93	120	10	B-21749	2,99 €
	93	240	10	B-21755	2,79 €
	93	400	10	B-21761	2,69 €
	93	600	10	B-21777	2,69 €
	93	1200	10	B-21783	2,69 €
	93	120, 240, 400, 600, 1200 (2 ks z každého)	10	B-21733	2,89 €
<b>Fleece</b> <span style="float: right;">*****</span>					
 <p>Vhodné na obrusovanie hrdzavých plôch alebo nečistôt z dreva</p>	93	100	1	B-21799	1,69 €
	93	280	1	B-21808	1,59 €
	93	bez brusiva	1	B-21814	1,59 €
<b>Leštenie</b> <span style="float: right;">*****</span>					
 <p>Vhodné na leštenie veľmi nečistých alebo poškrábaných povrchov.</p>	93	tvrdý	1	B-21820	1,89 €
<b>Držiak brúsneho papiera</b> <span style="float: right;">*****</span>					
	suchý zip	TMA078	1	B-65115	11,99 €

**Rezanie (ponorné rezanie)**



**Pílenie**



**Brúsenie**

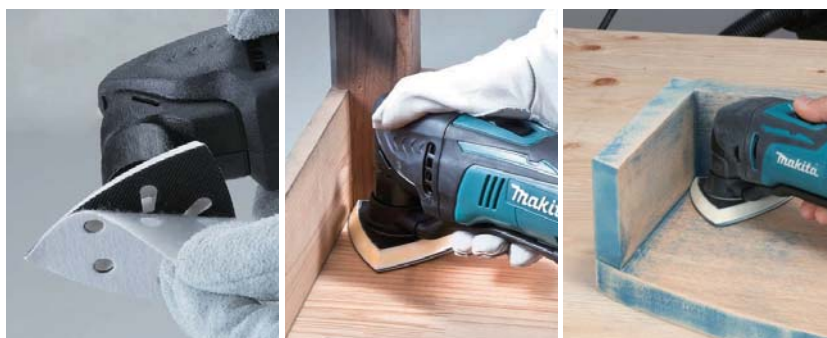
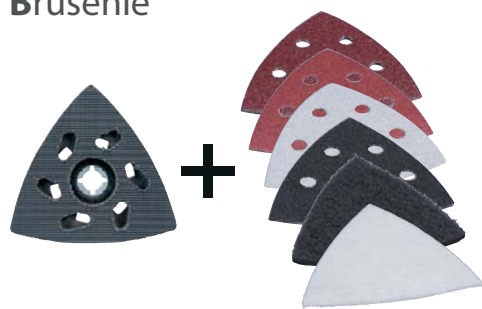

**Odstraňovanie škárovacej hmoty a rezanie dlaždíc**

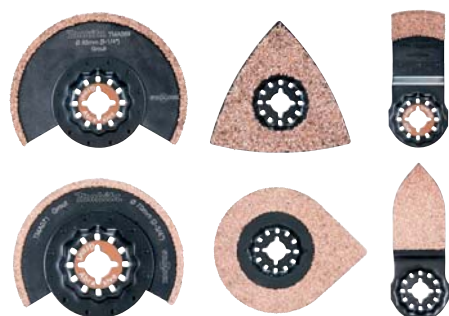

**Škrabanie**



# STARLOCK PLUS

Kompatibilné s modelmi		typ upnutia		
		STARLOCK	STARLOCK PLUS	STARLOCK MAX
typ upnutia	OIS kompatibilné stroje	✓	-	-
	STARLOCK MAX	✓	✓	✓

## Vhodné najmä na drevo a kov

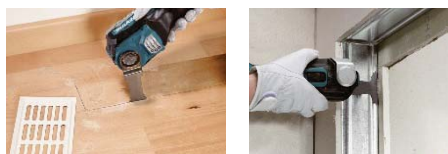

## Ponorný pilový list v tvare oblúka 32

MAP001

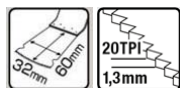

Použitie: Vhodné pre presný ponorný rez, hlboký rez  
Vhodné aj pre: epoxid, sklolaminát

rozmer (mm)	typ	ks/bal.	obj. č.	MOC s DPH
32 x 60	BiM, drevo a kov	1	B-66329	13,99 €

## Ponorný pilový list v tvare oblúka 65

MAP002

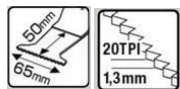

Použitie: Vhodné pre presný ponorný rez, hlboký rez  
Ďalší materiál: epoxid, sklolaminát

rozmer (mm)	typ	ks/bal.	obj. č.	MOC s DPH
65 x 50	BiM, drevo a kov	1	B-66335	16,99 €

## Vhodné najmä na drevo



## Ponorný pilový list v tvare oblúka 32

MAP003

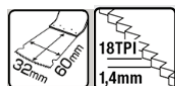

Použitie: Vhodné pre presný ponorný rez, hlboký rez  
Vhodné aj pre: epoxid

rozmer (mm)	typ	ks/bal.	obj. č.	MOC s DPH
32 x 60	HCS, drevo	1	B-66341	10,09 €

## Vhodné najmä na kovy



## TC ponorný pilový list 32

MAP004



Použitie: Vhodné pre ponorný rez, hlboký rez  
Vhodné aj pre: drevené materiály, epoxid, sklolaminát

rozmer (mm)	typ	ks/bal.	obj. č.	MOC s DPH
32 x 50	TC/HM, Metal	1	B-66357	22,99 €

## TC ponorný pilový list 45

MAP005

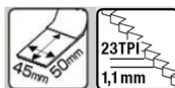

Použitie: Vhodné pre ponorný rez, hlboký rez  
Vhodné aj pre: drevené materiály, epoxid, sklolaminát

rozmer (mm)	typ	ks/bal.	obj. č.	MOC s DPH
45 x 50	TC/HM, Metal	1	B-66363	24,99 €

## Vhodné najmä pre MultiMaterial



## TC ponorný pilový list v tvare oblúka 32

MAP006



Použitie: Vhodné pre ponorný rez, hlboký rez  
Vhodné aj pre: drevené materiály, sádrokartón, nežeľezné kovy, plech, nerez, mäkký klinec

rozmer (mm)	typ	ks/bal.	obj. č.	MOC s DPH
32 x 50	TC/HM, Multi Material	1	B-66379	24,99 €

## TC ponorný pilový list v tvare oblúka 52

MAP007



Použitie: Vhodné pre ponorný rez, hlboký rez  
Vhodné aj pre: drevené materiály, sádrokartón, nežeľezné kovy, plech, nerez, mäkký klinec

rozmer (mm)	typ	ks/bal.	obj. č.	MOC s DPH
52 x 50	TC/HM, Multi Material	1	B-66385	25,99 €

## Vhodné najmä pre škárovacie hmoty



### Ponorný pílový list v tvare oblúka 53

MAM008



Použitie: Vhodné pre presný a rýchly ponorný rez  
Vhodné aj pre: drevené materiály, sádkokartón, neželezné kovy, mäkký kliniec, epoxid, 1 nóż 2 práce (zápich a rezanie)

rozmer (mm)	typ	ks/bal.	obj. č.	MOC s DPH
53 x 40	TC/HM zrnitc	1	B-66391	18,99 €

## STARLOCK MAX

Kompatibilné s modelmi	typ upnutia		
	STARLOCK	STARLOCK PLUS	STARLOCK MAX
typ upnutia			
OIS kompatibilné stroje	✓	-	-
<b>STARLOCK MAX</b>	✓	✓	✓

## Vhodné najmä na drevo a kov



### Ponorný pílový list v tvare oblúka 32

MAM001

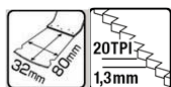

Použitie: Vhodné pre presný ponorný rez, hlboký rez  
Vhodné aj pre: epoxid, sklolaminát

rozmer (mm)	typ	ks/bal.	obj. č.	MOC s DPH
32 x 80	BiM, drevo a	1	B-66400	13,99 €

### Ponorný pílový list v tvare oblúka 52

MAM002

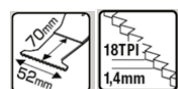

Použitie: Vhodné pre presný ponorný rez, hlboký rez  
Vhodné aj pre: epoxid, sklolaminát

rozmer (mm)	typ	ks/bal.	obj. č.	MOC s DPH
52 x 70	BiM, drevo a	1	B-66416	14,99 €

### Segmentový pílový kotúč 100

MAM003



Použitie: Vhodné pre rovné dlhé rezy, hlboké a široké rezy  
Vhodné aj pre: epoxid, sklolaminát

rozmer (mm)	typ	ks/bal.	obj. č.	MOC s DPH
100	BiM, drevo a	1	B-66422	23,99 €

## Vhodné najmä na drevo



### Ponorný pílový list v tvare oblúka 32

MAM004



Použitie: Vhodné pre presné zapichovacie rezy, hlboké a rýchle rezy  
Vhodné len pre drevo

rozmer (mm)	typ	ks/bal.	obj. č.	MOC s DPH
32 x 80	HCS, dre	1	B-66438	10,99 €

## Vhodné najmä na kovy



### TC ponorný pílový list 32

MAM005



Použitie: Vhodné pre ponorné, hlboké a rýchle rezy  
Vhodné aj pre: epoxid, sklolaminát, drevené materiály, pórobeton

rozmer (mm)	typ	ks/bal.	obj. č.	MOC s DPH
32 x 70	TC/HM, ko	1	B-66444	23,99 €

## Vhodné najmä pre MultiMaterial



### TC ponorný pílový list v tvare oblúka 32

MAM006

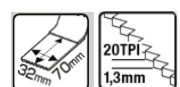

Použitie: Vhodné pre presné ponorné, hlboké a rýchle rezy  
Vhodné aj pre: epoxid, sklolaminát, drevené materiály, pórobeton

rozmer (mm)	typ	ks/bal.	obj. č.	MOC s DPH
32 x 70	TC/HM, Multi I	1	B-66450	25,99 €

### Ponorný pílový list

MAM007

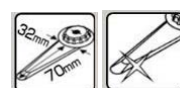

Použitie: na rezanie mäkkých spojov, tmelov na okná, izolačné materiály, kobercov, gumy, lepenky

rozmer (mm)	typ	ks/bal.	obj. č.	MOC s DPH
32 x 70	HCS, Multi M	1	B-66466	13,99 €

### Ponorný pílový list

MAM008



Použitie: na rezanie mäkkých spojov, tmelov na okná, izolačné materiály, kobercov, gumy, lepenky

rozmer (mm)	typ	ks/bal.	obj. č.	MOC s DPH
32 x 55	HCS, Multi M	1	B-66472	6,69 €

## Vhodné najmä pre škárovacie hmoty



### TC pilový kotúč 68

MAM009



Použitie: Vhodné pre frézovanie škár na obkladačkách  
Vhodné aj pre: epoxid, sádkokartón, sklolaminát

priemer (mm)	typ	ks/bal.	obj. č.	MOC s DPH
68	TC/HM grit #50	1	B-66494	28,99 €

### TC pilový kotúč 68

MAM010

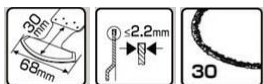

Použitie: Vhodné pre frézovanie škár na obkladačkách  
Vhodné aj pre: epoxid, sádkokartón, sklolaminát

priemer (mm)	typ	ks/bal.	obj. č.	MOC s DPH
68	TC/HM grit #30	1	B-66503	28,99 €

### Diamantový pilový kotúč 68

MAM011

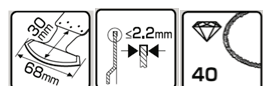

Použitie: Vhodný pre výrezy v mäkkých obkladačkách  
Vhodné aj pre: epoxid, sádkokartón, sklolaminát

priemer (mm)	typ	ks/bal.	obj. č.	MOC s DPH
68	Diamond grit #40	1	B-66519	39,99 €

### Diamantový pilový kotúč 68

MAM012

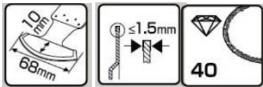

Použitie: Vhodný pre výrezy v mäkkých obkladačkách  
Vhodné aj pre: epoxid, sádkokartón, sklolaminát

priemer (mm)	typ	ks/bal.	obj. č.	MOC s DPH
68	Diamond grit #40	1	B-66525	39,99 €

### TC segmentový pilový kotúč 68

MAM013

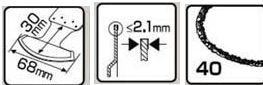

Použitie: Vhodné pre frézovanie škár na obkladačkách  
Vhodné aj pre: epoxid, sádkokartón, sklolaminát

priemer (mm)	typ	ks/bal.	obj. č.	MOC s DPH
68	TC/HM grit #40	1	B-66531	23,99 €

### TC segmentový pilový kotúč 100

MAM014

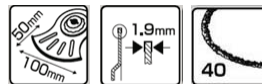

Použitie: Vhodné pre frézovanie škár na obkladačkách  
Vhodné aj pre: epoxid, sklolaminát, drevené materiály

priemer (mm)	typ	ks/bal.	obj. č.	MOC s DPH
100	TC/HM grit #40	1	B-66547	27,99 €

### TC brúsna doska 116

MAM015

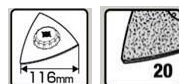

Použitie: Vhodné pre frézovanie škár na obkladačkách  
Vhodné aj pre: epoxid, sklolaminát, drevené materiály

priemer (mm)	typ	ks/bal.	obj. č.	MOC s DPH
116	TC/HM grit #20	1	B-66553	20,99 €

### TC brúsna doska 116

MAM016

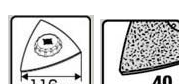

Použitie: Vhodné pre frézovanie škár na obkladačkách  
Vhodné aj pre: epoxid, sklolaminát, drevené materiály

priemer (mm)	typ	ks/bal.	obj. č.	MOC s DPH
116	TC/HM grit #40	1	B-66569	20,99 €

### TC brúsna doska 116

MAM017

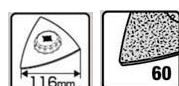

Použitie: Vhodné na brúsenie dreva  
Vhodné aj pre: drevené materiály

priemer (mm)	typ	ks/bal.	obj. č.	MOC s DPH
116	TC/HM grit #60	1	B-66575	20,99 €

### TC brúsna doska 116

MAM018

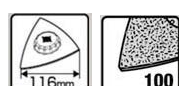

Použitie: Vhodné na brúsenie dreva  
Vhodné aj pre: drevené materiály

priemer (mm)	typ	ks/bal.	obj. č.	MOC s DPH
116	TC/HM grit #100	1	B-66581	20,99 €



# PRÍSLUŠENSTVO

▣ Brúsne kefy



## Brúsne kefy



### Typ kefy



Oceľový drôt s priemerom 0,3 mm  
Ideálny na odstraňovanie hrdze a náterov.



Nylonová (#80)  
Ideálna na odstraňovanie farieb z kovu, dreva a PVC.



Nylonová (#240)  
Ideálna na povrchovú úpravu kovov, dreva a PVC.

### Typ kefy



Miskovitá  
Pre rovné plochy.



Kotúčová  
Pre úzke miesta.



Štetcovitá  
Pre úzke miesta.





Lopatková  
Pre ošetrovanie povrchu dreva.

### AA : odporúčané

Typ kefy			
	Oceľový drôt s priemerom 0,3 mm	Nylonová (#80)	Nylonová (#240)
Drevo 		AA	AA
PVC 		AA	AA
Metal 	AA	AA	AA
Opracovanie (kovový povrch)			 dobrúsené po nylonovej kefe (#80)

## DELENIE: KEFY Z OCEĽOVÉHO DRÔTU

	Ø kefy (mm)	počet vretien	max. otáčky (min <sup>-1</sup> )	upínanie	vhodné pre uhľ. brúsky (Ø mm)	Obj. č.	MOC s DPH
<b>Oceľová drôtená kefa miskovitá - spletaný drôt, Ø drôtu 0,5 mm</b> <span style="float: right;">*****</span>							
	65	18	12500	M14	115 / 125 / 150	P-04488	13,99 €
	100	26	8500	M14	180 / 230	P-04472	25,99 €
<b>Oceľová drôtená kefa kotúčová - spletaný drôt, Ø drôtu 0,5 mm</b> <span style="float: right;">*****</span>							
	100	18	12500	M14	180 / 230	P-04494	17,99 €
<b>Mosadzná drôtená kefa miskovitá - vlnitý drôt, Ø drôtu 0,3 mm</b> <span style="float: right;">***</span>							
	60			M14	125 / 150	D-39746	3,29 €
	75			M14	125 / 150	D-39768	3,79 €
	90			M14	180 / 230	D-39780	5,09 €
	100			M14	180 / 230	D-39805	6,69 €
<b>Oceľová drôtená kefa kotúčová - vlnitý drôt, Ø drôtu 0,3 mm</b> <span style="float: right;">***</span>							
	100			M14	180 / 230	D-39827	4,59 €
	115			M14	180 / 230	D-39849	5,09 €
<b>Oceľová drôtená kefa miskovitá - spletaný drôt, Ø drôtu 0,5 mm</b> <span style="float: right;">***</span>							
	100			M14	180 / 230	D-39861	4,79 €
	115			M14	180 / 230	D-39883	5,99 €
<b>Oceľová drôtená kefa miskovitá - vlnitý drôt, Ø drôtu 0,3 mm</b> <span style="float: right;">***</span>							
	60			M14	125 / 150	D-24072	3,89 €
	75			M14	125 / 150	D-24094	4,69 €
	100			M14	180 / 230	D-29284	6,89 €
<b>Oceľová drôtená kefa miskovitá - spletaný drôt, Ø drôtu 0,5 mm</b> <span style="float: right;">***</span>							
	60			M14	125 / 150	D-24119	6,09 €
	75			M14	125 / 150	D-24131	6,69 €
<b>Oceľová drôtená kefa miskovitá - spletaný drôt, Ø drôtu 0,5 mm</b> <span style="float: right;">***</span>							
	60			M14	125 / 150	D-24153	7,09 €
	100			M14	180 / 230	D-29290	11,99 €

Oblasti využitia kief z oceľového drôtu: odstraňovanie lakov, okovín, hrdze, trosky, odstraňovanie zvyškov betónu a tmelov/stierky zahľadzovanie a začisťovanie zvarov, príprava kovových povrchov pred lakovaním. Mimoriadne prednosti: vysoká tuhosť drôtených vretien, vďaka tomu majú kefy vysoký úberový výkon, húževnatosť, veľmi vysoká pevnosť v ťahu umožňuje vysoké otáčky. Kužeľovitý tvar kefy uľahčuje kefovanie na ťažko prístupných miestach (vnútorné hrany, ryhy, drážky).

## DELENIE: KEFY Z OCEĽOVÉHO DRÔTU

Ø kefy (mm)	počet vretien	max. otáčky (min <sup>-1</sup> )	upínanie	vhodné pre uhl. brúsky (Ø mm)	Obj. č.	MOC s DPH
-------------	---------------	----------------------------------	----------	-------------------------------	---------	-----------

### Oceľová drôtená kefa kotúčová – spletaný drôt, Ø drôtu 0,5 mm



100			M14	125 – 230	D-29555	6,19 €
115			M14	125 – 230	D-29561	7,19 €
125			M14	125 – 230	D-29577	8,69 €
150			M14	180	D-45761	10,49 €
175			M14	230	D-45777	12,99 €

### Oceľová drôtená kefa štetcovitá – vlnitý drôt mosadzný, Ø drôtu 0,3 mm



12		4.500	1/4"		D-73704	1,59 €
19		4.500	1/4"		D-73710	1,89 €
24		4.500	1/4"		D-73726	1,89 €
28		4.500	1/4"		D-73732	2,49 €

### Oceľová drôtená kefa miskovitá – vlnitý drôt mosadzný, Ø drôtu 0,3 mm



38		4.500	1/4"		D-73601	1,69 €
50		4.500	1/4"		D-73617	2,09 €
63		4.500	1/4"		D-73623	2,19 €
70		4.500	1/4"		D-73639	2,09 €
80		4.500	1/4"		D-73645	2,59 €

### Oceľová drôtená kefa kotúčová – vlnitý drôt mosadzný, Ø drôtu 0,3 mm





38		4.500	1/4"		D-73651	1,69 €
50		4.500	1/4"		D-73667	1,69 €
63		4.500	1/4"		D-73673	2,09 €
75		4.500	1/4"		D-73689	2,19 €
100		4.500	1/4"		D-73695	2,59 €

Oblasti využitia kief z oceľového drôtu: odstraňovanie lakov, okovín, hrdze, trosky, odstraňovanie zvyškov betónu a tmelov/stierky zahladzovanie a začisťovanie zvarov, príprava kovových povrchov pred lakovaním.

Mimoriadne prednosti: vysoká tuhosť drôtených vretien, vďaka tomu majú kefy vysoký úberový výkon húževnaté, veľmi vysoká pevnosť v ťahu umožňujú vysoké otáčky kuželovitý tvar kefy uľahčuje kefovanie na ťažko prístupných miestach (vnútorné hrany, ryhy, drážky)

## DELENIE: KEFY Z OCEĽOVÉHO / NEREZOVÉHO DRÔTU S UPÍNANÍM 1/4 "

Ø kefy (mm)	počet vretien	max. otáčky (min <sup>-1</sup> )	upínanie	vhodné pre uhl. brúsky (Ø mm)	Obj. č.	MOC s DPH
<b>Oceľová drôtená kefa miskovitá - vlnitý drôt, Ø drôtu 0,3 mm</b>						
<b>***</b>						
	38	4.500	1/4 "		D-76417	1,99 €
	50	4.500	1/4 "		D-76423	2,19 €
	65	4.500	1/4 "		D-76439	2,39 €
	75	4.500	1/4 "		D-76445	2,79 €
	80	4.500	1/4 "		D-76451	3,29 €

Ø kefy (mm)	počet vretien	max. otáčky (min <sup>-1</sup> )	upínanie	vhodné pre uhl. brúsky (Ø mm)	Obj. č.	MOC s DPH
<b>Oceľová drôtená kefa kotúčová - vlnitý drôt, Ø drôtu 0,3 mm</b>						
	38	4.500	1/4 "		D-76467	1,89 €
	50	4.500	1/4 "		D-76473	1,99 €
	65	4.500	1/4 "		D-76489	2,19 €
	75	4.500	1/4 "		D-76495	2,39 €
	100	4.500	1/4 "		D-76504	2,79 €

Ø kefy (mm)	počet vretien	max. otáčky (min <sup>-1</sup> )	upínanie	vhodné pre uhl. brúsky (Ø mm)	Obj. č.	MOC s DPH
<b>Oceľová drôtená kefa štetcovitá - vlnitý drôt, Ø drôtu 0,3 mm</b>						
	12	4.500	1/4 "		D-76510	1,79 €
	19	4.500	1/4 "		D-76526	2,09 €
	24	4.500	1/4 "		D-76532	2,39 €
	28	4.500	1/4 "		D-76548	2,69 €

Ø kefy (mm)	počet vretien	max. otáčky (min <sup>-1</sup> )	upínanie	vhodné pre uhl. brúsky (Ø mm)	Obj. č.	MOC s DPH
<b>Nerezová drôtená kefa miskovitá - vlnitý drôt, Ø drôtu 0,3 mm</b>						
	38	4.500	1/4 "		D-76554	2,69 €
	50	4.500	1/4 "		D-76560	3,09 €
	65	4.500	1/4 "		D-76576	3,39 €
	75	4.500	1/4 "		D-76582	3,89 €
	80	4.500	1/4 "		D-76598	4,49 €

Ø kefy (mm)	počet vretien	max. otáčky (min <sup>-1</sup> )	upínanie	vhodné pre uhl. brúsky (Ø mm)	Obj. č.	MOC s DPH
<b>Nerezová drôtená kefa kotúčová - vlnitý drôt, Ø drôtu 0,3 mm</b>						
	38	4.500	1/4 "		D-76607	2,59 €
	50	4.500	1/4 "		D-76613	2,69 €
	65	4.500	1/4 "		D-76629	3,09 €
	75	4.500	1/4 "		D-76635	3,39 €
	100	4.500	1/4 "		D-76641	3,89 €

Ø kefy (mm)	počet vretien	max. otáčky (min <sup>-1</sup> )	upínanie	vhodné pre uhl. brúsky (Ø mm)	Obj. č.	MOC s DPH
<b>Nerezová drôtená kefa štetcovitá - vlnitý drôt, Ø drôtu 0,3 mm</b>						
	12	4.500	1/4 "		D-76657	2,59 €
	19	4.500	1/4 "		D-76663	2,89 €
	24	4.500	1/4 "		D-76679	3,39 €
	28	4.500	1/4 "		D-76685	3,69 €

## DELENIE: KEFY Z OCEĽOVÉHO DRÔTU

Ø kefy (mm)	počet vretien	max. otáčky (min <sup>-1</sup> )	upínanie	vhodné pre uhl. brúsky (Ø mm)	Obj. č.	MOC s DPH
<b>Oceľová drôtená kefa miskovitá - spletaný drôt, Ø drôtu 0,5 mm</b>						***
	63		4.500	Ø6	D-73798	4,99 €
	75		4.500	Ø6	D-73807	5,59 €



<b>Oceľová drôtená kefa kotúčová - spletaný drôt, Ø drôtu 0,5 mm</b>						
	75		4.500	Ø6	D-73813	4,99 €
	100		4.500	Ø6	D-73829	4,99 €

<b>Oceľová drôtená kefa štetcovitá - spletaný drôt, Ø drôtu 0,5 mm</b>						
	12		4.500	Ø6	D-73835	2,49 €
	19		4.500	Ø6	D-73841	3,09 €
	24		4.500	Ø6	D-73857	3,69 €
	28		4.500	Ø6	D-73863	4,89 €

## DELENIE: KEFY NYLÓNOVÉ PRE VŔTAČKY

<b>Miskovitá</b>						
	75	jemný (#240)	6	D-45559	6,79 €	
	63	jemný (#240)	6	D-45543	5,49 €	
	50	jemný (#240)	6	D-45537	3,99 €	
	75	hrubý (#80)	6	D-45521	6,29 €	
	63	hrubý (#80)	6	D-45515	5,49 €	
	50	hrubý (#80)	6	D-45509	4,19 €	

<b>Kotúčová</b>						
	38	jemný (#240)	6	D-45618	2,89 €	
	50	jemný (#240)	6	D-45624	8,69 €	
	100	jemný (#240)	6	D-45652	6,79 €	
	50	hrubý (#80)	6	D-45571	3,89 €	
	75	hrubý (#80)	6	D-45593	5,69 €	
	100	hrubý (#80)	6	D-45602	6,89 €	

<b>Štetcovitá</b>						
	12	jemný (#240)	6	D-45705	2,49 €	
	19	hrubý (#80)	6	D-45674	3,09 €	
	30	hrubý (#80)	6	D-45696	4,99 €	

<b>Lopatková</b>						
	100	jemný	6	D-45755	8,19 €	
	100	hrubý	6	D-45749	7,69 €	

# DELENIE: PRÍSLUŠENSTVO PRE UHLOVÉ BRÚSKY

upínanie	popis	vhodné pre uhl. brúsky (ø mm)	Obj. č.	MOC s DPH	
<b>Príruby, matice</b> <span style="float: right;">*****</span>					
	M14	superpríruba	115 – 230	192227-7	14,99 €
	M14	supermatica	115 – 230	196297-8	25,99 €
	M14	špeciálna príruba EZYNUJ	180 – 230	195354-9	78,99 €
	M14	upínacia príruba	115 – 230	224415-9	2,09 €
	M14	príruba	115 – 230	224447-6	1,89 €
	M14	prírubová matica	115 – 150	224554-5	1,56 €
	M14	prírubová matica	180 – 230	224543-0	1,87 €
<b>Rukoväte</b> <span style="float: right;">*****</span>					
	M8	štandard		153489-2	0,65 €
	M14	štandard		152539-0	3,29 €
	M8	antivibračná		162258-0	14,99 €
	M8	štandard	DDA450, DGA504, DGA506, DGA511, DGA513, DGA514, DGA517, DGA518, DGA519, DGA520, DGA521	158237-4	2,39 €
	M14	antivibračná		162264-5	13,99 €
	M14	sada na uchytenie rukoväti	GA7020/S, GA7030/S, GA7040S, GA9020/S, GA9030/S, GA9040S	194684-5	16,99 €
<b>Kľúče</b> <span style="float: right;">*****</span>					
		kľúč kolikový	PC5000C, PC5001C, PC5010C	782426-5	2,09 €
		kľúč kolikový	115 – 150	782423-1	1,79 €
		kľúč kolikový	180 – 230	197610-3	2,49 €
		kľúč kolikový	PC1100	782401-1	1,29 €
<b>Vak na prach</b> <span style="float: right;">*****</span>					
		PC5000C, PC5001C		122853-8	5,69 €
<b>Odsávacie adaptéry pre uhlové brúsky</b> <span style="float: right;">*****</span>					
	brúsenie	C	115 – 125 mm	122B42-7	72,99 €
	brúsenie	C	180 mm	195385-8	83,99 €
	brúsenie	C	115 – 125 mm X-LOCK	191F81-2	50,99 €
	rezanie	A	115 – 125 mm	193794-5	161,99 €
	rezanie	D	115 – 125 mm	196845-3	101,99 €
	rezanie	E	230 mm	198440-5	193,99 €
	rezanie	D	115 – 125 mm	191G06-2	151,99 €
<b>Prídavný kryt pre uhlové brúsky</b> <span style="float: right;">*****</span>					
		vhodný pre kryt ø 115 mm, 123144-0		199709-0	9,59 €
		vhodný pre kryt ø 125 mm, 123145-8		199710-5	12,99 €
<b>Kefky pre brúsne kryty</b>					
		1	195385-8	743334-5	15,99 €
		2	195385-8	743335-3	7,39 €
		1	127147-6	743332-9	18,76 €
		1	PC5000 / 5001 kefka s oceľ. výstuhou	743340-0	20,98 €
		2	PC5000 / 5001 kefka s oceľ. výstuhou	743341-8	11,56 €
		2	127147-6	743333-7	19,47 €
		1	PC5000 / 5001	443144-7	5,20 €
		2	PC5000 / 5001	443145-5	2,80 €
		1	DSL800	140J85-5	49,36 €
		2	DSL800	140J86-3	13,21 €
			DSL801	743127-0	46,99 €

# DELENIE: PRÍSLUŠENSTVO PRE UHLOVÉ BRÚSKY

	model	Obj. č.	MOC s DPH	Obj. č.	MOC s DPH	Obj. č.	MOC s DPH
						*****	
	9557HN/HNR	123098-1	8,22 €	123144-0	13,33 €	122642-1	4,87 €
	9558HN/HNR						
	9562CR	123099-9	8,67 €	135108-2	8,36 €	122911-0	11,02 €
	9562CVR						
	9564H	123098-1	8,22 €	123144-0	13,33 €	122910-2	7,81 €
	9565CR						
	9565CVR	123099-9	8,67 €	135108-2	8,36 €	122911-0	11,02 €
	9565H						
	9565PCV						
	9566CR	135241-0	9,60 €	123146-6	14,67 €	165744-0	11,31 €
	BGA/DGA450	123098-1	8,22 €	123144-0	13,33 €	122910-2	8,34 €
	BGA/DGA452						
	DGA504	123099-9	8,67 €	123145-8	12,44 €	122911-0	11,02 €
	DGA506						
	DGA519					162708-5	9,99 €
	GA5080R						
	GA4530						
	GA4530R						
	GA4540						
	GA4540C01	123098-1	8,22 €	123144-0	13,33 €	122910-2	8,34 €
	GA4540R						
	GA4541C01						
	GA4541R						
	GA4541X01						
	GA5021	123099-9	8,67 €	135108-2	8,36 €	122911-0	11,02 €
	GA5021C						
	GA5030	123099-9	8,67 €	123145-8	12,44 €	122911-0	11,02 €
	GA5030R						
	GA5040						
	GA5040C01	123099-9	8,67 €	123145-8	12,44 €	122911-0	11,02 €
	GA5040R						
	GA5041C01						
	GA5041R						
	GA5041X01						
	GA6021	135241-0	9,60 €	123146-6	14,67 €	165744-0	11,31 €
	GA6021C						
	GA6040C01						
	GA7010C						
	GA7020						
	GA7020F						
	GA7020RF	122889-7	13,82 €	122846-5	18,62 €	122914-4	25,56 €
	GA7030RF01						
	GA7040RF01						
	GA7060R						
	GA7061R						
	GA9010C						
	GA9020						
	GA9020F						
	GA9020RF						
	GA9020RFK						
	GA9030						
	GA9030R						
	GA9030RF01						
	GA9030X01	122891-0	14,53 €	122847-3	20,53 €	122913-6	24,76 €
	GA9040R						
	GA9040RF01						
	GA9050						
	GA9050R						
	GA9060R						
	GA9061R						
	GA9062R						
	GA9063R						
	GA005G						
	GA013G						
	GA023G						
	GA026G			347480-2	8,54 €		
	GA029G						
	GA032G						
	GA5050R						
	GA5051R						

1 – otvorený kryt  
s výmenou na kľúč

2 – otvorený kryt  
s beznástrojovou  
výmenou

3 – zatvorený kryt  
s beznástrojovou  
výmenou



# PRÍSLUŠENSTVO

## ▣ Delenie



Priemer



Počet zubov



Zárez



Hrúbka



Sklon



Ring



Pozdĺžny rez



Priečny rez



Vložený hrot



Silent



M-Force



Rýchly rez



Čistý rez



Extra čistý rez



Coated



Heavy duty



Dlhá životnosť





















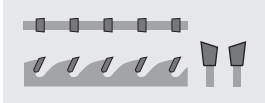
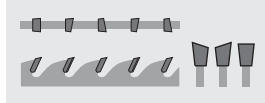
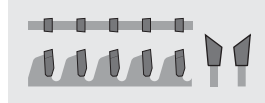
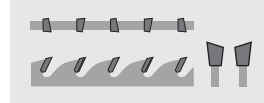
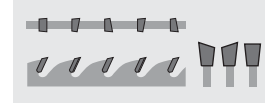



PCD tip





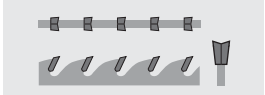
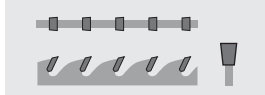
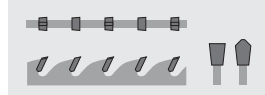

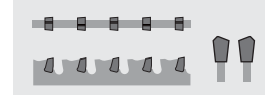
Sharp

**Tvary zubov**

<p><b>ATB</b></p>  	<p><b>ATBR</b></p>  	<p><b>Hi-ATB</b></p>  	<p><b>ATAF</b></p>  	<p><b>ATAFR</b></p>  
<p>Striedané vrchné skosenie zubov vhodný pre drevo a hliník.</p>	<p>Pridané ploché zuby do ATB pre ľahké priame rezanie</p>	<p>Striedané vrchné skosenie zubov s väčším horným uhlom skosenia.</p>	<p>Rezanie dreva , preglejky, dyhy, sololitu, drevovláknitých dosiek a drevotriekových dosiek.</p>	<p>Pridanie plochých zubov do ATAF vhodné pre rovný rez.</p>
				
<p><b>M-FORCE</b></p>  	<p><b>FTG</b></p>  	<p><b>TCG</b></p>  	<p><b>MTCG</b></p>  	<p><b>SMTCG</b></p>  
<p>Predné a vrchné časti zubov tvarujú symetrickú V drážku so znakmi ATB a FTG.</p>	<p>Ploché zuby, umožňujú ľahké priame rezanie a špičky sú zriedka odštiepené. Na rezanie dreva pozdĺž vlákna a rezanie tenkého kovu.</p>	<p>Trapézové a ploché zuby sa striedajú, Umožňuje ľahké priame rezanie a špičky sú zriedka odštiepené.</p>	<p>Ploché zuby so striedavým skosením. Menej rezného odporu ako ploché zuby.</p>	<p>Kontrast k MTCG, asymetrické dve skosenia na hornej časti zuba, ktoré vytvárajú ostré hrany. Umožňuje ľahké zahryznutie do materiálov.</p>
				

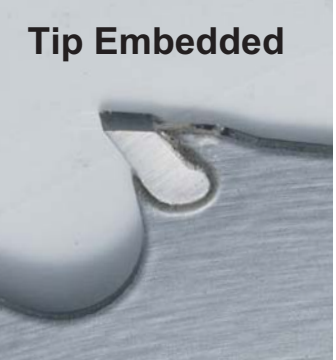
**Technical term**

<p><b>Laser Slit</b></p> 	<p><b>Coated</b></p> 	<p><b>Tip Embedded</b></p> 	<p><b>P.C.D Tip</b></p> 
<p>Systém tlmenia vibrácií Laserom vyrezané telo vyplnené živickou sloty pre hladšie a tichšie strihy.</p>	<p>PTFE (polytetrafluóretylén) potiahnutý kotúč pre zníženie odporu.</p>	<p>Vložený zub zvyšuje tvrdosť tela zubu od špičky.</p>	<p>PCD (polykrystalický diamant) hrot má extrémnu tvrdosť a odolnosť proti opotrebovaniu. Kotúč s hrotom PCD je najlepšou voľbou pre dlhodobé rezanie vláknocementovej dosky.</p>

# Pílové kotúče



Sortiment príslušenstva Makita je vyladenou zmesou zloženou z preverených výrobkov a nápaditých inovácií, dôkladne vybraných tak, aby vyhovovali náročným potrebám profesionálnych užívateľov.

I keď je príslušenstvo Makita konštruované obzvlášť pre použitie s kvalitným náradím firmy Makita, väčšina z nich rovnako účinne rozširuje možnosti pri práci s náradím iných značiek.

## Sortiment TCT pílových kotúčov

Komplexný sortiment TCT pílových kotúčov, ktorých konštrukcia vyhovuje pílam od firmy Makita i mnoho iných výrobcov. Vysoko kvalitnými pílovými kotúčmi firmy Makita, vyrobenými z tej najlepšej oceli podľa najprísnejších noriem, sa spoľahlivo prevádzajú veľmi presné rezy. Každý zub má perfektne nabrúsené ostrie, ktoré znižuje množstvo malých triesok, čím zaisťuje ostrejšiu a presnejšiu hranu rezu.

Sortiment zahŕňa 5 rôznych typov pílových kotúčov pre ručné a stacionárne náradie.

Makita vyrába vysoko kvalitné príslušenstvo, ktoré v kombinácii s akýmkoľvek profesionálnym náradím vytvorí účinné a spoľahlivé riešenie pre každú prácu.

Mforce sú kotúče s revolučne vyvinutou konštrukciou zubu a dvojitémi zubmi pre rýchlejší a čistejší rez.

Makforce je komplexná rada kvalitne vyrobených ručných pílových kotúčov určených pre široké spektrum aplikácií. Majú vysokokvalitné špičky z karbidu wolframu a predĺženú životnosť.

Makblade Plus sú prvotriedne kotúče pre pokosové a stolné píly so špeciálnou konštrukciou zaručujúcou minimálne vibrácie a tichý chod.

Makblade predstavuje radu kotúčov pre pokosové a akumulátorové píly zahŕňajúce všetky obľúbené značky a modely. Kombinujú v sebe čistý presný rez a dlhú životnosť.

Špeciálne kotúče pre zvláštne aplikácie, stroje alebo materiály. Špeciálne konštruované zuby pre rezanie klinec a „hřč“, hliníku a oceli alebo pre akumulátorové píly.

## Ako čítať kódy výrobkov makita

		Typ rezu C = Hrubý M = Stredný F = Čistý XF = Extra čistý	Priemer listu Ø mm	Víťanie Ø mm A = 10 mm B = 15 mm C = 15,88 mm D = 16 mm E = 20 mm F = 25,4 mm G = 30 mm
CSCX23024GL				
<b>Typ pílového kotúča</b> MS = Pokosová píla CS = Okružná píla TS = Stolná píla CMS = Akku pokosová píla CC = Akku okružná píla BSS = BSS610 Li-ion CSP = ponorná okružná píla MCS = Píla na kov		<b>Špeciálny kotúč</b> X = Mforce E = zub so zapustenou špičkou A = hliník	<b>Počet zubov</b>	<b>Zvláštne vlastnosti</b> L = Laserová štrbina a tichý

### PRÍKLADY:

MSXF305100GL: pokosová píla – veľmi jemný rez – Ø 305 mm – 100 zubov – víťanie 30 mm – laserová štrbina a tichý chod

CCM15024A: akku kotúčová píla – stredný rez – Ø 150mm – 24 zubov – víťanie 10 mm

TSA20064G: stolná píla – na hliník – Ø 200 mm – 64 zubov – víťanie 30 mm

## DELENIE:



### Funkcia

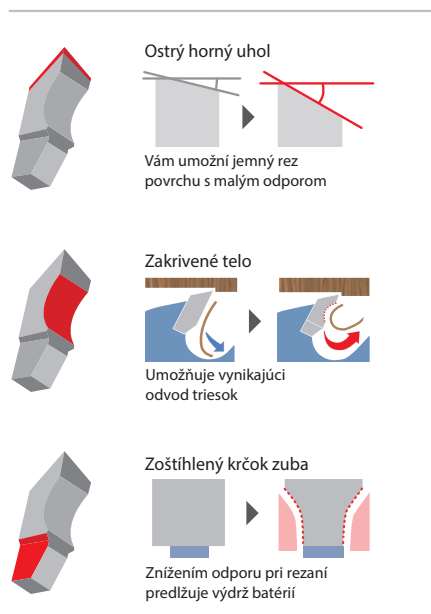

**Viac rezov na jedno nabitie**



**Rýchly rez**



**Dlhšia životnosť**

Počet rezov na 1 nabitie

Hrúbka kotúča: 1,6 mm



165mm x 48T

Hrúbka kotúča: 1,0 mm



165mm x 50T

**EFFICUT**

100

**× 2,4 viac**

240

Výsledky skúšky závisia vo veľkej miere od tvrdosti drevených materiálov atď.

Ø kotúča (mm)	ID kód	hrúbka rezu (mm)	vrtanie (mm)	počet zubov	hrúbka kotúča (mm)	uhol zuby	tvar zuby	max. otáčky (min <sup>-1</sup> )	materiál	Obj. č.	MOC s DPH
165	CCM16525E	1,4	20	25	1	23°	ATAFR	9250	drevo	B-62985	33,99 €
165	CCXF16556EL	1,45	20	56	1	23°	ATAFR	9250	drevo, mdf, laminát	B-57336	64,99 €
165	CMSF16560E	1,85	20	60	1,35	10°	ATAFR	9250	drevo	B-69858	53,99 €
185	CCM18524G	1,45	30	24	1	23°	ATAFR	8250	drevo	E-08676	29,99 €
190	CCM19024G	1,45	30	24	1	23°	ATAFR	8040	drevo	B-64185	30,99 €
190	CCF19045G	1,45	30	45	1	23°	ATAFR	8250	drevo	B-68638	44,99 €
190	CMSC19025E	1,85	20	20	1,35	10°	ATBR	8040	drevo	E-11140	39,99 €
190	CMSM19045E	1,85	20	45	1,35	10°	ATBR	8040	drevo	E-11156	59,99 €
190	CMSF19060E	1,85	20	60	1,35	10°	ATBR	8040	drevo	E-11162	64,99 €
216	CMSM21645G	2	30	45	1,5	10°	ATAFR	7070	drevo	E-06971	54,99 €
216	CMSF21660G	2	30	60	1,5	10°	ATABR	7070	drevo	E-08888	59,99 €
216	CMSXF21680G	2	30	80	1,5	10°	ATABR	7070	drevo	E-08894	78,99 €
235	CCM23524G	2,2	30	24	1,5	20°	ATBR	6500	drevo	E-01915	51,99 €
260	CMSM26045G	2,15	30	45	1,65	10°	ATBR	5870	drevo	B-64624	59,99 €
260	CMSF26060G	2,15	30	60	1,65	10°	ATBR	5870	drevo	B-67284	70,99 €
260	CMSXF26080G	2,15	30	80	1,65	10°	ATBR	5870	drevo	B-67240	80,99 €
305	CMSM30560G	2,15	30	60	1,65	10°	ATBR	5000	drevo	B-67309	86,99 €
305	CMSF30580G	2,15	30	80	1,65	10°	ATBR	5000	drevo	B-67262	87,99 €
305	CMSXF305100G	2,15	30	100	1,65	10°	ATBR	5000	drevo	B-67278	104,99 €



## Funkcia

**Tvrde, odolné voči ulomeniu**  
 ×   
 Špeciálny dizajn špičky čepele zvyšuje účinnosť a životnosť.

**Ľahký odvod pilín**  
 ×   
 Vynikajúci pri priamom rezaní

Zataženie špičiek kotúčov je možné efektívne rozložiť, aby sa potlačilo kolísanie pílového kotúča, čo zaisťuje rovnomerné priame rezanie a zvyšuje odolnosť proti zlomeniu hrotu.

**Viac rezov na jedno nabitie**

Hrúbka kotúča: 1,2 mm  
 150mm x 32T

Hrúbka kotúča: 0,95 mm  
 150mm x 33T  
**EFFICUT Metal**

Počet rezov na 1 nabitie

100	× 1,6 viac
160	

Model: DCS553 (BL1860B)  
 Materiál: rúrka z uhlíkovej ocele (priemer: 31 mm / hrúbka: 3 mm)

## Rýchly rez



## Dlhšia životnosť

Ø kotúča (mm)	ID kód	hrúbka rezu (mm)	vrtanie (mm)	počet zubov	hrúbka kotúča (mm)	uhol zubu	tvar zubu	max. otáčky (min <sup>-1</sup> )	materiál	Obj. č.	MOC s DPH
---------------	--------	------------------	--------------	-------------	--------------------	-----------	-----------	----------------------------------	----------	---------	-----------

### EFFICUT na kov \*\*\*\*\*

136	MCCS13630E	1,1	20	30	0,95	0°	SMTCG	4.500	železo	B-69266	50,99 €
136	MCCS13645E	1,1	20	45	0,95	0°	SMTCG	4.500	nerez	B-69272	61,99 €
150	MCCS15033E	1,1	20	33	0,95	0°	SMTCG	4.680	železo	B-69288	54,99 €
150	MCCS15048E	1,1	20	48	0,95	0°	SMTCG	4.680	nerez	B-69331	67,99 €
185	MCCS18560GL	1,4	30	60	1,2	0°	SMTCG	5.800	kov/nerez	E-12843	112,99 €
185	MCCS18545GL	1,4	30	45	1,2	0°	SMTCG	5.800	kov	E-12859	90,99 €
305	MCS3063FL	2	25,4	63	2	0°	SMTCG	2.000	kov	E-12049	203,99 €

### EFFICUT na hliník \*\*\*\*\*

165	CMSA16554EL	1,5	20	54	1,15	-3°	SMTCG	9.250	Hliník	E-16760	73,99 €
216	CMSA21663GL	1,85	30	63	1,5	0°	SMTCG	7.070	Hliník	E-16916	91,99 €
305	CMSA30581GL	2	30	81	1,65	-3°	SMTCG	5.000	Hliník	E-13247	127,99 €
305	CMSA30596GL	2	30	96	1,65	-3°	SMTCG	5.000	Hliník	E-13306	143,99 €

### Špeciálne kotúče na kovy pre aku píly DCS550/551/552/553 \*\*\*\*\*

150	MCCS15052E	1,4	20	52	1,1	-15°	ATB	4680	tenký plech	B-47167	65,99 €
-----	------------	-----	----	----	-----	------	-----	------	-------------	---------	---------

### Špeciálne pílové kotúče na kov a nehrdzavejúcu oceľ \*\*\*\*\*

136	MCS13656E	1,5	20	56	1,5	-5°		3 600	nerez	B-23086	69,99 €
185	MCSF18564GL	1,6	30	64	1,3	0°		5 800	nerez	B-31669	97,99 €
305	MCS305100F	2,4	25,4	100	1,5	-5°		2 000	nerez	B-23123	299,99 €

### Frézovacie kotúče pre CA5000 \*\*\*\*\*

118		14	20	6	6,0	5°	TCG		frézovací kotúč na hliník pre 90° ohyb materiálu.	B-48832	173,99 €
118		18	20	6	6,0	5°	TCG		frézovací kotúč na hliník pre 135° ohyb materiálu.	B-48860	228,99 €

### Pílové kotúče EFFICUT určené pre pílenie WPC dosiek \*\*\*\*\*

165	CCF16540EL	1,5	20	40	1	15°	ATAFR	9.250	WPC dosky	E-12158	43,99 €
190	CMSF19050EL	1,85	20	50	1,35	8°	ATAFR	8.040	WPC dosky	E-12186	62,99 €
216	CMSF21660GL	2	30	60	1,5	8°	ATAFR	7070	WPC dosky	E-12267	69,99 €
260	CMSF26075GL	2,15	30	75	1,65	8°	ATAFR	5.870	WPC dosky	E-12201	82,99 €

Sortiment kotúčov na rezanie nehrdzavejúcej ocele od spoločnosti Makita je navrhnutý na čistejšie a rýchlejšie rezanie.

Špeciálne vyrobený karbid v kombinácii s jedinečným dizajnom hrotu odoláva poškodeniu pri náraze a vydrží dlhšie, kotúče Makita vydržia až 30-krát viac ako štandardné kotúče.

- Špeciálne tvarované špičky z tvrdokovu precízne brúsené pre rýchle čisté rezanie.
- Nízke iskrenie a minimálna tvorba prachu.
- Chladné rezy s okrajmi bez otrepu.

# DELENIE: PÍLOVÉ KOTUČE

Ø kotúča (mm)	ID kód	hrúbka zubu (mm)	vŕtanie (mm)	počet zubov	hrúbka kotúča (mm)	uhol zubu	Ø kružku (mm)	rez priechy	rez pozdĺžny	max. otáčiky (min <sup>-1</sup> )	materiál	Obj. č.	MOC s DPH
<b>*****</b>													
165	CSCX16510G	2	30	10	1,2	15°		•	•	9 250	drevo	B-07892	20,99 €
165	CSCX16516E	2	20	16	1,2	15°		•	•	9 250	drevo	B-31930	22,99 €
165	CSCX16524E	2	20	24	1,2	15°		•	•	9 250	drevo	B-32007	24,99 €
170	CSCX17016G	2	30	16	1,2	15°	15,88	•	•	8 980	drevo	B-07917	20,99 €
170	CSMX17024G	2	30	24	1,2	15°	15,88	•	•	8 980	drevo	B-08012	22,99 €
180	CSCX18016E	2	20	16	1,2	15°		•	•	8 480	drevo	B-07923	21,99 €
180	CSCX18016G	2	30	16	1,2	15°		•	•	8 480	drevo	B-07939	21,99 €
180	CSMX18024E	2	20	24	1,2	15°		•	•	8 480	drevo	B-08028	24,99 €
180	CSMX18024G	2	30	24	1,2	15°		•	•	8 480	drevo	B-08034	22,99 €
185	CSCX18516G	2	30	16	1,2	15°	15,88/20	•	•	8 250	drevo	B-31968	24,99 €
185	CSMX18524G	2	30	24	1,2	15°	15,88/20	•	•	8 250	drevo	B-32035	27,99 €
190	CSCX19012C	2	15,88	12	1,2	15°		•	•	8 040	drevo	B-07951	22,99 €
190	CSCX19012G	2	30	12	1,2	15°	15,88/20	•	•	8 040	drevo	B-31974	25,99 €
190	CSMX19024G	2	30	24	1,2	15°	15,88/20	•	•	8 040	drevo	B-32041	27,99 €
190	CSMX19024C	2	15,88	24	1,2	15°		•	•	8 040	drevo	B-08062	23,99 €
210	CSCX21016G	2,3	30	16	1,4	15°		•	•	7 300	drevo	B-07973	31,99 €
210	CSMX21024G	2,3	30	24	1,4	15°		•	•	7 300	drevo	B-08078	34,99 €
210	CSFX21040G	2,3	30	40	1,4	15°		•	•	7 300	drevo	B-32079	43,99 €
230	CSCX23018G	2,3	30	18	1,6	15°		•	•	6 640	drevo	B-07989	31,99 €
230	CSMX23024G	2,3	30	24	1,6	15°		•	•	6 640	drevo	B-08084	41,99 €
230	CSFX23040G	2,3	30	40	1,6	15°		•	•	6 640	drevo	B-08115	37,99 €
235	CSCX23520G	2,3	30	20	1,6	15°	15,88/25	•	•	6 500	drevo	B-31996	38,99 €
235	CSMX23524G	2,3	30	24	1,6	15°		•	•	6 500	drevo	B-08090	39,99 €
235	CSFX23540G	2,3	30	40	1,6	15°	15,88/25	•	•	6 500	drevo	B-08121	42,99 €

## Pre kotúčové píly

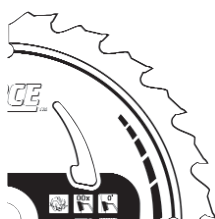

Revolučná zdokonalená konštrukcia zubu, ktorá stanovuje nový medzník v technológii pílových kotúčov. Dvojito zošíkmený bok zubu má ostrejšie rezné hrany a tvar M je rovnocenný dvojnásobnému počtu zubov na kotúči. Väčšia trecia plocha a viac rezných plôch má za následok, že kotúč vydrží až 2x dlhšie ako tradičné kotúče.

Rovnaký výsledok s polovicou zubov  
Agresívny rez  
Väčšia trecia plocha a dlhšia životnosť

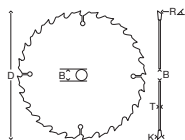

### DLHŠIA ŽIVOTNOSŤ

Zošikmená bočná a horná plocha vytvára 6 rezných hrán, čím výrazne predlžuje životnosť v porovnaní s tradičnými kotúčmi.



### VÄČŠIA RÝCHLOSŤ REZU

Zošikmený bok zubu má dva uhly 10, ktoré vytvárajú agresívnejší a rýchlejší rez.



### ČISTEJŠÍ REZ

Špička tvaru M má viac rezných bodov, čo spôsobuje čistejší rez. Kotúč s 24 zubami má rovnaký výsledok ako 48 zubov u tradičných kotúčov.



# DELENIE: PÍLOVÉ KOTUČE

Ø kotúča (mm)	ID kód	hrúbka zubu (mm)	vrtanie (mm)	počet zubov	hrúbka kotúča (mm)	uhol zubu	Ø kružku (mm)	rez priechy	rez pozdĺžny	max. otáčky (min <sup>-1</sup> )	materiál	Obj. č.	MOC s DPH
<b>*****</b>													
140	CSC14018C	1,5	15,88	18	1	20°		• •	10 910		drevo	B-08137	27,99 €
150	CSM15024E	2,4	20	24	1,5	20°		• •	10 180		drevo	B-08280	32,99 €
160	CSC16016E	2,4	20	16	1,5	20°	15,88	• •	9 540		drevo	B-08143	27,99 €
160	CSM16024E	2,4	20	24	1,5	20°	15,88	• •	9 540		drevo	B-32203	38,99 €
160	CSM16040E	2,4	20	40	1,5	20°	15,88	• •	9 540		drevo	B-32297	42,99 €
165	CSC16510E	2	20	10	1,4	20°		• •	9 250		drevo	B-32100	31,99 €
165	CSC16510G	2	30	10	1,4	20°		• •	9 250		drevo	B-08165	25,99 €
165	CSM16524G	2,4	30	24	1,5	20°		• •	9 250		drevo	B-08305	29,99 €
165	CSM16540G	2,4	30	40	1,5	20°		• •	9 250		drevo	B-32306	43,99 €
170	CSC17016G	2,4	30	16	1,5	20°	15,88	• •	8 980		drevo	B-08171	24,99 €
170	CSM17024G	2,4	30	24	1,5	20°	15,88	• •	8 980		drevo	B-08311	30,99 €
180	CSC18016G	2,4	30	16	1,5	20°		• •	8 480		drevo	B-08193	25,99 €
180	CSM18024E	2,4	20	24	1,5	20°		• •	8 480		drevo	B-08327	31,99 €
180	CSM18024G	2,4	30	24	1,5	20°		• •	8 480		drevo	B-08333	30,99 €
180	CSM18040E	2,4	20	40	1,5	20s		• •	8 480		drevo	B-32328	46,99 €
180	CSM18040G	2,4	30	40	1,5	20°		• •	8 480		drevo	B-32334	46,99 €
185	CSC18516C	1,8	15,88	16	1,2	20°		• •	8 250		drevo	B-08202	26,99 €
185	CSM18524C	1,8	15,88	24	1,2	20°		• •	8 250		drevo	B-08349	31,99 €
185	CSM18540C	1,8	15,88	40	1,2	20°		• •	8 250		drevo	B-08470	39,99 €
190	CSC19012G	2	30	12	1,4	20°	15,88/20	• •	8 040		drevo	B-32144	30,99 €
190	CSM19024G	2,2	30	24	1,4	20°	15,88/20	• •	8 040		drevo	B-32247	35,99 €
190	CSM19024C	2,2	15,88	24	1,4	20°		• •	8 040		drevo	B-08361	32,99 €
190	CSM19040G	2,2	30	40	1,4	20°	15,88/20	• •	8 040		drevo	B-32340	44,99 €
190	CSM19040C	2,2	15,88	40	1,4	20°		• •	8 040		drevo	B-08492	34,99 €
190	CSXF19060G	2,2	30	60	1,4	15°	15,88/20	• •	8 040		drevo	B-32390	44,99 €
210	CSM21024G	2,4	30	24	1,6	20°		• •	7 300		drevo	B-08377	40,99 €
210	CSM21040G	2,4	30	40	1,6	20°		• •	7 300		drevo	B-32356	48,99 €
230	CSM23024G	2,3	30	24	1,6	20°		• •	6 640		drevo	B-08383	42,99 €
230	CSM23040G	2,6	30	40	1,6	20°		• •	6 640		drevo	B-08517	57,99 €
230	CSXF23060G	2,8	30	60	1,8	15°		• •	6 640		drevo	B-08567	45,99 €
235	CSC23518G	2,6	30	18	1,6	20°		• •	6 500		drevo	B-08252	44,99 €
235	CSM23520G	2,3	30	20	1,6	20°		• •	6 500		drevo	B-32269	35,99 €
235	CSM23524G	2,3	30	24	1,6	20°		• •	6 500		drevo	B-08408	43,99 €
235	CSM23540G	2,6	30	40	1,6	20°		• •	6 500		drevo	B-08523	46,99 €
235	CSXF23560G	2,8	30	60	1,8	15°		• •	6 500		drevo	B-32415	50,99 €
270	CSC27024G	2,6	30	24	1,8	20°		• •	5 650		drevo	B-32172	56,99 €
270	CSM27040G	2,6	30	40	1,6	20°		• •	5 650		drevo	B-32378	76,99 €
270	CSXF27060G	2,8	30	60	1,8	15°	20	• •	5 650		drevo	B-32409	76,99 €
355	CSC35524G	3	30	24	2,2	20°		• •	4 300		drevo	B-32188	82,99 €
355	CSM35540G	3	30	40	2,2	20°		• •	4 300		drevo	B-32281	104,99 €
355	CSM35560G	3	30	60	2,2	20°		• •	4 300		drevo	B-08545	93,99 €



Komplexná rada pilových kotúčov pre všetky značky a modely ručných kotúčových píl. Bohatý výber veľkostí od 140 mm – 355 mm a počtu zubov od 10 – 60 pokrýva možnosti použitia pre hrubé pozdĺžne a priečne rezy až po extra jemné priečne rezy. Tvrdené a vystužené kotúče absorbujú rázy a zostávajú ploché a rovné. Výrazné predĺženie životnosti kotúčov vďaka použitiu prvotriedneho karbidu wolframu s pomalým opotrebením. Úzka rezná špára s menším množstvom odpadu a menším vodiacim tlakom.

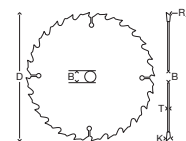

## DELENIE: PÍLOVÉ KOTUČE

Ø kotúča (mm)	ID kód	hrúbka zubu (mm)	vrtanie (mm)	počet zubov	hrúbka kotúča (mm)	uhol zubu	Ø križku (mm)	rez priechy	rez pozdĺžny	max. otáčky (min <sup>-1</sup> )	materiál	Obj. č.	MOC s DPH
190	MSC19024EL	2,2	20	24	1,6	5°		•		8 040	drevo	B-08604	51,99 €
190	MSF19060EL	2	20	60	1,4	5°		•		8 040	drevo	B-08757	67,99 €
216	MSM21648GL	2,4	30	48	1,6	5°		•		7 070	drevo	B-08632	86,99 €
216	MSM21660GL	2,1	30	60	1,6	5°		•		7 070	drevo	B-32502	95,99 €
216	MSXF21680GL	2,8	30	80	1,8	5°		•		7 070	drevo	B-08791	104,99 €
250	TSM25040GL	2,8	30	40	1,8	20°		• •		6 110	drevo	B-09818	108,99 €
250	TSF25080GL	2,8	30	80	1,8	15°		• •		6 110	drevo	B-08838	167,99 €
255	MSC25532GL	2,3	30	32	1,8	5°		•		5 990	drevo	B-08626	77,99 €
255	MSM25540GL	2,4	30	40	1,8	5°		•		5 990	drevo	B-08648	95,99 €
255	MSM25560GL	2,3	30	60	1,8	5°		•		5 990	drevo	B-08682	108,99 €
255	MSF25572GL	2,4	30	72	1,8	5°		•		5 990	drevo	B-08763	107,99 €
260	MSM26040GL	2,3	30	40	1,8	5°		•		5 870	drevo	B-32487	108,99 €
260	TSM26040GL	2,8	30	48	1,8	20°		• •		5 870	drevo	B-09824	140,99 €
260	MSM26060GL	2,3	30	60	1,8	5°		•		5 870	drevo	B-08698	109,99 €
260	MSM26070GL	2,3	30	70	1,8	5°		•		5 870	drevo	B-08707	90,99 €
260	MSF26080GL	2,3	30	80	1,8	5°		•		5 870	drevo	B-08779	113,99 €
260	TSF26080GL	2,8	30	80	1,8	15°		• •		5 870	drevo	B-08844	140,99 €
260	MSXF260100GL	2,3	30	100	1,8	5°		•		5 870	drevo	B-08800	122,99 €
300	TSM30048GL	2,8	30	48	1,8	20°		• •		5 090	drevo	B-09830	120,99 €
305	MSM30540GL	2,3	30	40	1,8	5°		•		5 000	drevo	B-32493	125,99 €
305	MSM30560GLA	2,6	30	60	2	5°		•		5 000	drevo	B-08729	139,99 €
305	MSM30570GL	2,5	30	70	1,9	0°		•		5 000	drevo	B-08735	116,99 €
305	MSF30580GL	2,3	30	80	1,8	5°		•		5 000	drevo	B-32611	164,99 €
305	MSXF305100GL	2,3	30	100	1,8	5°		•		5 000	drevo	B-08816	155,99 €
350	TSM35056GL	3,5	30	56	2,5	20°		• •		4 360	drevo	B-09846	134,99 €
355	MSM35580GL	3	30	80	2,2	5°		•		4 300	drevo	B-08741	193,99 €

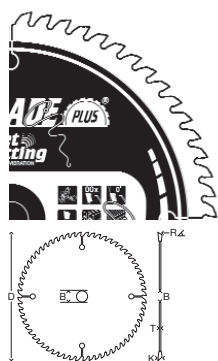

Pílové kotúče Makblade Plus pre pokosové a stolné píly majú jedinečnú patentovanú technológiu. Tieto kotúče sú vyvinuté k pohlienu vibrácií a veľmi tichému chodu. Majú vlastnosti zlepšovať pracovné prostredie, životnosť kotúča a spoľahlivosť celého zariadenia. Kotúč s menšími vibráciami zaisť presnejšie vedenie rezu a tiež znižuje hádzavosť. Výsledným efektom je ideálna rezná plocha. Taktiež má za dôsledok významne dlhšiu životnosť zubov z karbidu wolframu prekračujúcu životnosť konvenčných pílových kotúčov s karbidovými hrotmi.

Presne vystužené kotúče s plochejším ostrím a rovnejším rezom

Povrchová vrstva s veľmi malým trením znamená rezanie bez námahy a ochranu pred koróziou.



### NÍZKE VIBRÁCIE

Vďaka antivibračnej laserom rezanej drážke.



### TICHÉ REZANIE

Povrchová vrstva s veľmi malým trením. Hlučnosť pílového kotúča je jednou z hlavných nepríjemností na pracovisku. MakBlade plus zaisťujú menej hlučné pracovné prostredie.

**Quiet Cutting**  
WITH LESS VIBRATION



# DELENIE: PÍLOVÉ KOTUČE

Ø kotuča (mm)	ID kód	hrúbka zubu (mm)	vrtanie (mm)	počet zubov	hrúbka kotuča (mm)	uhol zubu	Ø kružku (mm)	rez priechny	rez pozdĺžny	max. otáčky (min <sup>-1</sup> )	materiál	Obj. č.	MOC s DPH
<b>Pre pokosové a stolné píly</b> <span style="float: right;">*****</span>													
190	MSC19024E	2,2	20	24	1,6	5°				• 8 040	Drevo	B-08894	31,99 €
190	MSM19048E	2,2	20	48	1,6	5°				• 8 040	Drevo	B-08953	51,99 €
190	MSF19060E	2	20	60	1,4	5°				• 8 040	Drevo	B-09042	50,99 €
216	MSC21624G	2,4	30	24	1,6	5°				• 7 070	Drevo	B-32714	47,99 €
216	CMSM21640G	2,1	30	40	1,6	10°				• 7 070	Drevo	B-08872	64,99 €
216	MSM21648G	2,4	30	48	1,6	5°				• 7 070	Drevo	B-32764	64,99 €
216	MSF21660G	2	30	60	1,4	5°				• 7 070	Drevo	B-32839	59,99 €
216	MSXF21680G	2,8	30	100	1,8	5°				• 7 070	Drevo	B-32867	61,99 €
250	MSC25032G	2,4	30	32	1,6	5°				• 6 110	Drevo	B-08919	48,99 €
250	MSM25048G	2,4	30	48	1,8	5°				• 6 110	Drevo	B-08975	60,99 €
250	MSM25060G	2,3	30	60	1,8	5°				• 6 110	Drevo	B-09008	64,99 €
250	MSF25072G	2,4	30	72	1,8	5°				• 6 110	Drevo	B-09064	63,99 €
250	MSXF250100G	2,3	30	100	1,8	5°				• 6 110	Drevo	B-09101	70,99 €
255	MSC25532G	2,3	30	32	1,8	5°				• 5 990	Drevo	B-08925	82,99 €
255	CMSM25548G	2,1	30	48	1,6	10°				• 5 990	Drevo	B-32699	72,99 €
255	MSM25560G	2,3	30	60	1,8	5°				• 5 990	Drevo	B-32792	62,99 €
260	MSC26032G	2,3	30	32	1,8	5°				• 5 870	Drevo	B-32736	60,99 €
260	MSM26040G	2,3	30	40	1,8	5°				• 5 870	Drevo	B-32770	45,99 €
260	MSM26060G	2,3	30	60	1,8	5°				• 5 870	Drevo	B-32801	61,99 €
260	MSF26080G	2,3	30	80	1,8	5°				• 5 870	Drevo	B-32845	67,99 €
260	MSXF260100G	2,3	30	100	1,8	5°				• 5 870	Drevo	B-09117	79,99 €
305	MSC30532G	2,3	30	32	1,8	5°				• 5 000	Drevo	B-08947	62,99 €
305	MSM30540G	2,3	30	40	1,8	5°				• 5 000	Drevo	B-32786	68,99 €
305	MSM30560G	2,3	30	60	1,8	5°				• 5 000	Drevo	B-32817	87,99 €
305	MSF30580G	2,3	30	80	1,8	5°				• 5 000	Drevo	B-32851	93,99 €
305	MSXF305100G	2,3	30	100	1,8	5°				• 5 000	Drevo	B-32889	101,99 €
315	TSC31528G	2,8	30	28	2,0	20°				• 4850	Drevo	B-46171	78,99 €
315	TSC31560G	2,8	30	60	2,0	10°				• 4850	Drevo	B-46193	98,99 €
315	TCS31540G	2,8	30	40	2,0	9°				• 4 850	Drevo	JM27170005	38,99 €

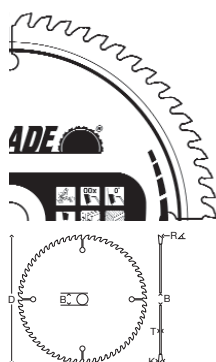

Komplexný výber pílových kotučov pre všetky značky a modely pokosových píl a ponorných píl vrátane akku píl.

Bohatý výber veľkostí od 190 mm–305 mm a počtu zubov od 24 do 100 pokrýva možnosti použitia od hrubých rezov až po prácu so zvlášť jemnou povrchovou úpravou.

Tvrdené a vystužené kotúče absorbujú rázy a zostávajú ploché a rovné.

Úzka rezná špára s menším množstvom odpadu.

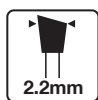

### MENŠIA NÁMAHA

Úzka rezná špára znižuje namáhanie počas práce a predlžuje predpokladanú životnosť ako stroja, tak kotuča.



### DLHÁ ŽIVOTNOSŤ

Prvotriedne zuby TCT, pomalé opotrebenie.

## DELENIE: PÍLOVÉ KOTUČE

Ø kotúča (mm)	ID kód	hrúbka zubu (mm)	vrtanie (mm)	počet zubov	hrúbka kotúča (mm)	uhol zubu	Ø kružku (mm)	rez priechy	rez pozdĺžny	max. otáčky (min <sup>-1</sup> )	materiál	Obj. č.	MOC s DPH
<b>Špeciálne kotúče pre akku píly</b> <span style="float: right;">*****</span>													
85	CCF8520B	1	15	20	0,7	10°		• •	2 240		drevo	B-33576	12,99 €
136	CCM13624A	1,5	10	24	1	20°		• •	4 500		drevo	B-09139	26,99 €
136	CCF13636A	1,5	10	36	1	18°		• •	4 500		drevo	B-09210	27,99 €
136	CCC13616E	1,5	20	16	1	20°		• •			drevo	B-10643	30,99 €
136	MCCS13630E	1,5	20	30	1,2	0°		• •			kov	B-33526	68,99 €
150	CCM15024A	1,5	10	24	1	20°		• •	2 500		drevo	B-09145	26,99 €
150	CCF15040A	1,5	10	40	1	18°		• •	2 500		drevo	B-09226	32,99 €
160	CCC16024E	1,5	20	24	1	20°		• •	4 770		drevo	B-09151	33,99 €
165	CCC16524E	1,5	20	16	1	20°		• •	4 770		drevo	D-51079	11,99 €
165	BBS16524E	1,5	20	24	1	20°		• •	4 770		drevo	B-32910	28,99 €
165	CCC16524E	1,5	10	24	1	20°		• •	4 770		drevo	B-09189	26,99 €
165	CCF16540E	1,6	20	40	1	18°		• •	4 770		drevo	B-32954	32,99 €
165	BBS16540E	1,6	20	40	1	18°		• •	4 770		drevo	B-32960	31,99 €
190	CCC19024G	2	30	24	1,4	20°		• •	3 000		drevo	B-32926	31,99 €
190	CCM19040G	2	30	40	1,4	10°		• •	3 000		drevo	B-32976	39,99 €

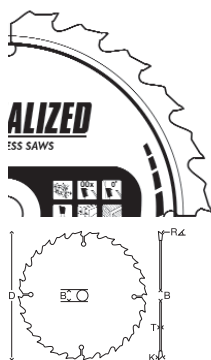

Ušľachtilé pílové kotúče vyrobené špeciálne pre AKKU píly. Ponúkame kotúče na rezanie dreva pomocou všetkých modelov AKKU kotúčových píľ v kvalite firmy Makita. Ultratenké, perfektne vystužené oceľové kotúče pre rovné vedenie. Predlžuje výdrž batérií. Presne brúsené z prvotriedneho karbidu pre ľahšie, hladšie rezy a dlhú životnosť. Usporiadanie zubov odpovedá zvláštnym požiadavkám na rezanie.

## Pílové kotúče na laminátové dosky

Ø kotúča (mm)	ID kód	hrúbka zubu (mm)	vrtanie (mm)	počet zubov	hrúbka kotúča (mm)	uhol zubu	Ø kružku (mm)	rez priechy	rez pozdĺžny	max. otáčky (min <sup>-1</sup> )	materiál	Obj. č.	MOC s DPH
<b>Pílové kotúče na laminátové dosky</b> <span style="float: right;">*****</span>													
85 mm	CCXF8524B	1	15	24	0,7	7°				2240	laminát	B-33819	23,99 €
136 mm	CCXF13648E	1.4	20	48	1	10°				4500	laminát	B-33825	45,99 €
165 mm	CCXF16552EL	1.45	20	52	1	5°				4770	laminát	B-33831	68,99 €
190 mm	MSXF19060GL	2	20	60	1,4	5°				8040	laminát	B-33847	80,99 €
216 mm	MSXF21672GL	2.5	30	72	1,8	5°				7070	laminát	B-29474	105,99 €
250 mm	MSXF25084GL	2.5	30	84	1,8	5°				6110	laminát	B-29480	134,99 €



**ŠPECIÁLNA KONŠTRUKCIA**  
Vynikajúce pre Akku píly – predlžuje výdrž batérie a chráni motor.



**NAJLEPŠÍ POVRCH**  
Presne brúsené zuby s povrchom ako zrkadlo a ostrejším britom.



**ŠIROKÁ MOŽNOSŤ POUŽITIA**  
Kotúče vhodné pre širokú škálu možného použitia.

# DELENIE: PÍLOVÉ KOTUČE

Ø kotúča (mm)	ID kód	hrúbka zubu (mm)	vrtanie (mm)	počet zubov	hrúbka kotúča (mm)	uhol zubu	Ø krúžku (mm)	rez priechny	rez pozdĺžny	max. otáčky (min <sup>-1</sup> )	materiál	Obj. č.	MOC s DPH
<b>Špeciálne kotúče pre akku píly – špeciálne zapustené hrot</b> <span style="float: right;">*****</span>													
165	CSCE16516E	2	20	16	1,25	23°		• •	9 250		drevo	B-33037	44,99 €
165	CSME16524E	2	20	24	1,25	23°		• •	9 250		drevo	B-09391	50,99 €
165	CSME16540E	2	20	40	1,25	18°		• •	9 250		drevo	B-09472	55,99 €
185	CSCE18516G	2	30	16	1,25	25°		• •	8 250		drevo	B-09341	28,99 €
185	CSME18524C	2	15,88	24	1,25	23°		• •	8 250		drevo	B-09400	32,99 €
185	CSME18520G	2	30	20	1,25	25°		• •	8 250		drevo	B-09416	34,99 €
185	CSME18540G	2	30	40	1,25	25°		• •	8 250		drevo	B-09494	50,99 €
190	CSCE19016G	2	30	16	1,25	23°		• •	8 040		drevo	B-09357	30,99 €
190	CSME19024G	2	30	24	1,25	23°		• •	8 040		drevo	B-33118	38,99 €
190	CSME19040G	2	30	40	1,25	23°		• •	8 040		drevo	B-33180	53,99 €
210	CSCE21018G	1,9	30	18	1,4	23°		• •	7 300		drevo	B-33065	34,99 €
235	CSCE23520G	2,3	30	20	1,6	25°		• •	6 500		drevo	B-33071	cena na vyžiadanie
235	CSME23524G	2,3	30	24	1,6	23°		• •	6 500		drevo	B-09444	45,99 €
235	CSME23548G	2,3	30	48	1,6	18°		• •	6 500		drevo	B-33196	92,99 €
270	CSME27024G	2,6	30	24	1,8	23°		• •	5 650		drevo	B-33146	110,99 €

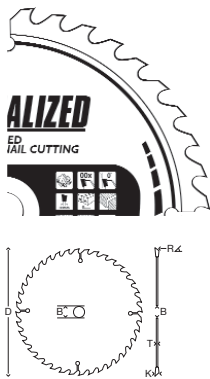

Kotúče so zapustenými hrotmi, alebo „hlbokými zubmi“ sú navrhnuté tak, aby vyhovovali pílam Makita i iných výrobcov. Sú to veľmi pevné kotúče odolné proti opotrebovaniu.

Lahko si poradí s „hrčovitým“ drevom a ani rezanie dreva s klincami alebo skrutkami jeho zuby nepoškodí. Sú obzvlášť vhodné pre použitie na stavebné drevo a demolačné práce. Rezanie klincov a „hrč“.

Extrémne pevný a odolný proti opotrebovaniu. Dlhšia životnosť a zvýšená produktivita.



### CHRÁNENÉ ZUBY

Kotúče so zapustenými hrotmi alebo hlbokými zubmi majú veľmi silnú väzbu medzi telom listu a hrotom TCT.



### VYSOKÉ NÁROKY

Zvlášť vhodné na bednenie a iné náročné práce. Vynikajúce na rezanie dreva s „hrčami“ a klincami.

## DELENIE: PÍLOVÉ KOTUČE

Ø kotúča (mm)	ID kód	hrúbka zubu (mm)	vrtanie (mm)	počet zubov	hrúbka kotúča (mm)	uhol zubu	Ø kružku (mm)	rez priechy	rez pozdĺžny	max. otáčky (min <sup>-1</sup> )	materiál	Obj. č.	MOC s DPH
<b>Špeciálne kotúče na rezanie hliníka pre kotúčové, pokosové a stolné píly</b> <span style="float: right;">*****</span>													
160	CSA16060E	2,4	20	58	1,8	0°				9 540	hliník	B-33233	49,99 €
160	CSA16060G	2,4	30	60	1,8	0°	20			9 540	hliník	B-33249	51,99 €
180	CSA18060G	2,4	30	60	1,8	0°	15,88/20			8 480	hliník	B-09575	55,99 €
190	CSA19060G	2,4	30	60	1,8	0°	15,88/20			8 040	hliník	B-33261	80,99 €
190	MSA19060E	2	20	60	1,4	-5°				8 040	hliník	B-09612	64,99 €
200	TSA20064G	2,8	30	64	2,2	0°				7 630	hliník	B-09690	88,99 €
216	MSA21664G	2,2	30	64	1,6	-5°				7 070	hliník	B-33299	76,99 €
235	CSA23580G	2,4	30	80	1,8	0°				6 500	hliník	B-09606	81,99 €
250	MSA25080G	2,4	30	80	1,8	-5°				6 110	hliník	B-33308	81,99 €
250	TSA25080G	2,8	30	80	2,2	0°				6 110	hliník	B-33370	122,99 €
250	MSA250100G	2,4	30	100	1,8	-5°				6 110	hliník	B-33314	88,99 €
260	MSA26080G	2,3	30	80	1,8	-5°				5 870	hliník	B-33320	81,99 €
260	TSA26080G	2,8	30	80	2,2	0°				5 870	hliník	B-09715	116,99 €
260	MSA260100G	2,3	30	100	1,8	-5°				5 870	hliník	B-33336	91,99 €
300	TSA30080G	2,8	30	80	2,2	0°				5 090	hliník	B-09721	120,99 €
305	MSA30580G	2,3	30	80	1,8	-5°				5 000	hliník	B-33342	122,99 €
305	MSA305100G	2,3	30	100	1,8	-5°				5 000	hliník	B-33358	123,99 €
355	TSA355120G	3	30	120	2,4	-5°				4 360	hliník	B-12522	190,99 €

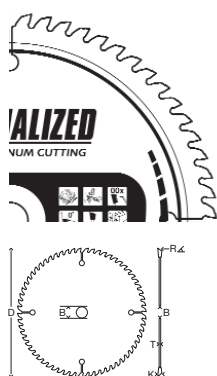

Rada kotúčov pre ručné, pokosové a stolné píly s vynikajúcim rezným výkonom pre hliník, meď, mosadz, bronz a iné farebné kovy. Kotúče sú vhodné aj k práci s plastmi a laminovaným drevom.

Pri rezaní farebných kovov je treba na hroty používať mazivo, aby sa v drážkach kotúča nehromadili triesky.

Presne vystužené kotúče pre plochšie brity a rovnejšie rezy.

Vynikajúca kvalita rezu farebných kovových materiálov.

Špičkový výkon pri laminátových podlahových materiáloch.

Ø kotúča (mm)	ID kód	hrúbka zubu (mm)	vrtanie (mm)	počet zubov	hrúbka kotúča (mm)	uhol zubu	tvár zubu	max. otáčky (min <sup>-1</sup> )	materiál	Obj. č.	MOC s DPH
<b>Pílové kotúče na hliník</b> <span style="float: right;">***</span>											
185		2,2	30	40	1,4	5°	TCG	8300	hliník	D-62103	12,99 €
190		2,2	30	60	1,4	5°	TCG	8040	hliník	D-72970	21,99 €
235		2,4	30	80	1,6	5°	TCG	6550	hliník	D-72992	31,99 €
260		2,8	30	70	1,8	5°	TCG	5870	hliník	D-73003	35,99 €
260		2,6	30	100	1,8	5°	TCG	5870	hliník	D-61874	34,99 €
260		2,6	30	120	1,8	5°	TCG	5870	hliník	D-61880	38,99 €



### PERFEKTNÝ PROFIL

Zuby so špeciálnym profilom pre farebné kovy.



### MÁLO TRIESOK

Pri použití na laminátové podlahové materiály vytvára málo triesok a odštiepkov.

## DELENIE: PÍLOVÉ KOTUČE

Ø kotúča (mm)	ID kód	hrúbka zubu (mm)	vrtanie (mm)	počet zubov	hrúbka kotúča (mm)	uhol zubu	Ø kružku (mm)	rez priechny	rez pozdĺžny	max. otáčky (min <sup>-1</sup> )	materiál	Obj. č.	MOC s DPH
<b>špeciálne kotúče na rezanie kovov pre kotúčové a skracovacie píly</b>													
185	MCS18536G	1,9	30	36	1,5	0°				5 800	mäkká oceľ	B-33417	91,99 €
185	MCS18538G	2	30	38	1,6	0°				5 800	mäkká oceľ	B-33423	79,99 €
185	MCS18548G	2	30	48	1,6	0°				5 800	mäkká oceľ	B-33451	87,99 €
185	MCS18570G	1,7	30	70	1,3	-10°				5 800	plech	B-09771	82,99 €
305	MCS30560F	2,1	25,4	60	1,7	0°				2 000	mäkká oceľ	B-33439	170,99 €
305	MCS30578F	2,3	25,4	78	2	-5°				2 000	tenká mäkká oceľ	B-09793	227,99 €

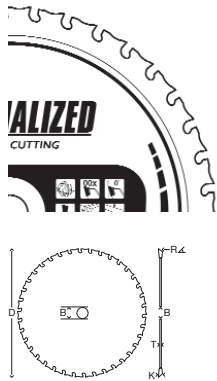

Rada pílových kotúčov Makita na rezanie ocele konštruovaných tak, aby bol rez čistejší a rýchlejší. Predovšetkým vďaka zloženiu karbidu a špeciálnej konštrukcii hrotov sú tieto kotúče odolné proti nárazom a majú dlhú životnosť pri rezaní mäkkej oceli, plechu, potrubia, profilov alebo závitových tyčí.

Kotúče Makita zaisťujú rýchlejší a čistejší rez, pričom vydržia až 30 krát dlhšie ako klasické rezné kotúče. Presne nabrúsené hroty so špeciálnym zložením karbidu pre rýchle a čisté rezy. Malá iskrivosť a minimálna tvorba prachu. Menšie náklady na rez.

## Špeciálne kotúče pre ponorné píly

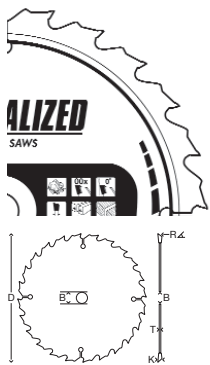

Kotúče konštruované špeciálne pre ponorné píly sú určené na rezanie dreva a hliníku. Majú zvláštnu konštrukciu zaisťujúcu hladký a čistý rez. Kotúče pre ponorné píly majú podobnú špecifikáciu ako Premium MakBlade Plus s patentovanou technológiou eliminujúcou vibrácie. Práca s kotúčmi s nízkymi vibráciami je presnejšia pri menšom hádzaní a ľahko sa ponorí do materiálu pri vynaložení malého úsilia. Špeciálna antivibračná konštrukcia. Presne vystužené kotúče s plochejšími britmi pre perfektne rovné rezy. K dispozícii kotúče na rezanie dreva a hliníku.



## Pílové kotúče pre ponorné píly

<b>Pílové kotúče pre ponorné píly</b>												
160	CSP16028E	2,2	20	28	1,6	23°		• •	9 540	drevo	B-09260	44,99 €
160	CSP16048E	2,2	20	48	1,6	8°		• •	9 540	drevo	B-32998	59,99 €
165	CSP16528E	2,2	20	28	1,6	23°		• •	9 250	drevo	B-33009	54,99 €
165	CSP16548E	2,2	20	48	1,6	8°		• •	9 250	drevo	B-33015	70,99 €
165	CSPX16556E	2,4	20	56	1,7	-3°		• •	9 250	hliník	B-33021	92,99 €

## DELENIE: PÍLOVÉ KOTÚČE

Ø kotúča (mm)	ID kód	hrúbka rezu (mm)	vrtanie (mm)	počet zubov	hrúbka kotúča (mm)	uhol zubu	tvar zubu	max. otáčky (min <sup>-1</sup> )	materiál	Obj. č.	MOC s DPH
<b>Špeciálne pílové kotúče na vlákno cementové a cementové dosky</b> *****											
165	CSC1654EPCD	2,1	20	4	1,4	10°			cementové dosky	B-33685	70,99 €
190	CSC1904GPCD	2,1	30	4	1,4	10°			cementové dosky	B-23008	66,99 €

Ako jeden z rastúcich ekologických materiálov v stavebníctve si vyžaduje vlákno-cementová doska dokonalý pílový kotúč a práve ten vytvorila spoločnosť Makita.

Sortiment pílových kotúčov PCD od spoločnosti Makita bol navrhnutý tak, aby poskytoval vynikajúci výkon pri rezaní vlákno-cementových dosiek vrátane dosiek „Hardy Board“, „Marley Weatherboard“ a lisovaného betónu.

<b>Špeciálne kotúče na rezanie sendvičových panelov pre kotúčové píly</b> *****											
165	CSF16542EL	1,75	20	45	1,4	0°		9250	sendvič. panel	B-63149	78,99 €
235	CSF23550GL	2,4	30	50	1,8	0°		6 500	sendvič. panel	B-33582	115,99 €
235	CSF23550GL	2,4	30	50	1,8	0°	SMTCG	6500	sendvič. panel	B-33582	115,99 €
270	CSF27060GL	2,6	30	60	2,0	0°		5 650	sendvič. panel	B-33598	171,99 €
355	CSF35580GL	3,2	30	80	2,6	0°		4 300	sendvič. panel	B-33607	210,99 €

Pílové kotúče vyrobené špeciálne pre rezanie sendvičových panelov. Extrémne pevné a odolné proti opotrebeniu, dlhá životnosť a produktivita.

<b>Špeciálne pílové kotúče konstrukt pre kotúčové píly</b> *****											
190	CSCE19012G	2,6	30	12	1,6	20°			drevo	B-33554	34,99 €
235	CSCE23516G	3,0	30	16	2,6	20°			drevo	B-13699	39,99 €

Špeciálna konštrukcia zubov týchto pílových kotúčov umožňuje rezať stavebné drevo s klinkami. Extrémne pevné a odolné proti opotrebeniu, dlhá životnosť a produktivita.

<b>Pílové kotúče pre pokosové a kotúčové píly</b> *****											
190		2,2	30	24	1,4	15°		8040	drevo	D-64951	10,19 €
190		2	30	40	1,3	18°		8040	drevo	D-64973	13,99 €
260		2,6	30	40	1,8	15°		5870	drevo	D-65377	18,99 €
260		2,6	30	60	1,8	15°		5870	drevo	D-65383	22,99 €
260		2,6	30	80	1,8	12°		5870	drevo	D-65399	28,99 €
260		2,6	30	100	1,8	12°		5870	drevo	D-65408	31,99 €

### Redukčné krúžky pre pílové kotúče



parametre	obj. č.	MOC s DPH
20 mm × 15,88 mm × 1,2 mm	B-20987	2,49 €
20 mm × 15,88 mm × 1,8 mm	B-20993	2,39 €
30 mm × 15,88 mm × 1,2 mm	B-21004	2,29 €
30 mm × 15,88 mm × 1,8 mm	B-21010	2,79 €
30 mm × 20 mm × 1,2 mm	B-21026	2,49 €
30 mm × 20 mm × 1,4 mm	B-21032	2,59 €
30 mm × 20 mm × 1,8 mm	B-21048	2,49 €
30 mm × 25 mm × 1,6 mm	B-21054	2,79 €
30 mm × 25,4 mm × 1,4 mm	B-21060	2,79 €
30 mm × 25,4 mm × 2,2 mm	B-21076	2,49 €

# DELENIE: PRÍSLUŠENSTVO PRE KOTUČOVÉ PONORNÉ A POKOSOVÉ PÍLY

	model	Obj. č.	MOC s DPH
<b>Paralelný doraz</b> <span style="float: right;">*****</span>			
	DCS550, DCS551, DCS553, DHS630, DHS660, DHS661, DHS680, DHS710, DHS711, DHS782, DHS783, DSS500, DSS501, DSS610, DSS611, 4191D, 5093D, 5094D, HS300D, 5005BA, 5007F, 5007FA, 5007MG, 5007MGA, 5007N, 5007NB, 5007NF, 5008MG, 5008MGA, 5606B, 5704R, 5740NB, 5800NB, 5806B, HS6100, HS6101, HS6600, HS6601, HS7000, HS7010, HS7100, HS7101, HS7600, HS7601, HS7610, HS7611, HS004G	164095-8	2,09 €
	DSP600, DSP601, SP6000	165447-6	13,99 €
	5017RKB, 5705R	165108-8	7,99 €
	HS0600, N5900B, 5902B,	164367-1	2,89 €
	5103R, 5104, 5104S, 5903R	165084-6	3,99 €
<b>Adaptér odsávací</b>			
	5603R, 5704R, 5705R/RK	192420-3	3,19 €
	DHS660, DHS661	199230-9	1,39 €
	DHS680	196961-1	1,39 €
	DHS710, DHS780, DHS781, DHS782, DHS783, HS003G, HS004G	196520-1	2,59 €
	HS6600, HS6601, HS7000, HS7010, HS7601, HS7610, HS7611		
	DHS711, HS6600	196843-7	2,99 €
	5103R	415426-7	2,39 €
<b>Vak na prach</b>			
	SP6000	122562-9	15,99 €
	DSP600, DSP601	126599-8	13,99 €
<b>Vodiace lišty</b> <span style="float: right;">*****</span>			
	1000 mm	199140-0	54,99 €
	1500 mm	199141-8	71,99 €
	3000 mm	194367-7	180,99 €
	spojka vodiacej lišty (sada 2 ks)	198885-7	26,99 €
	<b>Náhradné gumeny pre vodiace lišty</b>		
	gumenný samolepiaci pás (1) na lištu 1400 mm	413101-9	2,44 €
	gumenný samolepiaci pás (2) na lištu 1400 mm	423359-2	4,40 €
	penový samolepiaci pás (3) na lištu 1400 mm	423361-5	4,40 €
	gumenný samolepiaci pás (1) na lištu 1900 mm	451330-6	3,02 €
	gumenný samolepiaci pás (2) na lištu 1900 mm	423386-9	6,09 €
	penový samolepiaci pás (3) na lištu 1900 mm	423390-8	6,03 €
	gumenný samolepiaci pás (1) na lištu 3000 mm	413102-7	5,07 €
	gumenný samolepiaci pás (2) na lištu 3000 mm	423360-7	9,47 €
	penový samolepiaci pás (3) na lištu 3000 mm	423362-3	9,47 €
<b>Upínacie svorky</b>			
	skrutková svorka (sada 2 ks)	194385-5	39,99 €
	quick systém svorka (sada 2 ks)	199826-6	102,99 €
<b>Uhlový adaptér k vodiacej lište</b>			
		196664-7	45,99 €
<b>Hák na zavesenie</b>			
	DHS660, DHS661	199231-7	9,34 €
	DHS782, DHS783, HS003G, HS004G	199386-8	16,99 €

# DELENIE: PÍLOVÉ KOTÚČE

## Adaptéry pre vodiace lišty Makita

Adapér	A	B	C	D	E	F (N)	G	H	I	J	K	L	M	N (F)	O	P	Q	R	
	Kotúčové píly													Prímočiarié píly		Frézy	Píly		
Model			HS7601 HS7610 HS7611	DHS680 HS012G	HS6600 HS6601	DHS630 DHS710 DHS711 HS6100 HS6101 HS7100 HS7101	HS0600	5603 5703 5705R	DHS660 DHS661				5903R	5103R	DJV141, DJV142, DJV180, DJV181, DJV182	DJV141 DJV142 DJV180 DJV181 DJV182		*DRT50 3612BR RP0900 RP0910 RP1110C RP1800 RP1800F RP1801 RP1801F RP2300FC RP2301F *RT001G *RT0702C RP1803F RP2303FC	DCC500 DCC501 4100KB, 4100NH2
Obj. č.			197005-0	196953-0	197462-2	197252-3	198570-2	192505-5	199232-5				192506-3	192507-1	197252-3	193517-1		194579-2	198673-2
MOC s DPH			20,99 €	53,99 €	25,99 €	89,99 €	243,99 €	32,99 €	51,99 €				154,99 €	117,99 €	89,99 €	25,99 €		41,99 €	27,99 €

\* s použitím základne 195563-0

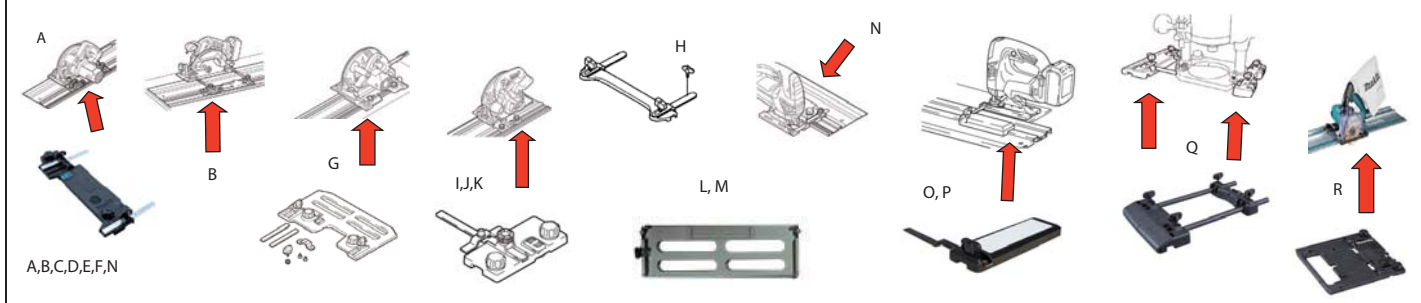

Modely píľ priame pripojenie bez použitia adaptéra na vodiacu lištu  
 SP6000, DHS900, DHS783, DHS782, DSP601, DSP600, HS004G, HS009G, HS011G, SP001G

Modely píľ ktoré sa nedajú použiť s adaptérom na vodiacu lištu  
 5604, 5704, 5143R, N5900B, 5104S, DRS780, DSS610, RS001G, RS002G, CS002G

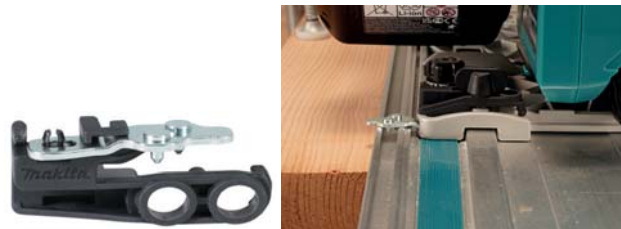

## Špeciálne príslušenstvo k vodiacím lištám

popis	obj. č.	MOC s DPH
Stop doraz , vhodné pre modely píľ: HS900, HS009G, HS011, SP001, SP600, SP601D CA5000, HS782, HS783D, HS004, SP6000	1913J9-2	5,59 €
Svorka upínacia s dorazom	1913K5-7	45,99 €
Paralélny doraz pre vodiace lišty s pravítkom	1913K7-3	cena na vyžiadanie







# DELENIE: PRÍSLUŠENSTVO PRE STOLNÉ A POKOSOVÉ PÍLY

	model	Obj. č.	MOC s DPH
<b>Vak na prach</b> 			
	LF1000, LH1040/F, LS0714/F/FL/L, LS1019/L, LS1030N, LS1040/F, LS1045, LS1216/F/FL/L, LS1219/L, LS1221, DLS111, DLS211, LS003g, LS004G, MLS100	122852-0	3,69 €
	LH1201FL, LS1017L, LS1018L	JM23100501	4,99 €
	LS0815F/FL	JM23510010	5,49 €
	LS1440	122330-0	18,99 €
	LS0810, LS1020, LS1030	122351-2	6,39 €
	LS002G	127512-9	cena na vyžiadanie
	uzáver vaku na prach	410602-8	0,62 €

<b>Svorka zvislá</b>			
	DLS713, DLS714, LS0714, LS0714F, LS0714FL, LS0714L	122571-8	11,99 €
	DLS110, DLS111, DLS112, LS1019/L, LS1219/L, LS003G, LS004G	126617-2	24,99 €
	LS1017L, LS1018L, LH1201FL	JM23100502	8,09 €
	LS1040, LS1040F, LH1040, LH1040F	122536-0	11,99 €
	LS1013	122538-6	9,99 €
	LS1016L, LS1216L	122854-6	26,99 €

<b>Svorka vodorovná</b>			
	LS1017L, LS1018L	122930-6	102,99 €

<b>Predženie stola</b>			
	DLS110, DLS111, DLS112, LS1019/L	326978-2	6,14 €
	LS1018L, LH1201FL	JM23100500	9,99 €
	LS1040, LS1040F, LH1040/F	123101-8	18,00 €
	LS1219, LS1219L, LS004G, DSL111	327095-1	9,47 €

<b>Uhlový doraz</b>			
	LF1000	122730-4	17,99 €
	2704	127069-0	60,99 €
	2712	JM27110005	40,99 €







<b>Vodiaci doraz</b>			
	LF1000	122729-9	36,99 €
	LH1040/F	122707-9	11,99 €
	LH1200, LH1201	JM23300008	56,99 €

<b>Hadica odsávania</b>			
	LS1019L	123980-4	77,51 €
	LS1219L	126792-4	33,91 €

<b>Ostatné príslušenstvo</b>			
	tyč pre posun materiálu	JM21080290	1,29 €
	žiarovka pre všetky pokosové píly s označením f	193730-1	6,98 €
	nastavovací trojuholník	762001-3	0,69 €

<b>Príslušenstvo pre 2704</b>			
	popis	obj. č.	Moc s DPH
	1. vodiaci doraz	122739-6	183,99 €
	2. predženie stola vzadu	194087-3	61,99 €
	3. predženie stola vľavo	194086-5	58,99 €

# DELENIE: PRÍSLUŠENSTVO PRE STOLNÉ A POKOSOVÉ PÍLY

Stôl	model	Obj. č.	MOC s DPH
	LS0714, LS1040, LH1040, LS1013, LS1016, LS108, LS1214, LS1440, 2012NB	198688-9	272,99 €
	2703, 2704, 2704N, 2705	194093-8	603,99 €
	MLT100, MLT100N,	JM27000300	428,99 €
	pre všetky modely stolných a pokosových píľ okrem 2704,LF100	DEAWST05	414,99 €
	pre všetky modely stolných a pokosových píľ okrem 2704,LF100 1170/2700 x 500 x 550/800 mm	DEBWST06	354,99 €
	pre všetky modely stolných a pokosových píľ okrem 2704,LF100 1765/3830 x 750 x 860 mm	DEAWST07	493,99 €
	lišta upínacia pre stoly WST06, WST07	JM23610050	94,99 €

# PRÍSLUŠENSTVO

## ▣ Priamočiare a chvostové píly

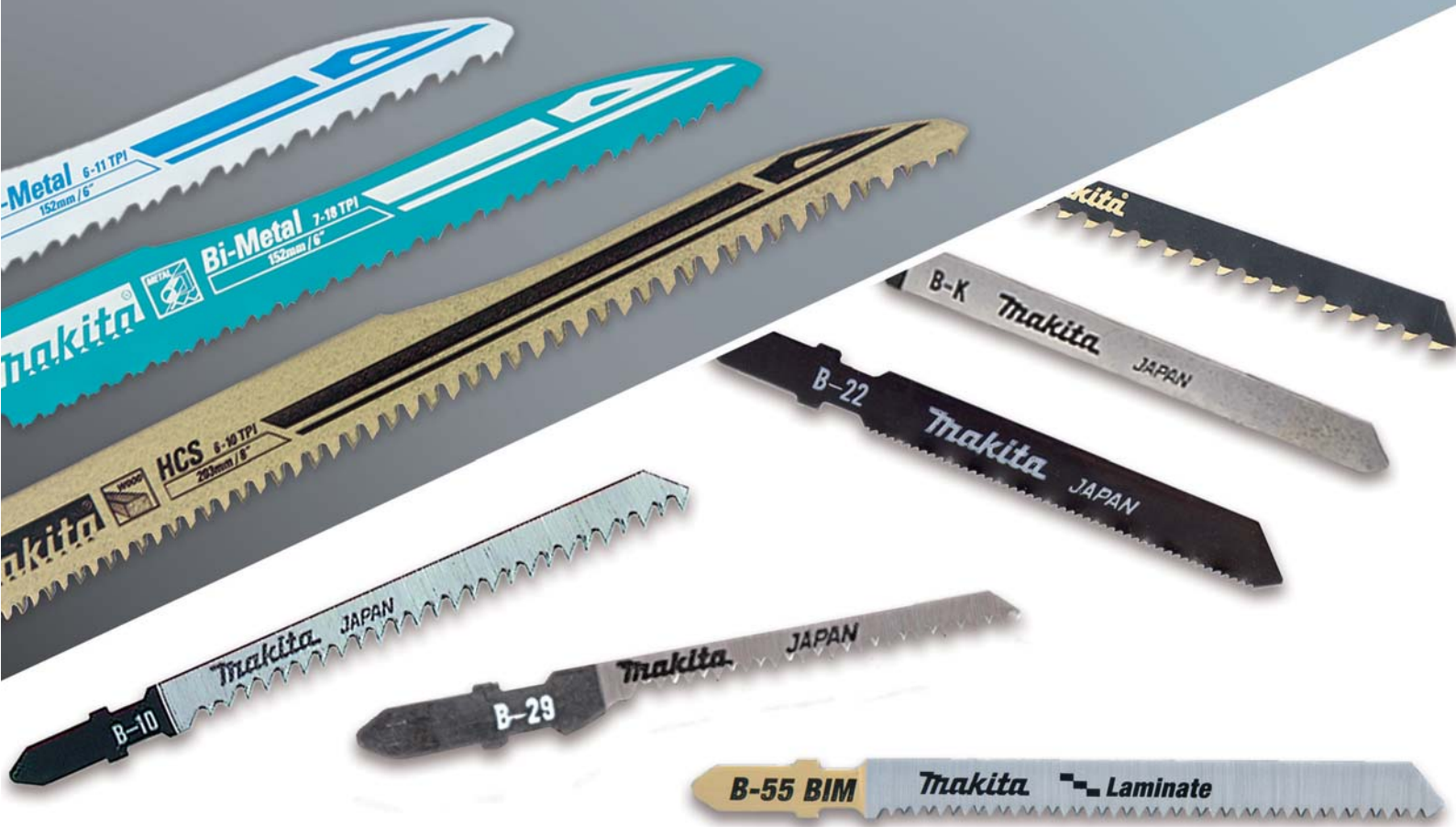

Kov, mäkká oceľ



Neželezné kovy



Laminátové podlahy



Sklolaminát



Nerez



Drevo



Vláknocementová doska



Sadrokartón



Liatina



Drevo s klincami



Pórobetón



HCS



Hliník



Drevotrieska



PVC



Bi-Metal

## Typ zubu

frézované bočné zuby

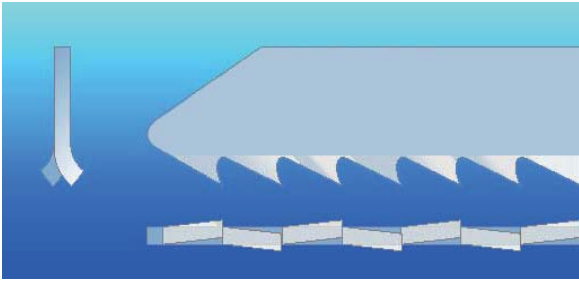

pozdlžne a bočné zuby

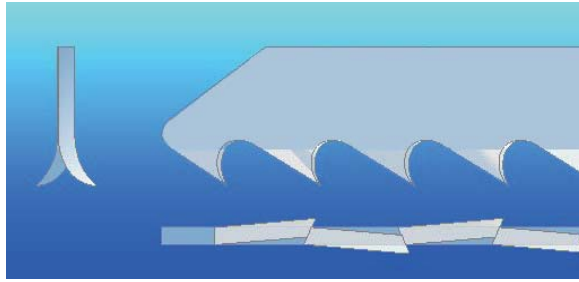

frézované vlnité zuby

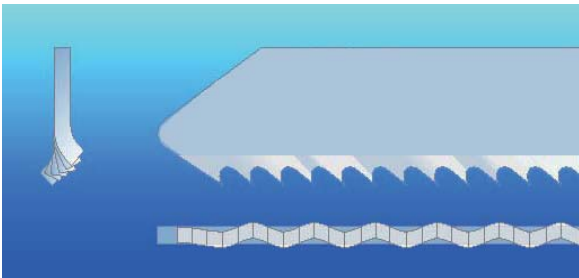

tvrdé kuželovité zuby

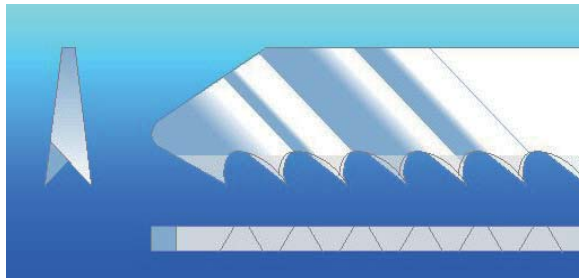

### frézované zuby

- pre bežné rezanie
- mäkké až tvrdé materiály
- dlhá životnosť



### tvrdé zuby

- veľmi ostré zuby
- presný a čistý rez
- mäkké až stredne tvrdé materiály



## Spôsob výroby

- **bočné zuby:** každý jednotlivý zub je striedavo ohnutý doľava a doprava. Príklad: pravá, ľavá, rovná atď.
- **vlnité zuby:** zuby sú tvarované do vlnovky
- **tvrdé zuby:** teleso čepele sa zužuje smerom dozadu (kuželovité)

bočné zuby

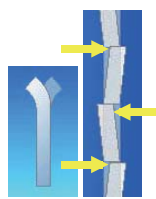

vlnité zuby

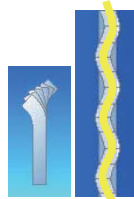

tvrdé zuby



## Použitie materiály na výrobu pílových listov

- **HCS (ocel' s vysokým obsahom uhlíka)** na rezanie mäkkších materiálov, ako je drevo alebo plasty.
- **HSS (rýchlorezná ocel)** na rezanie tvrdších materiálov, ako sú kovy.
- **BiM (dvojkov /HCS a HSS/)** na rezanie mäkkých materiálov a tvrdých materiálov ako drevo, kovy, plasty.
- **TC (karbid volfrámu)** na rezanie plastov vystužených sklenenými vláknami, cementovo viazaných drevovláknitých dosiek alebo sadrokartónu.

## List priamočiarej píly B stopka, Drevo Super express



**SUPEREXPRESS**



Rozsah	Makita č.	Materiál	Typ rezu	Typ zuby	TPI	Celková dĺžka mm	Pracovná dĺžka mm	Hrúbka listu mm	Materiál listu	Ks / bal.	Obj. č.	MOC s DPH
★★★☆☆	B-50	Drevo, PVC	Rýchly a čistý	Kuželovité brúsené zuby	8-11	100	73	1.25	HCS	5	B-06460	6,89 €

## List priamočiarej píly B stopka, Kov Super express



**SUPEREXPRESS**



Rozsah	Makita č.	Materiál	Typ rezu	Typ zuby	TPI	Celková dĺžka mm	Pracovná dĺžka mm	Hrúbka listu mm	Materiál listu	Ks / bal.	Obj. č.	MOC s DPH
★★★☆☆	B-51	Kov, Nerez	Rýchly	Frézované vlnité zuby	10-18	100	73	0.8	HSS	5	B-06476	7,69 €

## List priamočiarej píly B stopka, Univerzálny Super express



**SUPEREXPRESS**



Rozsah	Makita č.	Materiál	Typ rezu	Typ zuby	TPI	Celková dĺžka mm	Pracovná dĺžka mm	Hrúbka listu mm	Materiál listu	Ks / bal.	Obj. č.	MOC s DPH
★★★☆☆	B-52	Univerzálny	Rýchly	Frézované vlnité zuby	6-10	100	73	1.0	HSS	5	B-06482	7,99 €

## List priamočiarej píly B stopka, Drevo štandardný rez



Rozsah	Makita č.	Materiál	Typ rezu	Typ zuby	TPI	Celková dĺžka mm	Pracovná dĺžka mm	Hrúbka listu mm	Materiál listu	Ks / bal.	Obj. č.	MOC s DPH
★★★☆☆	B-13	Drevo, PVC	Štandardný	Frézované bočne vsadené zuby	8	105	75	1.25	HCS	5	A-85656	3,89 €
	B-14		Štandardný		18	76	51	1.05	HCS	5	A-85662	3,79 €
	B-15		Štandardný		12	76	50	1.05	HCS	5	A-85678	3,79 €
	B-18		Štandardný, Oblúkový		14	77	44	1.05	HCS	5	A-85709	3,59 €

## List priamočiarej píly B stopka, Drevo rýchly rez

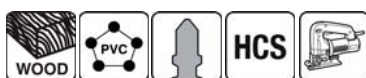

Rozsah	Makita č.	Materiál	Typ rezu	Typ zuby	TPI	Celková dĺžka mm	Pracovná dĺžka mm	Hrúbka listu mm	Materiál listu	Ks / bal.	Obj. č.	MOC s DPH
★★★☆☆	B-16	Drevo, PVC	Rýchly	Brúsené bočne vsadené zuby	6	105	75	1.25	HCS	5	A-85684	4,69 €
	B-17		Rýchly, Oblúkový		6	105	71	1.25		100	B-07711	92,99 €
	B-8		Rýchly		8	105	75	1.25		5	A-85232	5,49 €
	L-2		Rýchly		6	132	101	1.25		5	A-86309	7,29 €
	L-10		Štandardný		7	180	155	1.25		5	A-86315	8,79 €

## DELENIE: PÍLOVÉ LISTY

### List priamočiarej píly B stopka, Drevo čistý rez



Rozsah	Makita č.	Materiál	Typ rezu	Typ zubu	TPI	Celková dĺžka mm	Pracovná dĺžka mm	Hrúbka listu mm	Materiál listu	Ks / bal.	Obj. č.		
★★★★☆	B-10	Drevo, PVC	Rýchly a čistý	Kuželovité brúsené zuby	9	105	76	1.25	HCS	5	A-85628	5,39 €	
					100							100	B-07674
	B-11				5	A-85634	5,59 €						
					100	B-07680	113,99 €						
	B-12				5	A-85640	5,39 €						
					100	B-07696	120,99 €						
	L-1		Čistý	Frézované bočne vsadenené zuby	6	132	100	1.25	HCS	5	A-86290	9,09 €	
					BR-13	5	A-85793	4,09 €					
						100	B-07777	81,99 €					
						Drevo	Rýchly rez, oblúkový	Kuželovité brúsené zuby	6,35	100	75	1,25	
	Drevo s klincami, kov	Rýchly rez	Frézované vlnité zuby	10	100	75	1,25	Bi-Metal	5	B-49622	cena na vyžiadanie		

### List priamočiarej píly B stopka, Tvrdé drevo a tvrdé plasty, štandardný rez

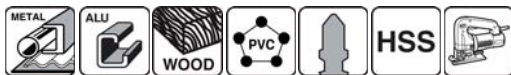

Rozsah	Makita č.	Materiál	Typ rezu	Typ zubu	TPI	Celková dĺžka mm	Pracovná dĺžka mm	Hrúbka listu mm	Materiál listu	Ks / bal.	Obj. č.	MOC s DPH
★★★★☆	B-25	Drevo, PVC, Hliník, Kov	Štandardný	Frézované bočne vsadenené zuby	9	100	74	1.05	HSS	5	A-85765	5,79 €
					100							100
	B-26	Drevo, PVC, Hliník, Kov	Štandardný, Oblúkový	Frézované bočne vsadenené zuby	9	100	71	1.05	HSS	5	A-85771	6,69 €

### List priamočiarej píly B stopka, Dekoratívne dyhy čistý rez

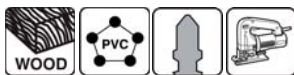

Rozsah	Makita č.	Materiál	Typ rezu	Typ zubu	TPI	Celková dĺžka mm	Pracovná dĺžka mm	Hrúbka listu mm	Materiál listu	Ks / bal.	Obj. č.	MOC s DPH
★★★★☆	B-19	Drevo, PVC	Čistý	Kuželovité brúsené zuby	12	90	63	1.25	HCS	5	A-85715	5,29 €

### List priamočiarej píly B stopka, Laminátové podlahy čistý rez

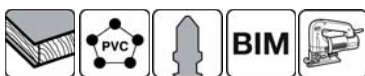

Rozsah	Makita č.	Materiál	Typ rezu	Typ zubu	TPI	Celková dĺžka mm	Pracovná dĺžka mm	Hrúbka listu mm	Materiál listu	Ks / bal.	Obj. č.	MOC s DPH
★★★★☆	B-53	Laminátové podlahy, PVC	Čistý	Kuželovité brúsené zuby	15	82	59	1.25	Bi-Metal	5	B-10970	13,99 €
	B-54		Čistý, Oblúkový		18	82	59	1.25	Bi-Metal	5	B-10986	15,99 €
	B-55		Čistý		14	100	77	1.25	Bi-Metal	5	B-31887	13,99 €
			Čistý rýchly rez		13	85	60	1,35	Bi-Metal	5	P-31566	11,99 €

### List priamočiarej píly B stopka, Sklo, keramika, fibrové sklo, hrubý rez

Rozsah	Makita č.	Materiál	Typ rezu	Typ zubu	TPI	Celková dĺžka mm	Pracovná dĺžka mm	Hrúbka listu mm	Materiál listu	Ks / bal.	Obj. č.	MOC s DPH
★★★★☆		Sklo, keramika, fibrové sklo	Hrubý rez	-	-	70	54		HM / TC Griff	3	P-38788	15,99 €

## Pílové listy pre DSD180 / SD100



Rozsah	Makita č.	Materiál	Typ rezu	Typ zubu	TPI	Celková dĺžka mm	Pracovná dĺžka mm	Hrúbka listu mm	Materiál listu	Ks / bal.	Obj. č.	MOC s DPH
★★★★★		Pílový list na sádrokartón				55	0,55	18	HCS	2	B-49703	19,99 €
		Pílový list na drevo				55	0,55	18	HCS	2	B-49719	27,99 €

## List priamočiarej píly B stopka, Kov štandardný rez



Rozsah	Makita č.	Materiál	Typ rezu	Typ zubu	TPI	Celková dĺžka mm	Pracovná dĺžka mm	Hrúbka listu mm	Materiál listu	Ks / bal.	Obj. č.	MOC s DPH		
★★★☆☆	B-22	Kov, Nerez, PVC, Hliník	Štandardný	Frézované vlnité zuby	24	75	50	1,25	TCT	1	P-05929	17,99 €		
		Kov, Nerez, PVC, Hliník			24	76	52	0.9	HSS	5	A-85737	4,69 €		
	B-23	Drevo, PVC, Hliník, Kov			14	76	51	0.9	HSS	5	A-85743	4,59 €		
	B-24	Kov, Nerez, PVC, Hliník			32	76	52	0.9	HSS	5	A-85759	4,69 €		
	B-30	Kov, Nerez, PVC, Hliník			24	76	52	0,9	HSS	5	B-04961	5,29 €		
		Kov, Nerez, PVC, Hliník, sendvičové panely			24	180	155		Bi-Metal	5	P-49644	13,99 €		
		Kov, sendvičové panely			25	130	105		Bi-Metal	5	P-47204	10,99 €		
	B-27	Kov, Nerez, PVC, Hliník			24	76	52	0.9	HSS	5	A-85787	5,29 €		
	B-27	Kov, Nerez, PVC, Hliník			Štandardný, Oblúkový									

## List priamočiarej píly B stopka, PVC

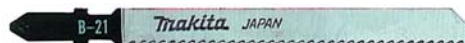
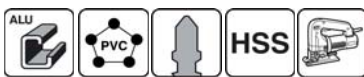

Rozsah	Makita č.	Materiál	TPI	Celková dĺžka mm	Pracovná dĺžka mm	Hrúbka listu mm	Materiál listu	Ks / bal.	Obj. č.	MOC s DPH
★★★☆☆	B-21	PVC, Hliník	12	100	73	1.25	HSS	5	A-85721	8,49 €

## List priamočiarej píly B stopka, Vláknocementové dosky



Rozsah	Makita č.	Materiál	TPI	Celková dĺžka mm	Pracovná dĺžka mm	Hrúbka listu mm	Materiál listu	Ks / bal.	Obj. č.	MOC s DPH
★★★☆☆	B-60	Vláknocementové dosky, Sádrokartón, Sklolaminát, PVC	6	100	75	1.25	TC/HM	3	B-06890	24,99 €
	B-61	Vláknocementové dosky, Sádrokartón, Sklolaminát, PVC	6	132	105	1.25	TC/HM	3	B-06909	35,99 €

## List priamočiarej píly B stopka, Guma



Rozsah	Makita č.	Materiál	Celková dĺžka mm	Pracovná dĺžka mm	Hrúbka listu mm	Materiál listu	Ks / bal.	Obj. č.	MOC s DPH
★★★☆☆	B-K	Guma, Papier, Korok, Koža	100	75	1.25	HCS	5	A-80416	20,99 €

## DELENIE: PÍLOVÉ LISTY

### List priamočiarej píly B stopka, Sady



Rozsah	Obsah sady	Ks / bal.	Obj. č.	MOC s DPH
★★★★☆	B-10S, B-13, B-16, B-22, B-23	5	A-86898	4,59 €
★★★★☆	B-50, B-51, B-52	3	B-06292	5,09 €



### List priamočiarej píly Makita stopka, Drevo štandardný rez

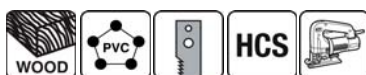

Rozsah	Makita č.	Materiál	Typ rezu	Typ zuby	TPI	Celková dĺžka mm	Pracovná dĺžka mm	Hrúbka listu mm	Materiál listu	Ks / bal.	Obj. č.	MOC s DPH
★★★★☆	No.3	Drevo, PVC	Štandardný	Frézované bočne vsadenené zuby	9	80	59	1	HCS	5	A-85868	4,09 €

### List priamočiarej píly Makita stopka, Drevo čistý rez



Rozsah	Makita č.	Materiál	Typ rezu	Typ zuby	TPI	Celková dĺžka mm	Pracovná dĺžka mm	Hrúbka listu mm	Materiál listu	Ks / bal.	Obj. č.	MOC s DPH
★★★★☆	BR-3	Drevo	Čistý	Frézované bočne vsadenené zuby	9	85	58	1	HCS	5	A-85933	4,59 €
	Č.10	Drevo, PVC	Rýchly a čistý	Kuželovité brúsené zuby	9	82	60	1.25	HCS	5	A-85818	5,99 €

### List priamočiarej píly Makita stopka, Dekoratívne dýhy



Rozsah	Makita č.	Materiál	Typ rezu	Typ zuby	TPI	Celková dĺžka mm	Pracovná dĺžka mm	Hrúbka listu mm	Materiál listu	Ks / bal.	Obj. č.	MOC s DPH
★★★★☆	No.17	Drevo, PVC, Hliník, Kov	Štandardný, Oblúkový	Frézované bočne vsadenené zuby	14	82	63	0.9	HSS	5	A-85846	6,39 €

### List priamočiarej píly Makita stopka, Kov štandardný rez

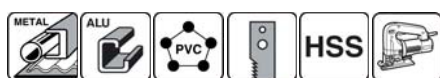

Rozsah	Makita č.	Materiál	Typ rezu	Typ zuby	TPI	Celková dĺžka mm	Pracovná dĺžka mm	Hrúbka listu mm	Materiál listu	Ks / bal.	Obj. č.	MOC s DPH
★★★★☆	No.1	Kov, Nerez, PVC, Hliník	Štandardný	Frézované vlnité zuby	24	80	61	0.9	HSS	5	A-85802	6,09 €

### List pre chvostovú pílu, Kov Super express



Rozsah	Materiál	Typ rezu	Typ zuby	TPI	Celková dĺžka mm	Pracovná dĺžka mm	Hrúbka listu mm	Materiál listu	Ks / bal.	Obj. č.	MOC s DPH
★★★★☆	Kov, PVC	Rýchly	Frézované bočne vsadenené zuby	7-18	152	130	0.9	Bi-Metal	2	B-05038-2	7,39 €
									5	B-05038	16,99 €
									25	B-05038-25	74,99 €



## List pre chvostovú pílu, Drevo Super express



**SUPEREXPRESS**



Rozsah	Materiál	Typ rezu	Typ zubu	TPI	Celková dĺžka mm	Pracovná dĺžka mm	Hrúbka listu mm	Materiál listu	Ks / bal.	Obj. č.	MOC s DPH
★★★★☆	Drevo	Rýchly	Frézované bočne vsadené zuby	6-10	203	180	1.0	HCS	2	B-05153-2	7,69 €
									5	B-05153	17,99 €
									25	B-05153-25	77,99 €

## List pre chvostovú pílu, Univerzál Super express

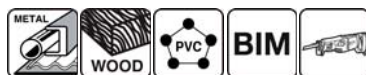

**SUPEREXPRESS**



Rozsah	Materiál	Typ rezu	Typ zubu	TPI	Celková dĺžka mm	Pracovná dĺžka mm	Hrúbka listu mm	Materiál listu	Ks / bal.	Obj. č.	MOC s DPH
★★★★☆	Univerzálny	Rýchly	Frézované bočne vsadené zuby	6-11	152	130	0.9	Bi-Metal	2	B-05044-2	7,39 €
									5	B-05044	16,99 €
									25	B-05044-25	73,99 €

## List pre chvostovú pílu, Kov



Rozsah	Materiál	Typ rezu	Typ zubu	TPI	Celková dĺžka mm	Pracovná dĺžka mm	Hrúbka listu mm	Materiál listu	Ks / bal.	Obj. č.	MOC s DPH
★★★★☆	Kov	Štandardný	Frézované bočne vsadené zuby	14	152	130	0.9	Bi-Metal	2	B-16841-2	5,49 €
				14	225	205	0.9	Bi-Metal	5	B-16841	11,99 €
				14	225	205	0.9	Bi-Metal	2	B-16776-2	8,29 €
				14	225	205	0.9	Bi-Metal	5	B-16776	17,99 €
				18	152	130	0.9	Bi-Metal	2	B-05169-2	5,49 €
				18	165	144	0.9	HSS	5	P-04927	19,99 €
				18	225	205	0.9	Bi-Metal	2	B-16782-2	7,89 €
				18	225	205	0.9	Bi-Metal	5	B-16782	17,99 €
				24	152	130	0.9	Bi-Metal	2	B-16835-2	5,49 €
				24	152	130	0.9	Bi-Metal	5	B-16835	11,99 €
				24	225	205	0.9	Bi-Metal	2	B-43169-2	7,89 €
				14	100	80	0.9	Bi-Metal	5	B-20410	11,99 €
	18	100	80	0.9	Bi-Metal	5	B-20404	11,99 €			
	24	100	80	0.9	Bi-Metal	5	B-20395	11,99 €			
	10-14	305	280	0.9	Bi-Metal	5	B-16857	21,99 €			
	18	100		0.9	Bi-Metal	5	P-04874	13,99 €			
	18	150		0.9	Bi-Metal	5	P-04880	14,99 €			
	24	100		0.9	Bi-Metal	5	P-04896	13,99 €			
	24	150		0.9	Bi-Metal	5	P-04905	14,99 €			
	14	150		0.9	Bi-Metal	5	P-04911	14,99 €			
	14	200		0.9	Bi-Metal	5	P-04927	19,99 €			
	18	200		0.9	Bi-Metal	5	P-04933	19,99 €			
24	200		0.9	Bi-Metal	5	P-04949	19,99 €				
32	150		0.9	Bi-Metal	5	P-04955	15,99 €				
10	280		0.9	Bi-Metal	5	P-04983	23,99 €				

## List pre chvostovú pílu, Kov tvrdé zuby



Rozsah	Materiál	Typ rezu	Typ zubu	TPI	Celková dĺžka mm	Pracovná dĺžka mm	Hrúbka listu mm	Materiál listu	Ks / bal.	Obj. č.	MOC s DPH
★★★★☆	Kov	Tvrдый a rýchly	Frézované bočne vsadené zuby	14+18	225	205	1.1	Bi-Metal	5	B-43175	20,99 €
				8+10	225	205	1.1	Bi-Metal	5	B-43181	20,99 €
				8+10	305	280	1.1	Bi-Metal	2	B-43212-2	10,49 €
				10-14	225	205	1.25	Bi-Metal	2	B-43197-2	9,09 €

## DELENIE: PÍLOVÉ LISTY

### List pre chvostovú pílu, Drevo štandardný rez



Rozsah	Materiál	Typ rezu	Typ zuby	TPI	Celková dĺžka mm	Pracovná dĺžka mm	Hrúbka listu mm	Materiál listu	Ks / bal.	Obj. č.	MOC s DPH
★★★★☆	Drevo	Štandardný	Frézované bočne vsadené zuby	10	152	130	0.8	HCS	5	B-16807	8,79 €
				3	152	130	1.25	HCS	5	B-16813	8,79 €
				6	152	130	1.25	HCS	5	B-16798	8,79 €
				6	305	280	1.25	HCS	2	B-16829-2	6,59 €
				5	305	280	1.25	HCS	5	B-16829	14,99 €
	Green tree, Drevo			5	305	280	1.5	HCS	5	B-16863	20,99 €
	Všetky druhy dreva	Hrubý	Frézované vlnité zuby	4	150		1,2	HCS	5	P-04999	10,99 €
				6	150		1,2	HCS	5	P-05000	10,99 €
		Hrubý, rýchly	Frézované bočne vsadené zuby	6	150		1,3	HCS	5	P-05022	11,99 €
				6	300		1,4	HCS	5	P-05016	16,99 €

### List pre chvostovú pílu, Drevo Rýchly



Rozsah	Materiál	Typ rezu	Typ zuby	TPI	Celková dĺžka mm	Pracovná dĺžka mm	Hrúbka listu mm	Materiál listu	Ks / bal.	Obj. č.	MOC s DPH
★★★★☆	Drevo	Rýchly	Brúsené bočne vsadené zuby	6	300	279	1.25	HCS	5	B-03030	25,99 €

### List pre chvostovú pílu, Drevo a kov štandardný rez



Rozsah	Materiál	Typ rezu	Typ zuby	TPI	Celková dĺžka mm	Pracovná dĺžka mm	Hrúbka listu mm	Materiál listu	Ks / bal.	Obj. č.	MOC s DPH	
★★★★☆	Drevo s kľincami	Štandardný	Frézované bočne vsadené zuby	6	100	80	0.9	Bi-Metal	5	B-20432	12,99 €	
				6	152	130	1.25	Bi-Metal	2	B-05175-2	6,39 €	
				5				Bi-Metal	5	B-05175	13,99 €	
	Drevo, Drevotrieska, Drevo s kľincami, Kov, Pórobetón, PVC, Sklolaminát	Štandardný	Frézované bočne vsadené zuby	5-8	305	280	1.25	Bi-Metal	3	B-10637	15,99 €	
				Drevo, Kov	10	100	80	0.9	Bi-Metal	5	B-20426	11,99 €
					10	152	130	0.9	Bi-Metal	5	B-31843	11,99 €
Drevo, Drevo s kľincami, Kov	10	225	205	0.9	Bi-Metal	5	B-31859	17,99 €				
Drevo, PVC	Štandardný	Frézované vlnité zuby	6	150		1,3	Bi-Metal	5	P-05088	20,99 €		

### List pre chvostovú pílu, Drevo a kov tvrdé zuby



Rozsah	Materiál	Typ rezu	Typ zuby	TPI	Celková dĺžka mm	Pracovná dĺžka mm	Hrúbka listu mm	Materiál listu	Ks / bal.	Obj. č.	MOC s DPH
★★★★☆	Drevo, Drevotrieska, Kov	Heavy	Frézované bočne vsadené zuby	5-8	225	205	1.6	Bi-Metal	2	B-43256-2	11,99 €
				5-8	305	280	1.6	Bi-Metal	2	B-43278-2	13,99 €
	Drevo, PVC, PVC s GRP, sádkartón, vláknocementové dosky	Štandardný	Karbídové zuby	6	90		1,3	HM - TCT	1	P-05038	25,99 €
				6	150		1,3	HM - TCT	1	P-05044	25,99 €
				6	300		1,3	HM - TCT	1	P-05050	57,99 €
				3	400		1,3	HM - TCT	1	P-05066	49,99 €

## List pre chvostovú pílu, Liatinové rúry



Rozsah	Materiál	TPI	Celková dĺžka mm	Pracovná dĺžka mm	Hrúbka listu mm	Materiál listu	Ks / bal.	Obj. č.	MOC s DPH
★★★★☆	Kov, Liatina, Nerez	8	100	80	1.25	TC/HM	1	B-55566	11,99 €
			150	130	1.25	TC/HM	1	B-55572	15,99 €
			228	205	1.25	TC/HM	1	B-55588	21,99 €
			305	280	1.25	TC/HM	1	B-55594	26,99 €
★★★★☆	Liatina, Sklolaminát, Epoxidy	-	225	205	1	Diamond Grit	2	B-31871	45,99 €

## List pre chvostovú pílu, sada

Rozsah	Makita č.	Obsah sady	Ks / bal.	Obj. č.	MOC s DPH
★★★★★		P-04927; P-04911; P-04880; P-04999; P-05016	5	P-83945	15,99 €

## List pre chvostovú pílu, Nerez



Rozsah	Materiál	TPI	Celková dĺžka mm	Pracovná dĺžka mm	Hrúbka listu mm	Materiál listu	Ks / bal.	Obj. č.	MOC s DPH
★★★★☆	Nerez	18	152	128	1	TC/HM	2	B-07250	33,99 €

## List pre chvostovú pílu, Izolačné materiály



Rozsah	Materiál	Celková dĺžka mm	Pracovná dĺžka mm	Hrúbka listu mm	Materiál listu	Ks / bal.	Obj. č.	MOC s DPH
Špeciálny	Izolačné materiály	400	320	1.5	HCS	1	B-52130	31,99 €
Špeciálny	Izolačné materiály	225		1,17	HCS / CV	3	P-80438	28,99 €
Špeciálny	Izolačné materiály	300		1,27	HCS / CV	3	P-80444	39,99 €

## List pre chvostovú pílu, Sádrokartón štandardný rez



Rozsah	Materiál	Typ rezu	Typ zubu	TPI	Celková dĺžka mm	Pracovná dĺžka mm	Hrúbka listu mm	Materiál listu	Ks / bal.	Obj. č.	MOC s DPH
★★★★☆	Sádrokartón	Štandardný	Frézované bočne vsadenené zuby	6	100	80	0.9	Bi-Metal	5	B-20448	12,99 €

## List pre chvostovú pílu, Mrazené potraviny



Rozsah	Materiál	Typ rezu	Typ zubu	TPI	Celková dĺžka mm	Pracovná dĺžka mm	Hrúbka listu mm	Materiál listu	Ks / bal.	Obj. č.	MOC s DPH
Špeciálny	Ice	Štandardný	Frézované bočne vsadenené zuby	10	228	207	1.2	Nerez steel	1	B-30570	21,99 €
				10	305	279	1.2	Nerez steel	1	B-23254	23,99 €
		Hrubý		3	305	280	1.25	Nerez steel	1	B-10609	9,09 €
				6	152	131	1.2	Nerez steel	1	B-52043	21,99 €
				6	228	207	1.2	Nerez steel	1	B-30564	20,99 €
				6	305	279	1.2	Nerez steel	1	B-23248	22,99 €

## List pre chvostovú pílu, demolačný pílový list



Rozsah	Makita č.	Materiál	Typ rezu	Typ zubu	TPI	Celková dĺžka mm	Pracovná dĺžka mm	Hrúbka listu mm	Materiál listu	Ks / bal.	Obj. č.	MOC s DPH
★★★★★		Nerez, kov, hliník, drevo, drevo s klincami	Hrubý, rýchly	Špeciálne zuby v tvare M	5	150		0,9	Bi-Metal	5	P-45705	19,99 €
					5	200		0,9	Bi-Metal	5	P-45711	23,99 €
				Frézované bočné	10	225	205	1,57	Bi-Metal	3	P-46975	17,99 €
					6	225	205	1,57	Bi-Metal	3	P-47042	17,99 €

# DELENIE: PÍLOVÉ LISTY

## List pre chvostovú pílu, ľahké stavebné materiály



Rozsah	Materiál	TPI	Celková dĺžka mm	Pracovná dĺžka mm	Hrúbka listu mm	Materiál listu	Ks / bal.	Obj.č.	MOC s DPH
★★★★☆	Pórobeton, Mäkká tehla	2	305	267	1.5	TC/HM	1	B-10394	38,99 €
			455	420			1	B-10403	53,99 €
	Pórobeton, Mäkká tehla Epoxid	3	400	375			2	B-63591	54,99 €
			305	280			2	B-63585	41,99 €

## Pílové listy pre pásové píly s dĺžkou pásu 835 mm, vlnité zuby

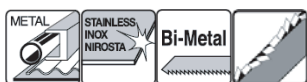

Dĺžka mm	Typ zuba	Materiál	Materiál listu	Tpi	Popis	Rozsah	Ks / bal.	Obj.č.	MOC s DPH
835	Vlnitý	PVC, nežeľzné kovy, mäkká oceľ liatina, tvrdá oceľ, nerez	BiM	14	Hrúbka materiálu: viac ako 5 mm	★★★	5	B-40543	45,99 €
				18	Hrúbka materiálu: 4 – 5 mm	★★★	5	B-40559	43,99 €
				24	Hrúbka materiálu: menej ako 4 mm	★★★	5	B-40565	47,99 €

## Pílové listy pre pásové píly s dĺžkou pásu 1140 mm, bočné zuby



Dĺžka mm	Typ zuba	Materiál	Materiál listu	Tpi	Popis	Rozsah	Ks / bal.	Obj.č.	MOC s DPH
1140	Bočné	PVC, nežeľzné kovy, mäkká oceľ	HCS	14	Hrúbka materiálu: viac ako 5 mm	★★★	3	792560-3	36,99 €
				18	Hrúbka materiálu: 4 – 5 mm	★★★	3	792559-8	32,99 €
				24	Hrúbka materiálu: menej ako 4 mm	★★★	3	792558-0	33,99 €
		PVC, nežeľzné kovy, mäkká oceľ liatina, tvrdá oceľ, nerez	BiM	10	Hrúbka materiálu: viac ako 5,5 mm	★★★	1	B-30128	22,99 €
				14	Hrúbka materiálu: viac ako 5 mm	★★★	1	792557-2	20,99 €
				18	Hrúbka materiálu: 4 – 5 mm	★★★	1	792556-4	21,99 €

## Pílové listy pre pásové píly s dĺžkou pásu 1140 mm, vlnité zuby

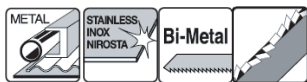

Dĺžka mm	Typ zuba	Materiál	Materiál listu	Tpi	Popis	Rozsah	Ks / bal.	Obj.č.	MOC s DPH
1140	Vlnitý	PVC, nežeľzné kovy, mäkká oceľ liatina, tvrdá oceľ, nerez	BiM	24	Hrúbka materiálu: menej ako 4 mm	★★★	1	194692-6	23,99 €

## Pílové listy pre pásové píly s dĺžkou pásu 1140 mm, bočné zuby



Dĺžka mm	Typ zuba	Materiál	Materiál listu	Tpi	Rozsah	Ks / bal.	Obj.č.	MOC s DPH
1140	Bočné	Drevo	HCS	6	★★★	3	792567-9	33,99 €

## Pílové listy pre pásové píly s dĺžkou pásu 2240 mm, bočné zuby



Dĺžka mm	Typ zuba	Materiál	Materiál listu	Tpi	Popis	Rozsah	Ks / bal.	Obj.č.	MOC s DPH
2240	Bočné	Nežeľzné kovy	HCS	14	Hrúbka materiálu: viac ako 5 mm	★★★	3	B-16695	64,99 €

## Pílové listy pre pásové píly s dĺžkou pásu 2240 mm, bočné zuby



Dĺžka mm	Typ zuba	Materiál	Materiál listu	Tpi	Rozsah	Ks / bal.	Obj.č.	MOC s DPH
2240	Bočné	Drevo, priečny rez	HCS	4	★★★	3	B-16667	55,99 €
		Drevo, oblúkový rez	HCS	6	★★★	3	B-16689	47,99 €
		Drevo, univerzálny rez	HCS	4	★★★	3	B-16673	47,99 €

## DELENIE: PRÍSLUŠENSTVO PRE PRIAMOČIARE PÍLY

	model	Obj. č.	MOC s DPH
--	-------	---------	-----------

### Odsávací adaptér



DJV180, 4350T/CT/FCT, 4351T/CT/FCT	417853-4	0,79 €
DJV181, DJV182	126331-0	2,59 €
JV001G / JV002G	122C71-6	cena na vyžiadanie

### Plastová klzná doska



DJV180, DJV181, DJV182, JV100D, JV183D 4350CT/FCT, 4351CT/FCT	417852-6	1,47 €
JV001G / JV002G	413J99-0	cena na vyžiadanie

### Chránič proti vytrhávaniu materiálu



DJV180, DJV181, DJV182, JV100D, JV101D, JV102D, JV103D, 4326, 4327/M, 4328, 4329, 4350T/CT/FT/FCT, 4351T/CT/FCT, JV0600, JV001G / JV002G	415524-7	0,29 €
--	----------	--------

### Adaptér k vodiacim lištám Makita



JV100D, JV101D, JV102D, JV103D, JV143D, JV183D 4326, 4327/M, 4328, 4329, JV0600, JV001G / JV002G DJV180, DJV181, DJV182, 4350T/CT/FCT, 4351T/CT/FCT	193517-1	25,99 €
---	----------	---------

### Doraz na vyrezávanie kruhov



JV100D, JV101D, JV102D, JV103D, JV143D, JV183D 4326, 4327/M, 4328, 4329, JV0600, JV001G / JV002G DJV180, DJV181, DJV182, 4350T/CT/FCT, 4351T/CT/FCT	192732-4	7,09 €
---	----------	--------

model	popis	Obj. č.	MOC s DPH
-------	-------	---------	-----------

### Príslušenstvo pre pásové píly



DPB181, DPB182,	kryt pílového pásu	197975-3	31,96 €
všetky modely	rezací vosk	191897-9	13,99 €
DPB183	rukoväť	158237-4	2,39 €

### Prepravné kufre

DJV180, DJV181, DJV182, JV100D,	PVC	141486-0	30,99 €
4350FC/FCT, 4351FC/FCT	PVC	824809-4	24,99 €



## DELENIE: PRÍSLUŠENSTVO PRE HOBLÍKY

model	Obj. č.	MOC s DPH
<b>Mierka na nastavenie nožov</b> *****		
DKP180, DKP181, KP0800, KP0810/C, N1900B, N1923B, 1002BA, 1100, 1902, 1911B, 1912B, KP001G	123062-2	11,99 €
2012NB	762016-0	4,29 €
<b>Nástrčný kľúč 9</b>		
DKP180, DKP181, KP312, KP0800, KP001G, KP0810/C, N1900B, N1923B, 1002BA, 1100, 1804N, 1805N, 1806B, 1902, 1911B, 1912B	782209-3	1,89 €
<b>Prítlačná doštička</b>		
DKP180, DKP181, KP0800, KP0810/C, N1900B, N1923B, 1100, 1902	A-86175	5,80 €
KP312/S	345328-2	40,31 €
<b>Držiak noža na brúsenie</b>		
DKP180, DKP181, KP0800, KP0810/C, N1900B, N1923B, 1100, 1902, KP001G	123004-6	4,39 €
1804N, 1805N, 1806B	123006-2	6,69 €
1002BA, 1911B 1912B	123055-9	3,69 €
<b>Paralelný doraz</b>		
KP0800, DKP180, N1923B, MT191, M1901, M1902	165581-2	6,19 €
DKP181, KP810/C, KP001G	191C23-8	30,99 €
1806B	123053-3	15,99 €
<b>Paralelný doraz pre bočné vedenie</b>		
KP0810, KP0810C, DKP181, KP001G	122791-4	32,99 €
<b>Skrutka zaistovania paralelného dorazu</b>		
DKP180, DKP181, KP0800, KP810/C	265785-7	0,40 €
<b>Odsávacie adaptéry</b>		
DKP180, DKP181, KP0800, KP810/C, KP001G	416368-8	1,31 €
<b>Adaptér na odsávaciu hadicu ø 45 mm</b>		
1806, KP312S	181575-9	6,89 €
DKP180, KP0800, KP0810/C	451329-1	1,40 €
<b>Vak na prach</b>		
1902	STEX122269	43,99 €
DKP180, KP0800, KP0810/C, DKP181, KP001G	122793-0	24,99 €
DKP181	191C21-2	27,99 €
<b>Plastový kufrík</b>		
KP0800	824892-1	16,99 €
KP0810/C	824786-0	54,99 €
<b>Príslušenstvo ku 2012NB</b>		
držiak s magnetom	762014-4	4,09 €
nastaviteľná doska pre nôž	343692-5	11,69 €
skrutka noža M4 x 6	922103-9	0,31 €
odsávací nástavec	193036-7	23,99 €
(bez možnosti pripojenia k vysávačom Makita)		

model	dĺžka (mm)	materiál	ks/bal	Obj. č.	MOC s DPH
<b>Nože</b> *****					
N1923B/H, KP0810/C, KP001G	82	HSS	set 2 ks	D-16346	7,09 €
KP0800, DKP180/181	82	TC	set 2 ks	D-07967	17,99 €
1911B	110	TC	set 2 ks	D-08822	27,99 €
1806	170	HSS	set 2 ks	D-63666	25,99 €
2012NB	306	HSS	set 2 ks	199911-5	104,99 €

<b>Nože obojstranné</b> *****					
N1923B/H, KP0810/C	82	TC	set 2 ks	D-07945	11,99 €
KP0800, DKP180/181	82	TC	set 5ks	D-35302	52,99 €
KP312/S	312	HSS	set 2 ks	B-02870	41,99 €
2012NB	306	HSS	set 2 ks	793346-8	40,99 €

### Brúsny kameň

veľkosť (mm)	zrntosť	obj. č.	MOC s DPH
150	WA1200	794061-7	12,99 €
180	WA1200	794060-9	15,99 €



popis	šírka (mm)	Obj. č.	MOC s DPH
<b>Dlabačka 7104L</b> *****			
dlabacia retaz	21	A-16592	524,99 €
vodiaca lišta	15 - 24	133571-3	274,00 €



## TCT drážkovacia fréza



D (mm)	L (mm)	OL (mm) stopka (mm)	Obj. č.	MOC s DPH
--------	--------	---------------------------	---------	-----------

3	10	42	8	P-78689	33,99 €
4	10	42	8	P-78695	33,99 €
5	16	51	8	P-78704	33,99 €
6	16	51	8	P-78710	35,99 €
6	23	58	8	P-78726	37,99 €
8	20	52	8	P-78732	37,99 €
10	20	52	8	P-78760	42,99 €
12	20	52	8	P-78776	42,99 €
12	25	67	12	P-78748	52,99 €
12	50	92	12	P-78754	71,99 €

14	20	52	8	P-78782	44,99 €
15	20	52	8	P-78798	45,99 €
16	20	52	8	P-78807	45,99 €
18	20	52	8	P-78813	47,99 €
20	20	52	8	P-78829	49,99 €
24	20	52	8	P-78835	50,99 €
25	20	52	8	P-78841	50,99 €

Prírodné a ručne opracované drevo a plasty.  
Táto séria líčovacích fréz sa môže používať na profilovanie, líčovanie, drážkovanie, vyrezávanie otvorov, rýh a zahlbovanie do širokej palety rôznych materiálov.  
Táto paleta líčovacích fréz kombinuje kvalitu, spoľahlivosť a výkonnosť. Sú vyrobené z karbidu volfrámu, ktorý zabezpečuje dlhšiu životnosť fréz.

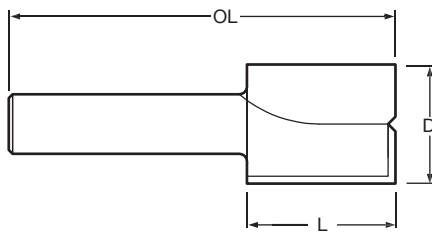
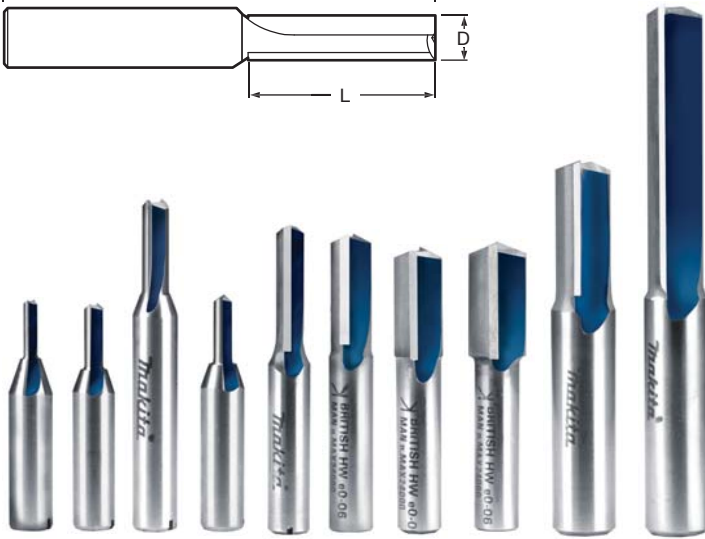
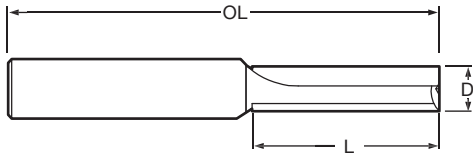

## FRÉZOVANIE

### TCT žliabkovacia fréza s ložiskom

Prírodne a ručne opracované drevo a plasty. Dva tvary produkované jednou frérou pomocou výmeny ložiska. Ložisko B16 odstraňuje drážky. Väčšie ložiská sú menej náchylné na vznik tepla a majú dlhšiu životnosť ako malé ložiská.

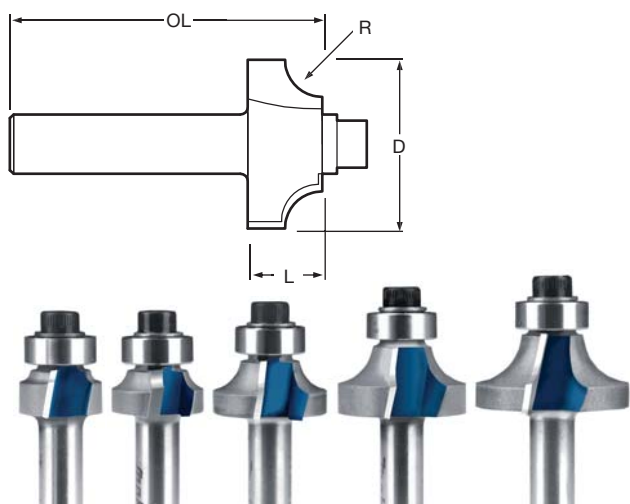

D (mm)	R (mm)	L (mm)	OL (mm)	stopka (mm)	Obj. č.	MOC s DPH
--------	--------	--------	---------	-------------	---------	-----------



16,7	2	8	40	8	P-78857	40,99 €
18,7	3	8	40	8	P-78863	43,99 €
22	5	10	42	8	P-78879	45,99 €
25	6,3	12,7	45	8	P-78885	43,99 €
28,35	8	13	45	8	P-78891	49,99 €
31,7	9,5	15,8	48	8	P-78900	54,99 €

Tvary dosiahnuté pomocou zaobľovacích fréz.

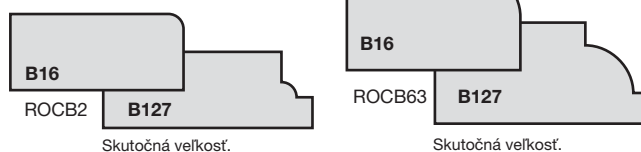

D (mm)	d (mm)	R (mm)	L (mm)	OL (mm)	stopka (mm)	Obj. č.	MOC s DPH
--------	--------	--------	--------	---------	-------------	---------	-----------

### TCT zaobľovacia fréza s ložiskom

Prírodne a ručne opracované drevo a plasty. Táto séria obrysových fréz sa môže používať na profilovanie a vyhladzovanie profilov. Vďaka karbidovým hrotom je možné tieto frézy používať na širokú paletu rôznych materiálov. Táto séria je vyrábaná s menšími priermi.

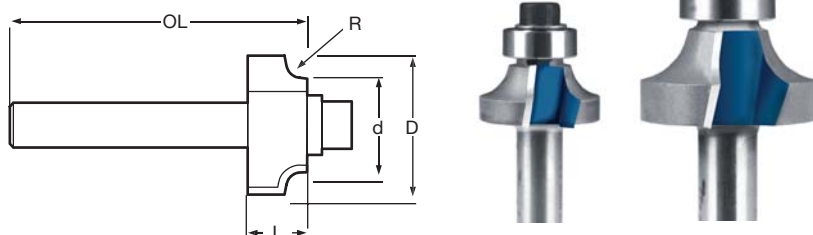

18,7	12,7	2	8	40	6	P-78916	49,99 €
20	12,7	3	9	41	6	P-78922	50,99 €

D (mm)	K (mm)	stopka (mm)	Obj. č.	MOC s DPH
--------	--------	-------------	---------	-----------

### TCT škárovacia fréza (Biskvit)

Prírodne a ručne opracované drevo a plasty. Umožňuje frézovanie biskvitových spojovacích štrbín do drevotriesky, MDF a tvrdých drev pomocou ručnej frézy.

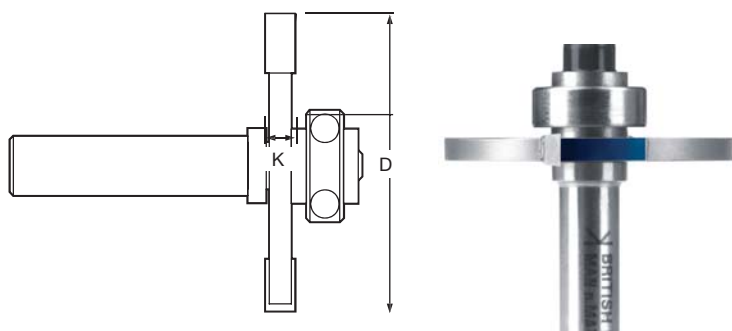

40	4	8	P-79120	57,99 €
----	---	---	---------	---------



## TCT žliabkovacia fréza

Prírodne a ručne opracované drevo a plasty.  
Kompletná séria fréz s možnosťou zahĺbenia s horným rezom. Väčšina fréz je kompatibilná so sériou používanou pri linkových spojoch.

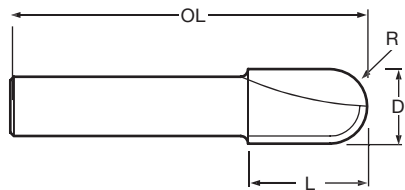

D (mm)	R (mm)	L (mm)	OL (mm)	stopka (mm)	Obj. č.	MOC s DPH
10	5	16	48	8	P-78950	35,99 €
12,7	6,3	17	49	8	P-78966	38,99 €
16	8	18	50	8	P-78972	39,99 €

## TCT profilová fréza (vnútorný úkos)

Prírodne a ručne opracované drevo a plasty.  
Umožňuje vytváranie pravouhlých rámov. Po zostavení a pri čapovaní sa nevyžaduje lícovanie.

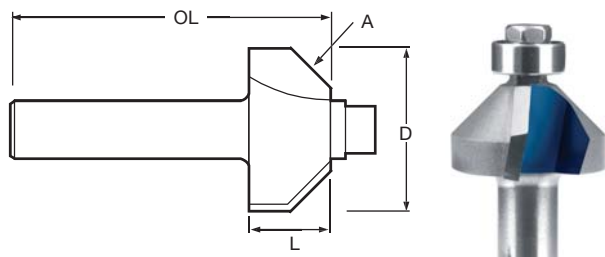

D (mm)	A°	L (mm)	OL (mm)	stopka (mm)	Obj. č.	MOC s DPH
22	45	11	43	8	P-79083	40,99 €

## TCT falcovacia fréza (Fréza na poldrážku)

Prírodne a ručne opracované drevo a plasty.

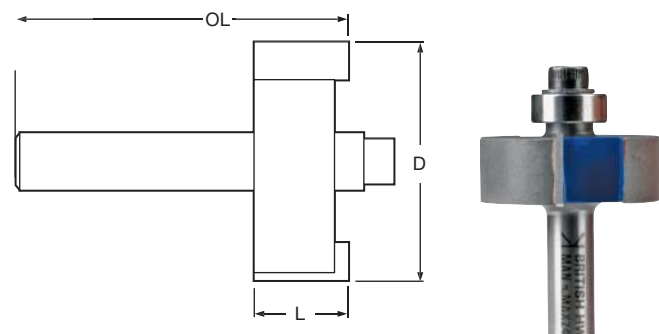

D (mm)	L (mm)	OL (mm)	stopka (mm)	Obj. č.	MOC s DPH
32	12,7	44	8	P-79136	47,99 €

## TCT fazetová fréza s ložiskom (fréza na vyduté panely)

Prírodne a ručne opracované drevo a plasty.  
Panelové frézy na profilovanie alebo drážkovanie  
dekoratívnych šablón a panelov.  
Vynikajúce pre čelá zásuviek.

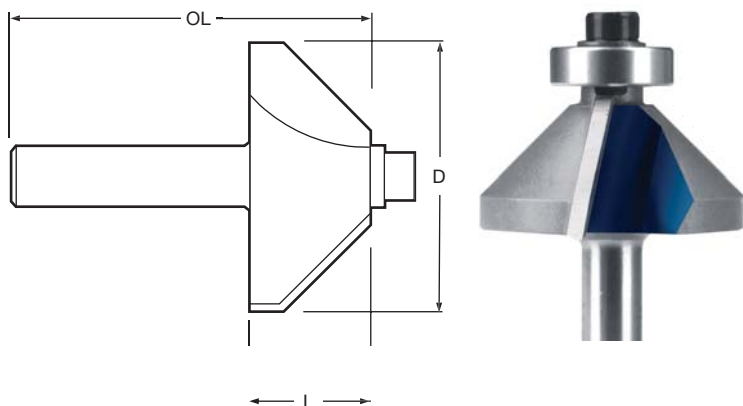

D (mm)	L (mm)	OL (mm)	stopka (mm)	Obj. č.	MOC s DPH
36	16	49	8	P-79099	40,99 €

## TCT zarovnávacía fréza (fréza na vodiace hrany)

Prírodne a ručne opracované drevo a plasty.  
Fréza s dlhšou životnosťou. Mimoriadne populárne  
frézy na frézovanie umakartu a laminátu.

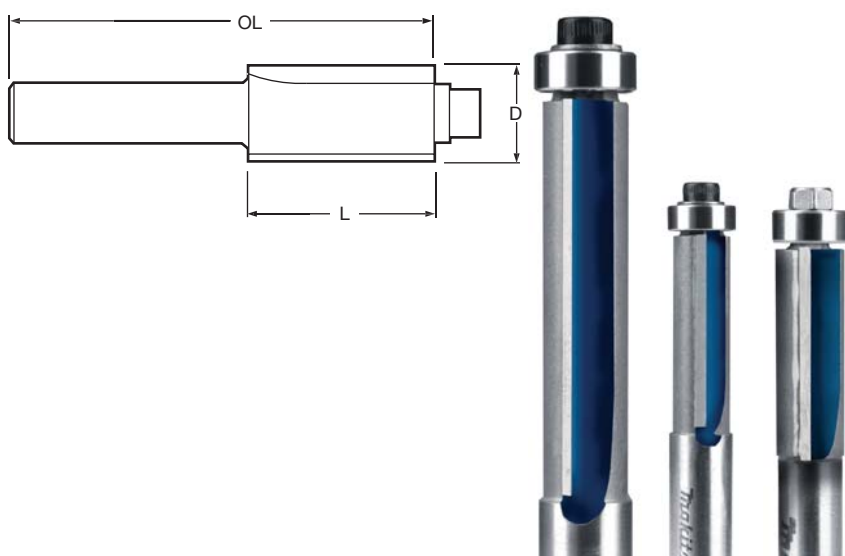

D (mm)	L (mm)	OL (mm)	stopka (mm)	Obj. č.	MOC s DPH
12,71	38,1	86	12	P-78994	47,99 €
12,7	25,4	57	8	P-79005	81,99 €
9,5	25	57	8	P-79011	40,99 €

## TCT zarovnávacía fréza (Fréza na vodiace hrany, malé priemery)

Prírodne a ručne opracované drevo a plasty.  
Vhodné na vyrezávanie otvorov a dier v karavanoch  
a v priemysle mobilných domov.

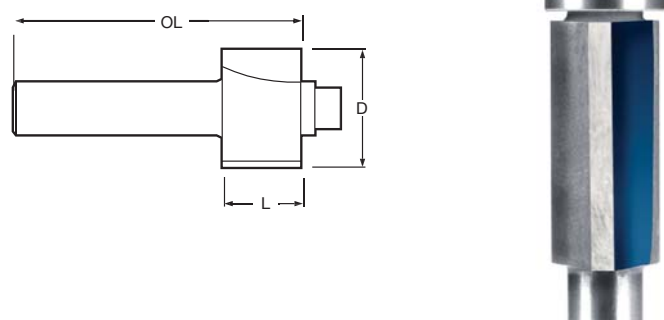

D (mm)	L (mm)	OL (mm)	stopka (mm)	Obj. č.	MOC s DPH
18	50	98	12	P-79027	69,99 €
18	12	50	8	P-78988	44,99 €

## TCT žliabkovacia fréza s ložiskom

### TCT žliabkovacia fréza

Prírodne a ručne opracované drevo a plasty. Táto séria obrysových fréz sa môže používať na profilovanie a úpravu hladkých povrchov na profile. Tieto frézy sa môžu vďaka karbidovým špičkám používať na rôzne druhy materiálov. Táto séria sa vyrába s menším priemerom.

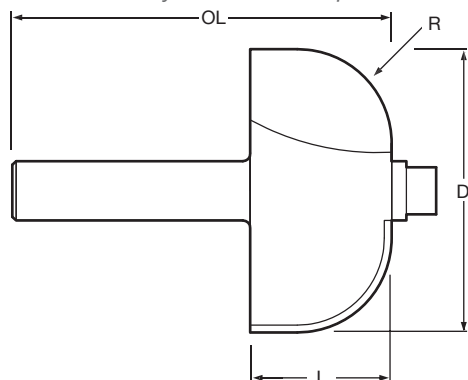

D (mm)	R (mm)	L (mm)	OL (mm)	stopka (mm)	Obj. č.	MOC s DPH
38,2	12,7	19	51	8	P-78938	59,99 €



38,2	12,7	19	51	8	P-78938	59,99 €
------	------	----	----	---	---------	---------

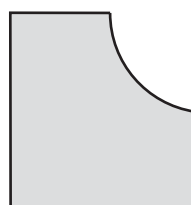

Dodávané s ložiskami B 127 a B 16.

**Tvar dosiahnutý pomocou frézy.**

CMC127 – Aktuálna veľkosť

### Frézovacie vrtáky

Priemer (mm)	Celková dĺžka (mm)	Pracovná dĺžka (mm)	Obj. č.	MOC s DPH
3,18	64	33	191G69-8	2,59 €
6,35	85	40	193447-6	18,99 €

### Ložiská pre frézy

objednávacie číslo frézy	typ ložiska	objednávacie číslo frézy	typ ložiska	objednávacie číslo frézy	typ ložiska	objednávacie číslo frézy	typ ložiska
P-78857	B127/B95	P-78916	B127	P-79011	B95/3.175	P-79083	B95/3.175
P-78863	B127/B95	P-78922	B127	P-79027	B18	P-79099	B127
P-78879	B127/B95	P-78938	B127	P-79033	B16/8	P-79120	B15
P-78885	B127/B95	P-78988	B18	P-79049	B16/8	P-79136	B127
P-78891	B127/B95	P-78994	B127	P-79055	B19/127		
P-78900	B127/B95	P-79005	B127	P-79077	B16		

### Ložiská pre frézy

typ ložiska	popis	objednávacie číslo	cena s DPH
B127	D=12,7 d=6,35 H=4,8	P-79245	6,29 €

D – vonkajší priemer  
d – vnútorný priemer  
H – výška

# FRÉZOVANIE

## TCT profilová vodiaca fréza s ložiskom



Prírodne a ručne opracovávané drevo a plasty.  
Séria PGC fréz je vyrábaná s centrálnymi hrotmi a je ideálna na slepé profilovanie a zahľbovanie napríklad pri dvojvrstvovej lepenke. Tieto frézy majú vodiace ložiská určené na elimináciu hornej montážnej šablóny.

D (mm)	L (mm)	OL (mm)	stopka (mm)	Obj. č.	MOC s DPH
19	50	96	12	P-79055	81,99 €
16	25	72	8	P-79049	54,99 €
16	20	67	8	P-79033	59,99 €

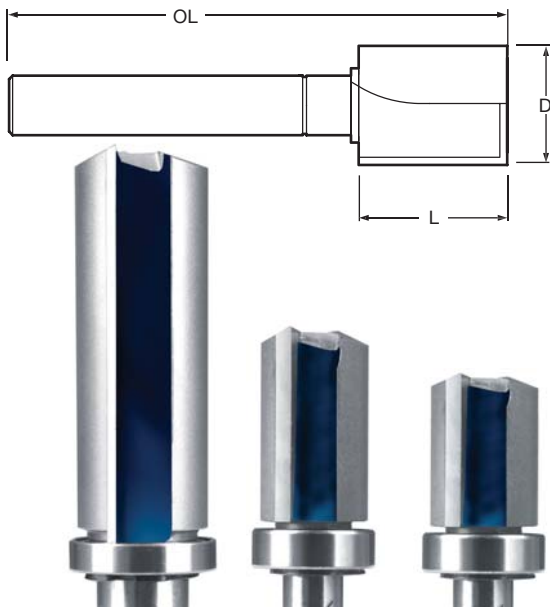

V porovnaní so sekačkou má séria s vodiacim profilom tú výhodu, že je schopná prechádzať cez vrstvu, ktorá má byť osekaná.

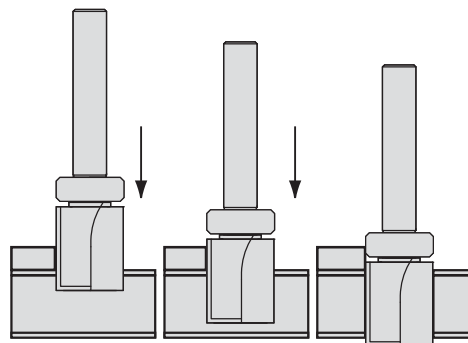

D (mm)	A°	L (mm)	OL (mm)	stopka (mm)	Obj. č.	MOC s DPH
--------	----	--------	---------	-------------	---------	-----------

## TCT rybinová fréza



Prírodne a ručne opracovávané drevo a plasty.  
Štandardná veľkosť pre všetky aplikácie, napríklad frézovanie na rybinu, skrytú rybinu atď. K dispozícii s rysovacími ihlami (na vyžiadanie), čo umožňuje ich používanie spoločne s prenosnými vodiacimi prípravkami.

12	10	10	42	8	P-79108	32,99 €
20	10	16	48	8	P-79114	49,99 €

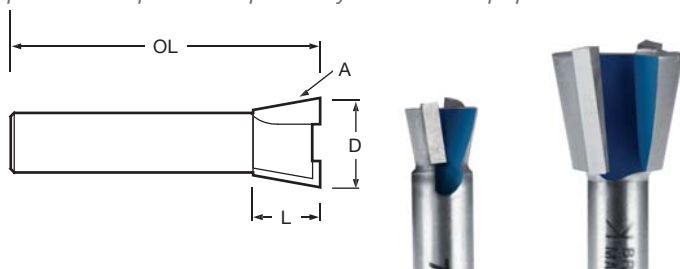

D (mm)	L (mm)	OL (mm)	stopka (mm)	Obj. č.	MOC s DPH
--------	--------	---------	-------------	---------	-----------



## TCT fazetová fréza s ložiskom (na hrany)



Prírodne a ručne opracovávané drevo a plasty.  
Táto fréza je najefektívnejšia na tvorbu sklonu a orezávanie plastov a laminátu.

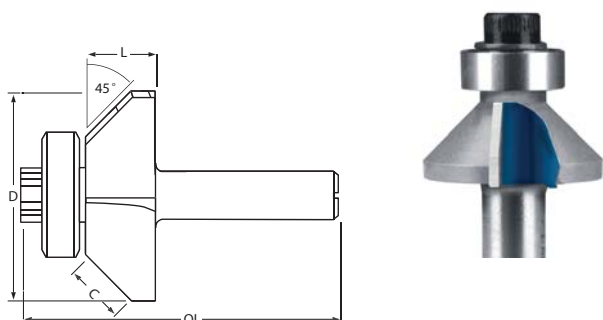

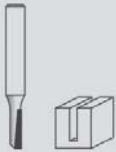

24	9	41	8	P-79077	40,99 €
----	---	----	---	---------	---------



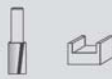
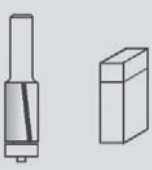

	priemer (mm)	dĺžka (mm)	celková dĺžka (mm)	rádius (mm)	hlbka rezu (mm)	uhol (°g)	stopka (mm)	veľkosť ložiska (mm)	max. otáčky (rpm)	Obj. č.	MOC s DPH
<b>TCT profilová vodiaca fréza</b>											
	3	13	51	-	-	-	8	-	28000	D-47379	8,29 €
	4	13	51	-	-	-	8	-	28000	D-47385	8,39 €
	5	13	48	-	-	-	8	-	28000	D-47391	7,49 €
	6	19	50,8	-	-	-	8	-	28000	D-47400	7,69 €
	6	19	50,8	-	-	-	6	-	28000	D-47416	7,79 €
	6	16	48	-	-	-	6	-	28000	D-47422	7,99 €
	6	25	57	-	-	-	6	-	24000	D-47438	8,39 €
	8	19	51	-	-	-	6	-	28000	D-47444	9,09 €
	8	25,4	57,4	-	-	-	6	-	24000	D-47450	8,49 €
	10	25,4	57,4	-	-	-	6	-	24000	D-47466	8,79 €
	12	32	64	-	-	-	6	-	24000	D-47472	10,09 €
	14	19	51	-	-	-	6	-	24000	D-47488	9,59 €
	20	19	51	-	-	-	6	-	24000	D-47494	13,99 €
	6	16	48	-	-	-	8	-	28000	D-47503	7,49 €
	6	19	51	-	-	-	8	-	28000	D-47519	7,89 €
	8	19	51	-	-	-	8	-	28000	D-47525	8,49 €
	10	19	51	-	-	-	8	-	28000	D-47531	8,89 €
	12	19	51	-	-	-	8	-	28000	D-47547	8,49 €
	14	19	51	-	-	-	8	-	24000	D-47553	10,39 €



# FRÉZOVANIE



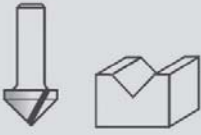

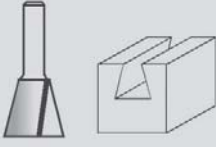
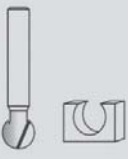
	priemer (mm)	dĺžka (mm)	celková dĺžka (mm)	rádius (mm)	hlbka rezu (mm)	uhol (dg)	stopka (mm)	veľkosť ložiska (mm)	max. otáčky (rpm)	Obj. č.	MOC s DPH
<b>TCT profilová vodiaca fréza</b>											
	16	19	51	-	-	-	8	-	24000	D-47569	11,99 €
	18	19	51	-	-	-	8	-	24000	D-47575	12,99 €
	20	19	51	-	-	-	8	-	24000	D-47581	13,99 €
	22	25,4	57,2	-	-	-	8	-	24000	D-47597	14,99 €
	24	25,4	57	-	-	-	8	-	24000	D-47606	17,99 €
	8	25	70	-	-	-	12	-	24000	D-47612	10,09 €
	10	25,4	70	-	-	-	12	-	24000	D-47628	10,29 €
	12	32	73	-	-	-	12	-	24000	D-47634	11,99 €
	16	32	73	-	-	-	12	-	24000	D-47656	14,99 €
	19	32	73	-	-	-	12	-	24000	D-47662	17,99 €
	22	32	73	-	-	-	12	-	24000	D-47678	18,99 €
	25	32	73	-	-	-	12	-	18000	D-47684	17,99 €
	9,5	26	66,9	-	-	-	6	9,5	24000	D-47690	9,99 €
	12,7	13	56	-	-	-	6	12,7	28000	D-47709	9,49 €
	12,7	26	68,5	-	-	-	6	12,7	24000	D-47715	10,99 €
	9,5	26	67	-	-	-	8	9,5	24000	D-47721	9,39 €
	12,7	13	55,7	-	-	-	8	12,7	28000	D-47737	10,29 €
	12,7	26	68,5	-	-	-	8	12,7	24000	D-47743	10,09 €
	12,7	26	68,5	-	-	-	8	12,7	24000	D-47759	15,99 €
	12,7	38	91,4	-	-	-	12	12,7	24000	D-47765	17,99 €
	6,35	19	65	-	-	-	8	-	28000	D-47787	8,29 €
	9,5	26	75	-	-	-	12	-	24000	D-47793	10,99 €
	6,35	12,7	44,5	3,2	-	-	6	-	28000	D-47802	7,89 €
	9,5	12,7	44,5	4,8	-	-	6	-	28000	D-47818	8,39 €
	12,7	19	51	6,35	-	-	6	-	28000	D-47824	12,99 €
	6,35	12,7	44,5	3,2	-	-	8	-	28000	D-47830	7,79 €
	9,5	12,7	44,5	4,8	-	-	8	-	28000	D-47846	8,59 €

# FRÉZOVANIE



	priemer (mm)	dĺžka (mm)	celková dĺžka (mm)	rádius (mm)	hlbka rezu (mm)	uhol (dg)	stopka (mm)	veľkosť ložiska (mm)	max. otáčky (rpm)	Obj. č.	MOC s DPH
<b>TCT profilová vodiaca fréza</b>											
	12,7	16	48	-	-	60dg	6	-	28000	D-47874	9,79 €
	19	16	47,6	-	-	90dg	6	-	24000	D-47880	11,99 €
	12,7	12,7	44,7	-	-	90dg	8	-	28000	D-47896	9,29 €
	15,9	12,7	44	-	-	90dg	8	-	24000	D-47905	9,99 €
	12,7	12,7	54	-	-	90dg	12	-	28000	D-47911	9,79 €
	19	16	47,6	-	-	90dg	8	-	24000	D-47933	10,99 €
	19	16	57,3	-	-	90dg	12	-	24000	D-47949	16,99 €
	6,35	6,35	38,3	3,2	-	-	8	-	28000	D-47977	7,69 €
	7,9	8	40	4	-	-	8	-	28000	D-47983	8,29 €
	12,7	10	41,5	6,35	-	-	8	-	28000	D-48000	9,19 €
	15,8	12,7	44,5	7,9	-	-	8	-	24000	D-48016	10,99 €
	15,8	12,7	54	7,9	-	-	12	-	24000	D-48022	12,99 €
	19	12,7	50,8	9,5	-	-	12	-	24000	D-48038	13,99 €
	25,4	16	57	12,7	-	-	12	-	18000	D-48044	20,99 €
	6,35	8	63,5	-	-	7.5 dg	8	-	28000	D-48050	8,39 €
	12,7	13	45	-	-	14 dg	8	-	28000	D-48072	9,19 €
	15	14,3	52	-	-	15 dg	8	-	24000	D-48088	9,79 €
	19	22,2	63,4	-	-	7 dg	12	-	24000	D-48094	13,99 €
	25,4	22,2	64	-	-	14 dg	12	-	18000	D-48103	16,99 €
	19	18,2	50,8	9,5	-	-	8	-	24000	D-48147	13,99 €

Akumulátory  
 Odkladacie systémy  
 Vŕtanie  
 Skrutkovanie  
 Brúsky  
 Pilenie  
 Frézovanie  
 Brúsenie  
 Klince / spony  
 Špeciálne stroje  
 Vysávanie  
 Fény/lampy  
 Záhrada  
 Ručné náradie  
 Ostatné

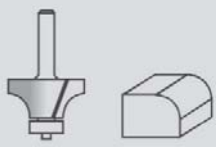



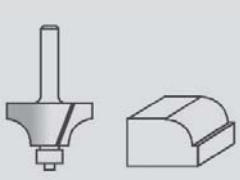

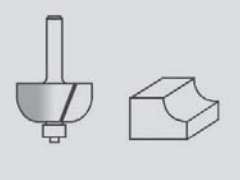
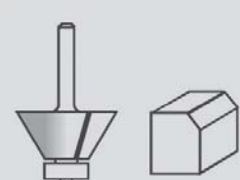
# FRÉZOVANIE

	priemer (mm)	dĺžka (mm)	celková dĺžka (mm)	rádus (mm)	hlbka rezu (mm)	uhol (dg)	stopka (mm)	veľkosť ložiska (mm)	max. otáčky (rpm)	Obj. č.	MOC s DPH
<b>TCT profilová vodiaca fréza s ložiskom</b>											
	19	12,7	44,7	6,35	-	-	8	-	24000	D-48153	12,99 €
	25,4	16	47,6	9,5	-	-	8	-	18000	D-48169	16,99 €
	38,1	28,6	60,3	12,7	-	-	8	-	16000	D-48175	22,99 €
	19	11	42,4	3,2	-	-	8	-	24000	D-48181	14,99 €
	31,3	16	47,9	6,35	-	-	8	-	18000	D-48197	20,99 €
	12,7	10	42	2,4	-	-	8	-	28000	D-48206	9,99 €
	19	12,7	44,7	4	-	-	8	-	24000	D-48212	14,99 €
	25,4	16	54	5,6	-	-	12	-	18000	D-48228	15,99 €
	19	9,5	42,5	3,2	-	-	6	-	24000	D-48278	9,99 €
	25,4	13,5	45,5	6,35	-	-	6	-	18000	D-48284	14,99 €
	19	9,5	53,4	3,2	-	-	6	12,7	24000	D-48290	12,99 €
	20,6	10	58,6	4	-	-	6	12,7	24000	D-48309	13,99 €
	25,4	13,5	56,5	6,35	-	-	6	12,7	18000	D-48315	15,99 €
	28,6	14,5	57,3	7,9	-	-	6	12,7	18000	D-48321	18,99 €
	31,8	16,7	59,7	9,5	-	-	6	12,7	18000	D-48337	20,99 €
	17,3	8	51	2,3	-	-	8	12,7	24000	D-48343	11,99 €
	19	9,5	53,4	3,2	-	-	8	12,7	24000	D-48359	11,99 €
	20,7	10	52,3	4	-	-	8	12,7	24000	D-48365	14,99 €
	22,2	12,7	55	4,8	-	-	8	12,7	24000	D-48371	14,99 €
	25,4	13,5	56,5	6,35	-	-	8	12,7	18000	D-48387	15,99 €
	28,6	14,5	57,3	7,9	-	-	8	12,7	18000	D-48393	18,99 €
	31,8	16,7	59,7	9,5	-	-	8	12,7	18000	D-48402	21,99 €
	38,1	19	62	12,7	-	-	8	12,7	16000	D-48418	25,99 €
50,8	25,4	76,2	19	-	-	12	12,7	14000	D-48424	41,99 €	

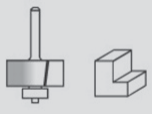
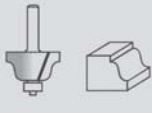

	priemer (mm)	dĺžka (mm)	celková dĺžka (mm)	rádius (mm)	hlbka rezu (mm)	uhol (dg)	stopka (mm)	veľkosť ložiska (mm)	max. otáčky (rpm)	Obj. č.	MOC s DPH
<b>TCT profilová vodiaca fréza s ložiskom</b>											
	17	8	49,1	2,3	-	-	6	9,5	24000	D-48430	12,99 €
	19	9,5	51,6	3,2	-	-	6	9,5	24000	D-48446	12,99 €
	20,3	10	50,5	4	-	-	6	9,5	24000	D-48452	14,99 €
	22,2	12,7	53,2	4,8	-	-	6	9,5	24000	D-48468	15,99 €
	28,6	14,5	55,5	7,9	-	-	6	9,5	18000	D-48474	18,99 €
	17,3	8	49,1	2,3	-	-	8	9,5	24000	D-48480	11,99 €
	19	9,5	51,6	3,2	-	-	8	9,5	24000	D-48496	11,99 €
	20,7	10	50,5	4	-	-	8	9,5	24000	D-48505	12,99 €
	22,2	13	53,2	4,8	-	-	8	9,5	24000	D-48511	12,99 €
	25,4	13,5	54,7	6,35	-	-	8	9,5	18000	D-48527	15,99 €
	31,8	17	57,9	9,5	-	-	8	9,5	18000	D-48549	20,99 €
	38,1	19	60,2	12,7	-	-	8	9,5	16000	D-48555	22,99 €
	28,6	12,7	50,8	4	-	-	8	12,7	18000	D-48577	17,99 €
	15,9	6,35	49,2	1,6	-	-	8	12,7	24000	D-48583	15,99 €
	17,5	6,35	49	2,4	-	-	8	12,7	24000	D-48599	15,99 €
	19	9,7	45,6	3,2	-	-	8	12,7	24000	D-48608	11,99 €
	22,2	12,7	55,6	4,8	-	-	8	12,7	24000	D-48614	13,99 €
	28,6	12,7	55,5	7,9	-	-	8	12,7	18000	D-48620	16,99 €
	31,8	14	56	9,5	-	-	8	12,7	18000	D-48636	17,99 €
	38,1	15,4	58,3	12,7	-	-	8	12,7	16000	D-48642	26,99 €
	25,4	11	51	-	-	45dg	6	12,7	18000	D-48658	14,99 €
	22,2	12,7	56,1	-	-	25dg	6	12,7	24000	D-48664	13,99 €
	31,8	13,5	55,1	-	-	45dg	8	12,7	18000	D-48686	20,99 €
	34,9	16	58,8	-	-	45dg	8	12,7	16000	D-48692	23,99 €
	41,3	20	58,9	-	-	45dg	8	12,7	16000	D-48701	27,99 €
	44,5	22,6	68,6	-	-	45dg	12	12,7	16000	D-48717	28,99 €
	50,8	27	70,9	-	-	45dg	12	12,7	14000	D-48723	39,99 €

# FRÉZOVANIE

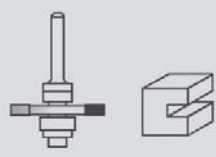
	priemer (mm)	dĺžka (mm)	celková dĺžka (mm)	rádus (mm)	hlbka rezu (mm)	uhol (dg)	stopka (mm)	veľkosť ložiska (mm)	max. otáčky (rpm)	Obj. č.	MOC s DPH
	31,8	12,2	54,6	-	9,5	-	8	12,7	18000	D-48739	20,99 €
	31,8	12,2	60,8	-	9,5	-	12	12,7	18000	D-48745	17,99 €
	25,4	9,5	52,5	3,2	-	-	6	12,7	18000	D-48804	18,99 €
	28,6	13	55,3	4	-	-	6	12,7	18000	D-48810	15,99 €
	28,6	13	55,3	4	-	-	8	12,7	18000	D-48751	16,99 €
	38,1	17,5	60	6,35	-	-	8	12,7	16000	D-48767	21,99 €
	31,8	12,7	55,6	4,8	-	-	8	12,7	18000	D-48773	23,99 €
	38,1	16	58,9	6,35	-	-	8	12,7	16000	D-48789	28,99 €
	25,4	12,7	53,7	4,8	-	-	6	12,7	18000	D-48795	17,99 €
	19	26	67,1	-	4,7	-	8	9,5	24000	D-48832	29,99 €
	28,6	41	90,2	-	7,9	-	12	12,7	18000	D-48848	40,99 €
	41	23,4	78,5	-	-	-	12	22	16000	D-48898	56,99 €
	41	23,4	78,5	-	-	-	12	22	16000	D-48898	56,99 €
	30,1	25,4	57,2	-	6,35	-	8	-	18000	D-48913	32,99 €
	41,3	25,4	76,2	-	7,9	-	12	-	16000	D-48929	39,99 €
	41	19	71	-	8,5	-	12	24	16000	D-48935	39,99 €
	47,6	2	59	-	12,7	-	8	22,2	16000	D-48941	18,99 €
	47,6	2,5	59	-	12,7	-	8	22,2	16000	D-48957	20,99 €
	47,6	3	59	-	12,7	-	8	22,2	16000	D-48963	20,99 €
	47,6	4	59	-	12,7	-	8	22,2	16000	D-48979	19,99 €
	47,6	5	59	-	12,7	-	8	22,2	16000	D-48985	19,99 €
	47,6	5,5	59	-	12,7	-	8	22,2	16000	D-48991	19,99 €

popis	D	A1	A2	A3	A4	L1	L2	L3	L4	R	R1	R2	H	3612, 3612C RP1800FX RP2300FCX	3620, RP0900 RP0910, RP1110C	3707, 3708, 3709, 3710	Obj. č.	MOC s DPH
-------	---	----	----	----	----	----	----	----	----	---	----	----	---	--------------------------------------	------------------------------------	---------------------------	---------	-----------

## Frézy s britmi osadenými tvrdokovom

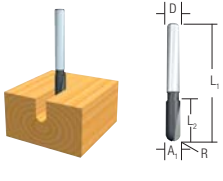
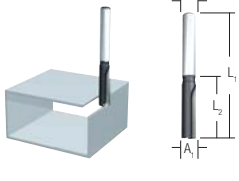
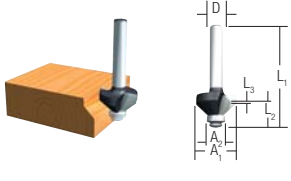
	fréza na zaoblené hrany	6	20	8		45	10	4	4					•	•	•	D-09357	21,99 €
	drážkovacia fréza	6	6			50	18							•	•	•	191Y83-2	14,99 €
	frézy na hliník	6	10			50	20							•	•	•	D-16988	14,99 €
	pérová fréza	12	38			61	4	20						•			D-12027	53,99 €
	fréza na oblité hrany	6	15	8		37	7	3,5	3					•	•	•	D-09422	29,99 €
		6	26	12	8	42	12	4,5	8					•	•	•	D-09547	30,99 €

# PRÍSLUŠENSTVO FRÉZY

## Klieštiny



model	klúč	upínanie	Obj. č.	MOC s DPH
3706, 3708	17 mm	1/8"	324149-5	12,99 €
		6 mm	763607-0	2,59 €
		1/4"	763608-8	2,79 €
DCO180, DCO181	17 mm	6 mm	763678-7	7,29 €
		1/8"	763677-9	11,99 €
		1/4"	763676-1	13,99 €
3709, 3710, 3711, 3712, M3700, M3702, MT372	10 mm 17 mm	6 mm	763662-2	5,59 €
		1/4"	763663-0	4,49 €
		matica	763661-4	0,99 €
DRT50, RT0700C, RT0702C, M3601, MT361, RT001G	13 mm 22 mm	6 mm	763636-3	7,69 €
		8 mm	763618-5	1,59 €
		1/4"	763637-1	7,49 €
3612, 3612C, 3612BR	13 mm 24 mm	matica	763615-1	1,39 €
		12 mm	763628-2	18,99 €
		1/2"	763622-4	11,99 €
RP0900	13 mm 22 mm	matica	763629-0	4,59 €
		6 mm	763636-3	7,69 €
		8 mm	763618-5	1,59 €
RP0910, RP1110C	13 mm 22 mm	1/4"	763637-1	7,49 €
		matica	763615-1	1,39 €
		6 mm	*193180-0	23,99 €
RP1800, RP2300, RP1803, RP2303, 3612, 3612C, M3600, M3602, MT362	17 mm	8 mm	*193178-7	20,99 €
		matica	763652-5	cena na vyžiadanie
		12 mm	763628-2	18,99 €
RP1800, RP1803, RP2300, RP2303, 3612, 3612C	24 mm	1/2"	763622-4	11,99 €
		matica	763674-5	6,29 €
		6 mm	763801-4	5,29 €
RP1800, RP1803, RP2300, RP2303, 3612, 3612C	12 mm	8 mm	763804-8	4,69 €
		10 mm	763807-2	5,79 €
		1/4"	763808-0	6,69 €

\* sada

## Vodiace objímky

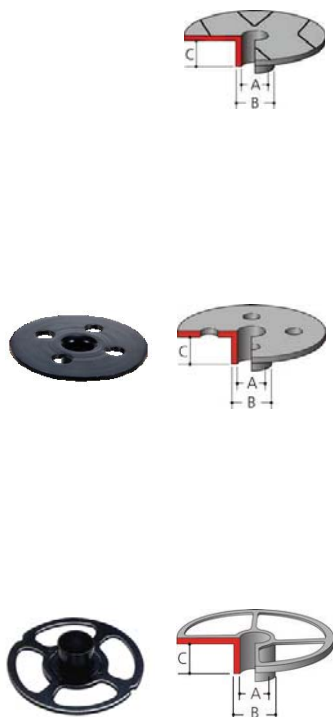

model	A (mm)	B (mm)	C (mm)	Obj. č.	MOC s DPH
DRT50, 3707/F/FC, 3708/F/FC, 3709, 3710, 3711, 3712, N3701, RT0700C, RT0702C	8	10	9,5	343577-5	0,59 €
DRT50**, 3612BR, RP0900, RP1800/F, RP1801/F, RP1803C, RP2300FC, RP2301FC, RP2303C, RT0700C**, RT0702C**	7,7	09.V	11.V	164379-4	16,99 €
	9	11	13	164775-6	15,99 €
	10	12	9	164388-3	17,99 €
	11	12.VII	13	164776-4	17,99 €
	14.V	16	13	344364-5	2,29 €
	18	20	13	164393-0	24,99 €
	24	27	13	164470-8	24,99 €
	27	30	13	164471-6	11,99 €
RP0910, RP1110C	37	40	13	165046-4	23,99 €
	14,5	16	11,5	193334-9	13,99 €
	27	30	13	193338-1	14,99 €
	37	40	13	193339-9	17,99 €

\*\*Použite s montážou ponornej základne

# PRÍSLUŠENSTVO FRÉZY

## Príslušenstvo pre frézy RT0700, DRT50, RT0702C, RT001G



vodiaca základňa

196613-4

29,99 €



platňa základne

454842-8

3,38 €



vodiaca základňa  
priehľadná

199089-4

27,99 €



základňa na ponor

195563-0

90,99 €



základňa uhlová  
-30° až 45°

198987-9

39,99 €



predsadená základňa

195562-2

115,99 €



taška pre RT0700, RT0702C, DRT50, 3706, RT001G  
rozmery (ŠxVxD) 304 x 406 x 304 mm

831327-5

46,99 €



Akumulátory

Odkládacie  
systémy

Vŕtanie

Skrutkovanie

Brúsky

Pílenie

Frézovanie

Brúsenie

Klince / spony

Špeciálne stroje

Vysávanie

Fény/lampy

Záhrada

Ručné náradie

Ostatné

# FRÉZOVANIE

model	popis	typ	Obj. č.	MOC s DPH
-------	-------	-----	---------	-----------

## Príslušenstvo pre frézy



3709, 3710, 3711, 3712	vodiaca základňa		194267-1	14,99 €
3709, 3710, 3711, 3712	sklopná základňa		194269-7	65,95 €
3709, 3710, 3708, 3711, 3712, RT001G, RT0700, RT0702C	vedenie frézy		122703-7	4,59 €
3612BR, RP1800, RP2300, RP1803C, RP2303C	vedenie frézy		123022-4	16,99 €

## Paralelne dorazy



DRT50, RT0700		A	122965-7	4,39 €
3709, 3710		A	122704-5	4,39 €
3612BR, RP1800, RP2300		A	342428-9	5,49 €
3620, RP0900/0910, RP1110C, M3601, MT361		A	164834-6	5,99 €
DRT50*, RP0900, RP0910, RP1110C, RP1800, RP1803C, RP2300, RP2303C, RT0700C*, RT0702C, RT001G, 3711, 3712		B	195136-9	68,99 €
RT001G**, DRT50**, RT0702C**, 3612BR, RP0900, RP0910, RP1110C, RP1800C, RP1803C, RP2300C, RP2303C	adaptér k vodiacej lište		194579-2	41,99 €

\* s použitím ponornej základne 195563-0; \*\* s použitím základne 195563-0

## Držiak paralelného dorazu



3612			122256-6	30,99 €
DRT50, RT001G, RT0700, RT0702C	použitie s ponornou základňou 195563-0		195564-8	5,19 €

## Odsávacie adaptéry



RT0700, RT0702C, DRT50, RT001G		A	195559-1	3,09 €
RP0900, RT0700**, RT001G, RT0702C, DRT50**		B	194733-8	3,09 €
3612, M3600, MT362		C	415412-8	4,39 €
RP1800, RP2300, RP1803C, RP2303C		C	194934-8	10,49 €
3706, DCO180, DCO181		D	193449-2	6,59 €

\*\*\* použitie s ponornou základňou 195563-0

## Príslušenstvo pre štrbinové frézy DPJ180, PJ7000, 3901



ø mm	vŕtanie	popis	počet zubov	hrúbka kotúča (mm)	Obj. č.	MOC s DPH
100	22	štrbinová fréza	6	4	B-20644	22,99 €
40		príruba vnútorná			224280-6	4,89 €
40		matica príruby			224505-8	3,78 €
		doraz PJ700, DPJ180			123149-0	21,99 €
		kľúč kolikový			782401-1	1,29 €
		vak na prach 3901			122474-6	4,59 €
		vak na prach PJ700, DPJ180			123150-5	6,79 €
		adaptér 25 – 27 mm			192349-3	7,19 €
		adaptér odsávania (koleno)			415252-4	1,64 €
		lodička spojovacia N°20 56 x 23,5 mm			P-08850	36,99 €



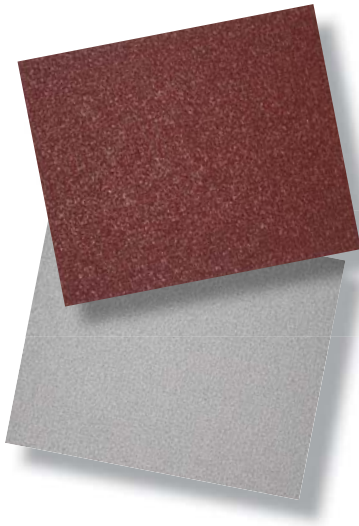

## PRÍSLUŠENSTVO NA BRÚSENIE

### Brúsne papiere

V našej ponuke nájdete dva typy brúsnych papierov:

**Červené** – brúsne papiere s dlhou životnosťou vhodné na brúsenie dreva, farebných kovov, plastov, kovu alebo kameňa. Tieto papiere sú štandardne dodávané perforované alebo neperforované v širokej škále zrnitosti, veľkosti a balení.

**Biele** – brúsne papiere s dlhou životnosťou vhodné na brúsenie dreva, farebných kovov, plastov, kovu alebo kameňa. Tieto brúsne papiere sú ideálne na konečnú úpravu materiálov – brúsenie farieb a lakov. Brúsne papiere sú štandardne dodávané perforované alebo neperforované v širokej škále zrnitosti, veľkosti a balení.

### Použitie brúsnych papierov

farba	drevo	drevené materiály	kov	kameň	plasty	konečná povrchová úprava (farba/lak)
červená	••	••	••	••	••	•
biela	•	•	•	•	•	••

•• Ideálne použitie / • Možné použitie

### Každý obal brúsnych papierov Makita obsahuje nasledujúce informácie

The diagram shows a Makita sandpaper package with the following labels and icons:



- Počet kusov v balení** (Number of pieces in the package) - icon of a sandpaper sheet.
- Objednávacie číslo** (Ordering number) - icon of a document.
- Rozmer brúsneho papiera** (Sandpaper size) - icon of a sandpaper sheet.
- Značky, pri ktorých je možné tiež použiť papier** (Brands for which the paper can also be used) - icons for MAKITA, BOSCH, B&D/DEWALT, and METABO.
- Rozloženie dier na odsávanie prachu** (Dust suction hole layout) - icon of a sandpaper sheet with a dust suction hole.
- Uchytenie (v tomto prípade na suchý zips)** (Attachment (in this case on dry zip)) - icon of a dry zip fastener.
- Typ stroja (v tomto prípade excentrická brúska)** (Machine type (in this case eccentric sander)) - icons for various sanding machines.
- Odporúčaný materiál (v tomto prípade drevo, kov a dokončovacie práce)** (Recommended material (in this case wood, metal and finishing work)) - icons for wood, metal, and finishing work.
- Zrnitosť** (Grain size) - icon of a sandpaper sheet with a grain size indicator.

On the right side, there is a list of icons representing various applications of the sandpaper:



- Vibračné brúsky (Vibrating sanders)
- Excentrické brúsky (Eccentric sanders)
- Pásovité brúsky (Belt sanders)
- Vibračné brúsky (Vibrating sanders)
- Multi Tool
- Elektrické pilníky (Electric files)
- Kov (Metal)
- Farby, lak (Paint, varnish)
- Odstraňovanie hrdz (Rust removal)
- Suchý zips (Dry zip)
- Dokončovacie práce (Finishing work)



# VIBRAČNÉ BRÚSKY – MALÉ VIBRAČNÉ BRÚSKY

Popis	zrnitosť	ks/bal	BO4555	BO4556	BO4557	BO4565	DBO480	Obj. č.	MOC s DPH
<b>Brúsny papier 114 × 140 mm, neperforovaný</b> 									
<p>Vhodné pre farebné kovy, plasty, drevo, drevo s klincami, kov, kameň</p> 	40	10	•	•	•		•	P-36398	3,29 €
	60	10	•	•	•		•	P-32904	2,49 €
	80	10	•	•	•		•	P-36407	2,89 €
	100	10	•	•	•		•	P-32910	2,69 €
	120	10	•	•	•		•	P-32926	2,49 €
	150	10	•	•	•		•	P-32932	2,59 €
	180	10	•	•	•		•	P-36413	2,29 €
	240	10	•	•	•		•	P-36429	2,39 €

Popis	zrnitosť	ks/bal	BO4555	BO4556	BO4557	BO4565	DBO480	Obj. č.	MOC s DPH
<b>Brúsny papier 114 × 140 mm, neperforovaný</b> 									
<p>Vhodné pre laky a farby, farebné kovy, plasty, drevo, drevo s klincami, kov, kameň.</p> 	60	10	•	•	•		•	P-36522	3,79 €
	100	10	•	•	•		•	P-36544	3,29 €
	120	10	•	•	•		•	P-36550	3,09 €

Popis	zrnitosť	ks/bal	BO4555	BO4556	BO4557	BO4565	DBO480	Obj. č.	MOC s DPH
<b>Brúsny papier na suchý zips 114 × 102 mm, perforovaný, 6 otvorov</b> 									
<p>Vhodné pre farebné kovy, plasty, drevo, drevo s klincami, kov, kameň.</p> 	40	10	•				•	P-33087	3,99 €
	60	10	•				•	P-33093	3,89 €
	80	10	•				•	P-33102	3,89 €
	100	10	•				•	P-33118	3,69 €
	120	10	•				•	P-33124	3,69 €
	150	10	•				•	P-33130	3,39 €
	180	10	•				•	P-33146	3,69 €
	240	10	•				•	P-33152	3,89 €
	320	10	•				•	P-33168	3,49 €
	40	50	•				•	P-42416	17,99 €
	60	50	•				•	P-42422	14,99 €
	80	50	•				•	P-42438	15,99 €
	120	50	•				•	P-42450	15,99 €

## VIBRAČNÉ BRÚSKY – MALÉ VIBRAČNÉ BRÚSKY

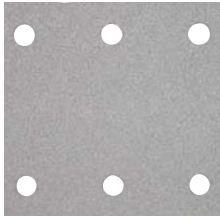
popis	zrnitosť	ks/bal	BO4555	BO4556	BO4557	BO4565	DBO480	Obj. č.	MOC s DPH		
<b>Brúsny papier na suchý zips 114 × 102mm, perforovaný 6 otvorov</b> <span style="float: right;">*****</span>											
Vhodné pre laky a farby, farebné kovy, plasty, drevo, drevo s klincami, kov, kameň.		brúsny papier	40	10	•			•	•	P-35807	4,59 €
			60	10	•			•	•	P-35813	4,59 €
			80	10	•			•	•	P-35829	4,29 €
			100	10	•			•	•	P-35835	4,19 €
			120	10	•			•	•	P-35841	4,19 €
			150	10	•			•	•	P-35857	3,99 €
			320	10	•			•	•	P-35885	4,09 €
			40	50	•			•	•	P-42503	19,99 €
			60	50	•			•	•	P-42519	18,99 €
			150	50	•			•	•	P-42553	18,99 €

popis	zrnitosť	ks/bal	BO4555	BO4556	BO4557	BO4565	DBO480	Obj. č.	MOC s DPH		
<b>Brúsny papier na suchý zips 95 × 95 × 95 mm, perforovaný 6 otvorov</b> <span style="float: right;">*****</span>											
Vhodné pre farebné kovy, plasty, drevo, drevo s klincami, kov, kameň.		brúsny papier	40	10				•	•	P-33255	3,19 €
			60	10				•	•	P-33261	3,19 €
			80	10				•	•	P-33277	3,09 €
			100	10				•	•	P-33283	2,99 €
			120	10				•	•	P-33299	2,99 €
			150	10				•	•	P-33308	2,99 €
			180	10				•	•	P-33314	2,99 €
			240	10				•	•	P-33320	2,99 €
			320	10				•	•	P-33336	2,99 €
			40	50				•	•	P-42597	11,99 €
			60	50				•	•	P-42606	11,99 €
			80	50				•	•	P-42612	12,99 €
			100	50				•	•	P-42628	11,99 €
			120	50				•	•	P-42634	12,99 €
			150	50				•	•	P-42640	10,79 €
			180	50				•	•	P-42656	10,79 €
			240	50				•	•	P-42662	11,49 €

popis	zrnitosť	ks/bal	BO4555	BO4556	BO4557	BO4565	DBO480	Obj. č.	MOC s DPH		
<b>Brúsny papier na suchý zips 95 × 95 × 95 mm, perforovaný 6 otvorov</b> <span style="float: right;">*****</span>											
Vhodné pre laky a farby, farebné kovy, plasty, drevo, drevo s klincami, kov, kameň.		brúsny papier	40	10				•	•	P-42684	3,39 €
			60	10				•	•	P-42690	3,19 €
			80	10				•	•	P-42709	3,09 €
			100	10				•	•	P-42715	2,89 €
			120	10				•	•	P-42721	2,99 €
			150	10				•	•	P-42737	2,89 €
			240	10				•	•	P-42759	2,69 €
			320	10				•	•	P-42765	2,89 €
			60	50				•	•	P-42787	10,99 €
			80	50				•	•	P-42793	10,89 €
			100	50				•	•	P-42802	11,99 €
			120	50				•	•	P-42818	12,99 €

# VIBRAČNÉ BRÚSKY – MALÉ VIBRAČNÉ BRÚSKY

popis	zrmitosť	ks/bal	DBO380 /DBO381	BO3700, BO3710, BO3711	M9203	Obj. č.	MOC s DPH
-------	----------	--------	-------------------	------------------------------	-------	---------	-----------

## Brúsny papier 93 × 228 mm, neperforovaný



Vhodné pre farebné kovy, plasty, drevo, drevo s klincami, kov, kameň.

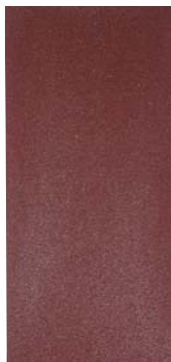

brúsny papier	40	10	•	•		P-36136	2,69 €
	60	10	•	•		P-32948	2,49 €
	80	10	•	•		P-36142	2,39 €
	100	10	•	•		P-32954	2,29 €
	120	10	•	•		P-36158	2,29 €
	240	10	•	•		P-36170	2,09 €

## Brúsny papier 93 × 228 mm, perforovaný



Vhodné pre farebné kovy, plasty, drevo, drevo s klincami, kov, kameň.



brúsny papier	40	10	•	•	•	P-31837	3,09 €
	60	10	•	•	•	P-31843	2,89 €
	80	10	•	•	•	P-31859	2,79 €
	100	10	•	•	•	P-31865	2,79 €
	120	10	•	•	•	P-36011	2,79 €
	150	10	•	•	•	P-36027	2,79 €
	180	10	•	•	•	P-36033	2,79 €
	240	10	•	•	•	P-36049	2,79 €
	40	50	•	•	•	P-36055	11,99 €
	60	50	•	•	•	P-36061	10,49 €
	80	50	•	•	•	P-36077	10,69 €
	100	50	•	•	•	P-36083	9,89 €
	120	50	•	•	•	P-36099	10,39 €
	150	50	•	•	•	P-36108	10,19 €
	180	50	•	•	•	P-36114	9,49 €
	240	50	•	•	•	P-36120	9,99 €

## Brúsny papier na suchý zips 93 × 185 mm, perforovaný, suchý zips



Vhodné pre farebné kovy, plasty, drevo, drevo s klincami, kov, kameň.



brúsny papier	40	10	•	•	•	P-31871	4,79 €
	60	10	•	•	•	P-31887	4,29 €
	80	10	•	•	•	P-31893	4,19 €
	100	10	•	•	•	P-31902	4,09 €
	120	10	•	•	•	P-35891	4,09 €
	150	10	•	•	•	P-35900	3,99 €
	180	10	•	•	•	P-35916	3,99 €
	240	10	•	•	•	P-35922	3,79 €
	40	50	•	•	•	P-35938	19,99 €
	60	50	•	•	•	P-35944	18,99 €
	80	50	•	•	•	P-35950	16,99 €
	100	50	•	•	•	P-35966	16,99 €
	120	50	•	•	•	P-35972	16,99 €
	150	50	•	•	•	P-35988	15,99 €
	180	50	•	•	•	P-35994	16,99 €

## VIBRAČNÉ BRÚSKY – MALÉ VIBRAČNÉ BRÚSKY

popis	zrnfosť	ks/bal	BO4900V	9046	Obj. č.	MOC s DPH
-------	---------	--------	---------	------	---------	-----------

### Brúsny papier so suchým zipsom 115 × 229mm, perforovaný 10 otvorov



Vhodné pre farebné kovy, plasty, drevo, drevo s klincami, kov, kameň.



brúsny papier	zrnfosť	ks/bal	BO4900V	9046	Obj. č.	MOC s DPH
	40	10	•	•	P-33174	6,19 €
	60	10	•	•	P-33180	6,09 €
	80	10	•	•	P-33196	5,79 €
	100	10	•	•	P-33205	4,99 €
	120	10	•	•	P-33211	5,39 €
	180	10	•	•	P-33233	5,49 €
	240	10	•	•	P-33249	5,49 €
	80	50	•	•	P-35748	21,99 €

### Brúsny papier so suchým zipsom 115 × 229mm, perforovaný 14 otvorov



Vhodné pre farebné kovy, plasty, drevo, drevo s klincami, kov, kameň.

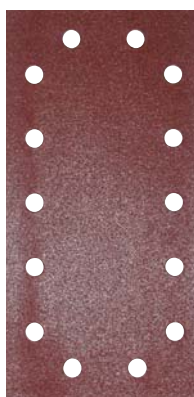

brúsny papier	zrnfosť	ks/bal	BO4900V	9046	Obj. č.	MOC s DPH
	40	10	•	•	P-43022	5,89 €
	60	10	•	•	P-43038	5,59 €
	80	10	•	•	P-43044	5,49 €
	100	10	•	•	P-43050	5,39 €
	120	10	•	•	P-43066	5,39 €
	80	50	•	•	P-43125	22,99 €
	240	50	•	•	P-43175	25,99 €

### Brúsny papier 115 × 280mm, perforovaný, 14 otvorov



Vhodné pre farebné kovy, plasty, drevo, drevo s klincami, kov, kameň.

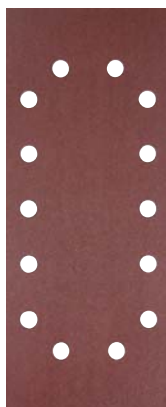

brúsny papier	zrnfosť	ks/bal	BO4900V	9046	Obj. č.	MOC s DPH
	40	10	•	•	P-33009	3,79 €
	60	10	•	•	P-33015	3,29 €
	80	10	•	•	P-33021	3,19 €
	100	10	•	•	P-33037	3,09 €
	120	10	•	•	P-33043	3,09 €
	150	10	•	•	P-33059	3,59 €
	180	10	•	•	P-33065	3,39 €
	150	50	•	•	P-35695	12,99 €

# EXCENTRICKÉ BRÚSKY

## Brúsny papier na suchý zips 125 mm, 8 otvorov



Vhodné pre farebné kovy, plasty, drevo, drevo s klincami, kov, kameň.

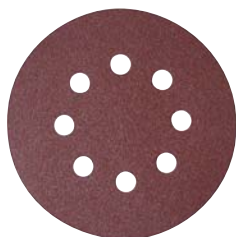

popis	zrnitosť	ks/bal	BO5010, BO5012, BO5030, BO5031	BO5020, BO5021, BO5041	DBO180	Obj. č.	MOC s DPH
brúsny papier	40	10	•	•	•	P-43533	4,59 €
	60	10	•	•	•	P-43549	4,39 €
	80	10	•	•	•	P-43555	4,09 €
	100	10	•	•	•	P-43561	4,09 €
	120	10	•	•	•	P-43577	4,09 €
	180	10	•	•	•	P-43583	4,09 €
	240	10	•	•	•	P-43599	4,09 €
	320	10	•	•	•	P-43608	4,09 €
	400	10	•	•	•	P-43614	4,09 €
	40	50	•	•	•	P-43620	20,99 €
	60	50	•	•	•	P-43636	19,99 €
	80	50	•	•	•	P-43642	17,99 €
	100	50	•	•	•	P-43658	17,99 €
	120	50	•	•	•	P-43664	17,99 €
	180	50	•	•	•	P-43670	17,99 €
	240	50	•	•	•	P-43686	17,99 €
	320	50	•	•	•	P-43692	17,99 €
	400	50	•	•	•	P-43701	17,99 €

## Brúsny papier na suchý zips 125 mm, 8 otvorov



Vhodné pre farebné kovy, plasty, drevo, drevo s klincami, kov, kameň.

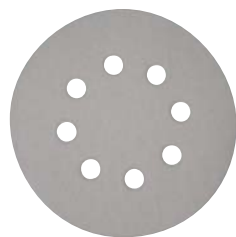

popis	zrnitosť	ks/bal	BO5010, BO5012, BO5030, BO5031	BO5020, BO5021, BO5041	DBO180	Obj. č.	MOC s DPH
brúsny papier	40	10	•	•	•	P-33342	4,09 €
	60	10	•	•	•	P-33358	3,99 €
	80	10	•	•	•	P-33364	3,69 €
	100	10	•	•	•	P-33370	3,59 €
	120	10	•	•	•	P-33386	3,59 €
	180	10	•	•	•	P-33392	3,59 €
	240	10	•	•	•	P-33401	3,59 €
	320	10	•	•	•	P-33417	3,59 €
	400	10	•	•	•	P-33423	3,59 €
	40	50	•	•	•	P-37384	17,99 €
	60	50	•	•	•	P-37390	17,99 €
	80	50	•	•	•	P-37409	15,99 €
	100	50	•	•	•	P-37415	14,99 €
	120	50	•	•	•	P-37421	15,99 €
	180	50	•	•	•	P-37437	14,99 €
	240	50	•	•	•	P-37443	14,99 €
	320	50	•	•	•	P-37459	15,99 €
	400	50	•	•	•	P-37465	14,99 €

### Sada brúsnych papierov Ø 125 mm

D-77229

9,19 € (MOC s DPH)

suchý zip, 8 dierové  
5 x # 60  
5 x # 120  
5 x # 240  
5 x # 320



# EXCENTRICKÉ BRÚSKY

popis	zrnitost	ks/bal	BO5010, BO5012, BO5030, BO5031	BO5020, BO5021, BO5041	BO6030	BO6040	Obj. č.	MOC s DPH
-------	----------	--------	---	------------------------------	--------	--------	---------	-----------

## Brúsny papier na suchý zips 150mm, 6 otvorov



Vhodné pre laky a farby, farebné kovy, plasty, drevo, drevo s klincami, kov, kameň.



brúsny papier	40	10			•	•	P-37471	6,39 €
	60	10			•	•	P-37487	6,29 €
	80	10			•	•	P-37493	5,99 €
	100	10			•	•	P-37502	5,59 €
	120	10			•	•	P-37518	5,59 €
	180	10			•	•	P-37524	5,59 €
	240	10			•	•	P-37530	5,59 €
	320	10			•	•	P-37546	5,59 €
	400	10			•	•	P-37552	5,69 €
	40	50			•	•	P-37568	30,99 €
60	50			•	•	P-37574	28,99 €	

## Brúsny papier na suchý zips 150mm, 6 otvorov



Vhodné pre laky a farby, farebné kovy, plasty, drevo, drevo s klincami, kov, kameň.



brúsny papier	80	50			•	•	P-37580	26,99 €
	100	50			•	•	P-37596	25,99 €
	120	50			•	•	P-37605	25,99 €
	180	50			•	•	P-37611	26,99 €
	240	50			•	•	P-37627	24,99 €
	320	50			•	•	P-37633	25,99 €
400	50			•	•	P-37649	19,99 €	

## Brúsny papier na suchý zips 150mm, 6 otvorov





Vhodné pre laky a farby, farebné kovy, plasty, drevo, drevo s klincami, kov, kameň.



brúsny papier	40	10			•	•	P-37655	5,79 €
	60	10			•	•	P-37661	5,29 €
	80	10			•	•	P-37677	5,19 €
	100	10			•	•	P-37683	4,99 €
	150	10			•	•	P-37699	5,29 €
	180	10			•	•	P-37708	4,79 €
	240	10			•	•	P-37714	4,79 €
	400	10			•	•	P-37736	4,79 €
	40	50			•	•	P-37742	23,99 €
	60	50			•	•	P-37758	24,99 €
	80	50			•	•	P-37764	21,99 €
	120	50			•	•	P-37786	21,99 €
	180	50			•	•	P-37792	23,99 €
	240	50			•	•	P-37801	21,99 €
	320	50			•	•	P-37817	21,99 €

# EXCENTRICKÉ BRÚSKY

Popis	Zrmitosť	ks/bal	BO5010, BO5012, BO5030, BO5031	BO5020, BO5021, BO5041	BO6030	BO6040	Obj. č.	MOC s DPH
<b>Brúsny papier na suchý zips 150mm, 8 + 1 otvor</b>								
<p>Vhodné pre farebné kovy, plasty, drevo, drevo s klincami, kov, kameň.</p> 	40	10			•	•	P-31918	6,39 €
	60	10			•	•	P-31924	6,29 €
	80	10			•	•	P-31930	6,09 €
	100	10			•	•	P-31946	5,59 €
	120	10			•	•	P-31952	5,59 €
	150	10			•	•	P-31968	6,09 €
	180	10			•	•	P-31974	5,59 €
	220	10			•	•	P-31980	5,09 €
	240	10			•	•	P-31996	5,59 €
	320	10			•	•	P-32007	5,39 €
	60	50			•	•	P-32580	27,99 €
	80	50			•	•	P-32596	27,99 €
	400	50			•	•	P-32677	25,99 €

Popis	Zrmitosť	ks/bal	BO5010, BO5012, BO5030, BO5031	BO5020, BO5021, BO5041	BO6030	BO6040	Obj. č.	MOC s DPH
<b>Brúsny papier na suchý zips 150mm, 8 + 1 otvor</b>								
<p>Vhodné pre laky a farby, farebné kovy, plasty, drevo, drevo s klincami, kov, kameň.</p> 	40	10			•	•	P-37839	5,49 €
	60	10			•	•	P-37845	5,39 €
	80	10			•	•	P-37851	5,49 €
	100	10			•	•	P-37867	4,79 €
	120	10			•	•	P-37873	4,79 €
	150	10			•	•	P-37889	5,09 €
	180	10			•	•	P-37895	4,99 €
	220	10			•	•	P-37904	4,79 €
	240	10			•	•	P-37910	4,79 €
	400	10			•	•	P-37932	5,29 €
	100	50			•	•	P-37976	21,99 €
	240	50			•	•	P-38009	20,99 €
	320	50			•	•	P-38015	20,99 €
400	50			•	•	P-38021	21,99 €	

Akumulátory  
 Odkladacie systémy  
 Vŕtanie  
 Skrutkovanie  
 Brúsky  
 Pilenie  
 Frézovanie  
 Brúsenie  
 Klince / spony  
 Špeciálne stroje  
 Vysávanie  
 Fény/lampy  
 Záhrada  
 Ručné náradie  
 Ostatné

# EXCENTRICKÉ BRÚSKY

## Brúsny papier / rolka



popis	rozmer / m	zrnitosť	Obj. č.	MOC s DPH
brúsny papier	120 / 5	40	P-38102	6,89 €
	120 / 5	60	P-38118	5,49 €
	120 / 5	80	P-38124	4,79 €
	120 / 50	80	P-38211	43,99 €
	120 / 5	100	P-38130	4,39 €
	120 / 5	120	P-38146	4,39 €
	120 / 5	180	P-38152	4,39 €
	120 / 5	240	P-38168	4,39 €
	120 / 5	320	P-38174	4,39 €
	120 / 5	400	P-38180	4,39 €





# ELEKTRICKÉ PILNÍKY

## Textilný brúsny pás 6 × 533 mm



Vhodné pre farebné kovy, plasty, drevo, drevo s klincami, kov, kameň.



popis	zrnitosť	ks/bal	9032	9037	9910	9911	Obj. č.	MOC s DPH
Brúsny papier	40	5	•				P-43181	4,39 €
	60	5	•				P-43197	4,89 €
	80	5	•				P-43206	4,49 €
	100	5	•				P-43212	4,89 €
	120	5	•				P-43228	4,39 €

## Textilný brúsny pás 9 × 533 mm



Vhodné pre farebné kovy, plasty, drevo, drevo s klincami, kov, kameň.



Brúsny papier	40	5	•				P-43256	5,59 €
	60	5	•				P-43262	5,39 €
	80	5	•				P-43278	5,29 €
	100	5	•				P-43284	5,19 €
	120	5	•				P-43290	5,19 €
	150	5	•				P-43309	5,19 €
	240	5	•				P-43315	5,19 €

## Textilný brúsny pás 13 × 533 mm



Vhodné pre farebné kovy, plasty, drevo, drevo s klincami, kov, kameň.



Brúsny papier	40	5	•				P-43321	6,99 €
	60	5	•				P-43337	6,89 €
	80	5	•				P-43343	6,59 €
	100	5	•				P-43359	6,49 €
	120	5	•				P-43365	7,19 €
	150	5	•				P-43371	6,19 €

## Textilný brúsny pás 30 × 533 mm



Vhodné pre farebné kovy, plasty, drevo, drevo s klincami, kov, kameň.



Brúsny papier	40	5		•			P-36675	4,39 €
	60	5		•			P-36681	4,29 €
	80	5		•			P-36697	4,19 €
	100	5		•			P-36706	3,99 €
	120	5		•			P-36712	3,99 €
	150	5		•			P-36728	4,19 €
	240	5		•			P-36734	3,79 €

## ELEKTRICKÉ PILNÍKY

popis	zrntosť	ks/bal	9032	9031	9910	9911	Obj. č.	MOC s DPH
-------	---------	--------	------	------	------	------	---------	-----------

### Textilný brúsny pás 30 × 533 mm



Vhodné na sklo –  
suché brúsenie.



Brúsny papier	60	5		•			P-01404	9,79 €
	80	5		•			P-01199	9,59 €
	100	5		•			P-01208	8,69 €
	120	5		•			P-01214	8,09 €
	150	5		•			P-01220	8,09 €
	240	5		•			P-01236	8,09 €

## PÁSOVÉ BRÚSKY

### Textilný brúsny pás 76 × 457 mm



Vhodné na sklo –  
suché brúsenie



Brúsny papier	40	5				•	•	P-37091	9,09 €
	60	5				•	•	P-37100	8,89 €
	80	5				•	•	P-37116	8,79 €
	100	5				•	•	P-37122	8,69 €
	120	5				•	•	P-37138	8,69 €
	150	5				•	•	P-37144	8,69 €
	240	5				•	•	P-37150	8,69 €
	40, 80, 120	3				•	•	P-37166	5,39 €

popis	zrntosť	ks/bal	9903	9920	9924DB	9402	9403	9404	Obj. č.	MOC s DPH
-------	---------	--------	------	------	--------	------	------	------	---------	-----------

### Textilný brúsny pás 76 × 533 mm



Vhodné pre farebné  
kovy, plasty, drevo,  
drevo s klincami,  
kov, kameň.



Brúsny papier	40	5	•						P-37172	9,89 €
	60	5	•						P-37188	9,39 €
	80	5	•						P-37194	8,79 €
	100	5	•						P-37203	8,59 €
	120	5	•						P-37219	8,59 €
	150	5	•						P-37225	8,59 €
	240	5	•						P-37231	8,59 €
	40	25	•						P-37247	42,99 €
	60	25	•						P-37253	40,99 €
	80	25	•						P-37269	36,99 €
	100	25	•						P-37275	35,99 €
	120	25	•						P-37281	35,99 €
	150	25	•						P-37297	35,99 €
	40	50	•						P-43393	78,99 €
	60	50	•						P-43402	75,99 €
	80	50	•						P-43418	72,99 €
	100	50	•						P-43424	71,99 €
	120	50	•						P-43430	74,99 €
	150	50	•						P-43446	74,99 €

# PÁSOVÉ BRÚSKY

## Textilný brúsny pás 76 × 610mm



Vhodné pre farebné kovy, plasty, drevo, drevo s klincami, kov, kameň.



popis	zrnfosť	ks/bal	9903	9920	9924DB	9402	9403	9404	Obj. č.	MOC s DPH
Brúsny papier	40	5			•	•			P-37312	11,19 €
	60	5			•	•			P-37328	10,09 €
	80	5			•	•			P-37334	9,39 €
	100	5			•	•			P-37340	8,39 €
	120	5			•	•			P-37356	8,59 €
	150	5			•	•			P-37362	8,99 €
	240	5			•	•			P-37378	9,19 €
	40	25			•	•			P-51144	45,99 €
	80	25			•	•			P-51164	41,99 €
	100	25			•	•			P-51172	42,99 €
	120	25			•	•			P-51188	36,99 €

## Textilný brúsny pás 100 × 610mm



Vhodné pre farebné kovy, plasty, drevo, drevo s klincami, kov, kameň.



popis	zrnfosť	ks/bal	9903	9920	9924DB	9402	9403	9404	Obj. č.	MOC s DPH
Brúsny papier	40	5			•	•	•	•	P-36887	12,99 €
	60	5			•	•	•	•	P-36893	11,99 €
	80	5			•	•	•	•	P-36902	11,99 €
	100	5			•	•	•	•	P-36918	11,19 €
	120	5			•	•	•	•	P-36924	11,19 €
	150	5			•	•	•	•	P-36930	11,19 €
	240	5			•	•	•	•	P-36946	11,09 €
	40	25			•	•	•	•	P-36952	51,99 €
	60	25			•	•	•	•	P-36968	49,99 €
	80	25			•	•	•	•	P-36974	48,99 €
	100	25			•	•	•	•	P-36980	47,99 €
	120	25			•	•	•	•	P-36996	47,99 €
	150	25			•	•	•	•	P-37007	47,99 €
	240	25			•	•	•	•	P-37013	47,99 €
	40	50			•	•	•	•	P-43468	103,99 €
	60	50			•	•	•	•	P-43474	98,99 €
	80	50			•	•	•	•	P-43480	96,99 €
	100	50			•	•	•	•	P-43496	95,99 €
	120	50			•	•	•	•	P-43505	95,99 €
	150	50			•	•	•	•	P-43511	89,99 €
240	50			•	•	•	•	P-43527	87,99 €	

## PÁSOVÉ BRÚSKY

popis	zrnitosť	ks/bal	9903	9920	9924DB	9402	9403	9404	Obj. č.	MOC s DPH
-------	----------	--------	------	------	--------	------	------	------	---------	-----------

### Textilný brúsny pás 100 x 620 mm



Vhodné pre farebné kovy, plasty, drevo, drevo s klincami, kov, kameň.



Brúsny papier	zrnitosť	ks/bal	9903	9920	9924DB	9402	9403	9404	Obj. č.	MOC s DPH
	60	5			•				P-37035	11,99 €
	80	5			•				P-37041	11,09 €
	120	5			•				P-37063	10,89 €
	150	5			•				P-37079	10,39 €
	240	5			•				P-37085	10,39 €

popis	ø (mm)	typ	Obj. č.	MOC s DPH
-------	--------	-----	---------	-----------

### Príslušenstvo pre DSL800, DSL801



brúsny tanier	220	HARD	199938-5	67,99 €
suchý zip	210	SOFT	199939-3	57,99 €
	210	MEDIUM	199940-8	66,99 €
náhradné kefky		1	140J85-5	49,36 €
		2	140J86-3	13,21 €
predĺženie sada			199937-7	233,99 €

ø (mm)	zrnitosť	popis	ks/bal	Obj. č.	MOC s DPH
--------	----------	-------	--------	---------	-----------

### Príslušenstvo pre DSL800, DSL801



225	40	brúsny papier	25	B-68389	35,99 €
225	80		25	B-68395	32,99 €
225	120		25	B-68404	28,99 €
225	180		25	B-68410	28,99 €
225	320		25	B-68426	27,99 €

# PRÍSLUŠENSTVO BRÚSKY

model	popis	ø (mm)	typ	Obj. č.	MOC s DPH	
<b>*****</b>						
	BO6050	suchý zip	150	SOFT	197314-7	51,99 €
	BO6050	suchý zip	130	HARD	197317-1	51,99 €
	DPO500, DPO600, PO6000C, PV001G	suchý zip	125		197922-4	64,99 €
	DBO180, BO5030/31, BO5040/41	suchý zip	123		197468-0	13,99 €
	BO6030 BO6040	suchý zip	150	SOFT	196684-1	30,99 €
		suchý zip	150	MEDIUM	196685-9	25,99 €
		suchý zip	150	HARD	196686-7	30,99 €
	9237C/CB PV7000 SA7000	gumený	170		P-05913	7,29 €
		suchý zip	165		743053-3	21,99 €
	9237C/CB PV7000 SA7000	suchý zip	120		P-21777	10,99 €

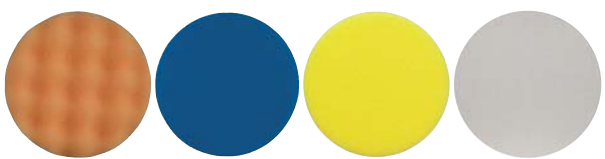

<b>*****</b>						
<b>Leštiace kotúče</b>						
	BO6030, BO6050, DPO500, DPO600	plstený kotúč na odstraňovanie vosku	150	suchý zip	193288-0	24,99 €
	BO5031, BO5041, DPO0500, DPO0600, DBO180	tanier na nanášanie vosku, žltý	125	suchý zip	794558-6	17,99 €



<b>*****</b>						
<b>Kotúče z jahňaciny na leštenie do vysokého lesku</b>						
	DPO500 / PO6000C		125	suchý zip	D-70867	8,89 €
	BO5031, BO5041, DBO180		140	suchý zip	794560-9	17,99 €
	BO6030, BO6050, DPO0500, DPO0600, PO6000C		150	suchý zip	199424-6	24,99 €
	PV001G, 9237CB		180	suchý zip	192629-7	27,99 €
	SA7000C		180		*794176-0	24,99 €

\*použitie s brúsnym tanierom P-05913

<b>*****</b>					
<b>Príslušenstvo pre brúsky DPV300 / PV301</b>					
	leštenie do vysokého lesku	80	plstený/ suchý zip	191N92-5	13,99 €
	penová špongia na nanášanie vosku	80	biela/ suchý zip	191N91-7	14,99 €
	penová špongia na leštenie	80	žltá/ suchý zip	191N90-9	10,99 €
	adaptér pre pad 743124-6			743126-2	3,39 €

## PRÍSLUŠENSTVO BRÚSKY



Priemer (mm)	Použitie	Zrnitosť	Ks/bal.	Obj. č.	MOC s DPH
<b>Brúsne kotúče pre DPV300 / PW301</b> <span style="float: right;">*****</span>					
					
50	kov	A60	25	E-07412	47,99 €
50	kov	A80	25	E-07428	47,99 €
50	kov	A120	25	E-07434	47,99 €
50	kov	Z60	25	E-07440	47,99 €
50	kov	Z80	25	E-07456	47,99 €

<b>Brúsne kotúče s rúnom pre DPV300 / PW301</b> <span style="float: right;">*****</span>					
					
50	Tvrдый: povrchové leštenie, odstraňovanie farby a hrdzi	hrubý	25	E-07462	86,99 €
50		stredný	25	E-07478	86,99 €
50		mäkký	25	E-07484	86,99 €
50	Jemný: povrchové leštenie	stredný	25	E-07490	75,99 €
50		mäkký	25	E-07509	75,99 €
50		veľmi jemný	25	E-07515	75,99 €

model	popis	ks/bal	Obj. č.	MOC s DPH
<b>Dierovacie dosky pre brúsky</b> <span style="float: right;">*****</span>				
				
BO4555, BO4556, BO4557, BO4558, DBO480, DBO481, DBO482	dierovacia doska	1	450066-4	0,89 €
BO3700, BO3710, BO3711, DBO380, DBO381	dierovacia doska	1	192989-7	6,39 €
9046, BO4900V	dierovacia doska	1	192523-3	27,99 €

<b>Základné dosky pre brúsky</b> <span style="float: right;">*****</span>					
					
DBO180, BO5030, BO5031, BO5040, BO5041, M9204, MT924	doska základná suchý zip	1	197468-0	13,99 €	
BO4555	doska základná suchý zip	1	158323-1	6,98 €	
BO4556, BO4557, BO4558	doska základná suchý zip	1	158324-9	4,89 €	
DBO480	doska základná, trojuholník, suchý zip	1	191Y22-2	9,29 €	
DBO480	doska základná, obdĺžnik, suchý zip	1	191Y23-0	8,59 €	
DBO480	doska základná, štvorec, suchý zip	1	191Y24-8	6,89 €	
BO3070, BO3710, BO3711, DBO380, DBO381,	doska základná suchý zip	1	194930-6	16,99 €	
BO4900V	doska základná suchý zip	1	193521-0	51,51 €	
9036	doska základná	1	122442-9	88,67 €	
DBO380, DBO381, BO3700, BO3710, BO3711, M9203	doska základná	1	140441-9	4,58 €	
9046	doska základná	1	162172-0	35,24 €	
DBO480	doska základná štvorec	1	191Y25-6	5,59 €	

# PRÍSLUŠENSTVO BRÚSKY

model	popis	ks/bal	Obj. č.	MOC s DPH	
<b>Papierové sáčky a držiaky</b> <span style="float: right;">*****</span>					
	BO3711, BO4558, BO4565, BO5031, BO5041, DBO180, DBO380, DBO381,	PVC box s papierovým vrecom	1	135246-0	3,68 €
	BO3711, BO4558, BO4565, BO5031, BO5041, DBO180, DBO380, DBO381,	papierové vrečko pre PVC box 135246-0	5	194746-9	6,39 €
	BO3711, BO4558, BO4565, BO5031, BO5041, DBO180, DBO380, DBO381,	vak na prach látkový	1	135222-4	5,59 €
	9046, BO3700, BO371, BO3711, BO4900, BO6030	držiak na papierové vrečko	1	193294-5	11,99 €
	9046, BO3700, BO371, BO3711, BO4900, BO6030	papierové vrečko pre držiak 193294-5	5	193293-7	7,19 €
	BO4900, BO4900V, BO6030	vak na prach látkový	1	151517-7	11,99 €
	BO3711, BO4558, BO4565, BO5031, BO5041, DBO180, DBO380, DBO381,	polyesterové vrečko pre PVC box	1	168557-8	2,99 €

<b>Elektrické pilníky</b> <span style="float: right;">*****</span>					
	9032, DBS180	oporné rameno 9 x 533 mm		125158-5	34,99 €
		oporné rameno 13 x 533 mm		125159-3	144,99 €

<b>Pásové brúsky</b> <span style="float: right;">*****</span>					
	9903, 9920, 9403	stojan na brúsku		193055-3	89,99 €
	9404	brúsny rám		193072-3	107,99 €
	9903	brúsny rám		193070-7	100,99 €
	9401, 9402	držiak brúsky		342332-2	3,29 €
	9910, 9911	upínacie svorky		192694-6	55,99 €
	9404, 9902, 9903, 9920	zberné vrečko na prach		122591-2	15,99 €
	9910, 9911	zberné vrečko na prach		122548-3	5,59 €
	9924DB	zberné vrečko na prach		122296-4	16,99 €
	9401, 9402	zberné vrečko na prach		122297-2	17,99 €
	9403	zberné vrečko na prach		122562-9	15,99 €

model	popis	Obj. č.	MOC s DPH	popis	Obj. č.	MOC s DPH	popis	Obj. č.	MOC s DPH
<b>Pásové brúsky</b> <span style="float: right;">*****</span>									
9401, 9402	oceľová doska	342328-3	1,71 €	korková doska	424058-9	1,47 €	grafitová doska	423029-3	4,84 €
9403	oceľová doska s korkom	150980-1	3,92 €	korková doska	424058-9	1,47 €	grafitová doska	424057-1	1,56 €
9404	oceľová doska s korkom	151751-9	9,00 €	korková doska	423314-4	1,69 €	grafitová doska	423317-8	3,48 €
9924DB				korková doska	423035-8	1,54 €	grafitová doska	423036-6	3,09 €
9902, 9903	oceľová doska s korkom	151749-6	2,72 €	korková doska	423312-8	1,11 €	grafitová doska	423315-2	7,49 €
9910, 9911	oceľová doska	345503-0	2,39 €						
9920	oceľová doska s korkom	151750-1	6,94 €				grafitová doska	423316-0	3,79 €

Tvar	Typ hlavy	Ø mm	pracovná dĺžka	upínanie	Obj. č.	MOC s DPH
------	-----------	------	----------------	----------	---------	-----------

## Brúsne fréžky pre priame brúsky

### Karbid volfránu

#### Použitie

##### Štandardná hlava

Vlastnosti: vysoká účinnosť

Hrubé opracovanie

Použitie: kov, nerez



##### Diamantová Hlava

Vlastnosti: menej vibrácií

Jemné opracovanie

Použitie: kov, nerez



##### Neželezné kovy

Vlastnosti: menej zanášania

Hrubé opracovanie

Použitie: neželezné kovy, PVC



#### Tvar hlavy

Tvar: SA



Tvar: SC



Tvar: SF



Tvar: SL



Tvar: SM



Clean the burrs on inox



Deburr of aluminium



Wipe the welding line between steel plate



SA	diamant	10	20	6	B-52722	18,99 €
SC	diamant	10	20	6	B-52750	18,99 €
SF	diamant	10	20	6	B-52788	17,99 €
SL	diamant	10	25	6	B-52819	17,99 €
SM	diamant	10	20	6	B-52847	18,99 €
SA	štandard	10	20	6	B-52716	17,99 €
SF	štandard	10	20	6	B-52772	19,99 €
SL	štandard	10	25	6	B-52803	17,99 €
SM	štandard	10	20	6	B-52831	19,99 €
SA	neželezné kovy	10	20	6	B-52738	18,99 €
SC	neželezné kovy	10	20	6	B-52766	17,99 €
SF	neželezné kovy	10	20	6	B-52794	17,99 €
SL	neželezné kovy	10	25	6	B-52825	19,99 €
SM	neželezné kovy	10	20	6	B-52853	18,99 €

model	klúč	upínanie	Obj. č.	
-------	------	----------	---------	--

## Klieštiny



DGD800, DGD801	13 mm 19 mm	3 mm	763669-8	21,99 €
		6 mm	763670-3	8,79 €
		8 mm	763671-1	18,99 €
		matica	763668-0	1,59 €
906	10 mm 17 mm	3 mm	763627-4	9,99 €
		6 mm	763620-8	6,99 €
GD0600, GD0601	13 mm x2	3 mm	763627-4	9,99 €
		6 mm	763620-8	6,99 €
		matica	763664-8	1,49 €
GD0603	10 mm x2	3 mm	763627-4	9,99 €
		6 mm	763620-8	6,99 €
		matica	763236-9	1,79 €
GD0602	13 mm x2	3 mm	763669-8	21,99 €
		6 mm	763670-3	8,79 €
		8 mm	763671-1	18,99 €
		matica	763668-0	1,59 €
GD0800/C, DGD800, DGD801, GD0810C, GD0801C, GD0811C	13 mm 19 mm	3 mm	*193011-3	26,99 €
		6 mm	*193012-1	19,99 €
		8 mm	*192988-9	26,99 €
		matica	763645-2	2,69 €

\*sada klieština + matica



# DVOJKOTÚČOVÉ BRÚSKY











## Brúsne kotúče k dvojkotúčovým brúskam



model	typ/ zrnitosť	použitie	rozmer (mm)	Obj. č.	MOC s DPH
	A36M	železo	150 x 16 x 12,7	B-51904	14,99 €
	A60M	železo	150 x 16 x 12,7	B-51910	14,99 €
GB602	GC120H	tenké plechy Cu,Ni,Ms,Zn	150 x 16 x 12,7	B-51932	18,99 €
GB602W	A60M	železo	150 x 6,4 x 12,7	B-51895	12,99 €
GB801	WA60K	Železo/herez	150 x 16 x 12,7	B-51926	16,99 €
	A36P	železo	205 x 19 x 15,88	B-51948	24,99 €
	A60P	železo	205 x 19 x 15,88	B-51954	24,99 €
	GC120H	tenké plechy Cu,Ni,Ms,Zn	205 x 19 x 15,88	B-51976	32,99 €
	WA60K	železo/herez	205 x 19 x 15,88	B-51960	26,99 €



# KEFOVÉ BRÚSKY

	popis	zrnitosť	Obj. č.	MOC s DPH
<b>Kotúče pre kefovú brúsku 9741</b>				
	lamelová brúsna kefa na brúsenie povrchov, odstraňovanie farieb a pod.	40	P-01127	76,99 €
	kefa z oceleového drôtu, potiahnutá mosadzou, 0,3 mm pre vysoký uber vhodná na štruktúrovanie dreva, na odrezávanie a čistenie		P-65648	129,99 €
	drôtená kefa na leštenie železných plôch	120	794382-7	146,99 €
	kefa z oceleového drôtu 0,3 mm na odstraňovanie rezu a farieb, na čistenie betónového debnenia		P-04400	136,99 €
	fibrová kefa na zapracovanie moridiel a lakov + na následné vyhladenie		P-04416	109,99 €
	bavlnená leštiaca kefa na leštenie povrchových plôch aj s pridaním zodpovedajúcich leštiacich pást		794381-9	225,99 €
	brúsna nylonová kefa na štruktúrovanie mäkkého dreva a na dopracovávanie štruktúrovaní starého dreva pre zvýraznenie štruktúry dreva a na odstraňovanie existujúcich drevených vlákien pre optimálnu prípravu plôch na lakovanie a morenie pre zhotovenie brúsneho obrazu na ušľachtilej oceli a hliníku	60	P-04422	128,99 €
		80	P-04438	128,99 €
		120	P-04444	128,99 €
		180	P-04450	128,99 €
		80	794384-3	174,99 €
	valcová kefa vlies na jemné štruktúrovanie ušľachtilej ocele a jemné brúsenie povrchových plôch dreva	80	P-18035	70,99 €
		120	P-18041	71,99 €
		180	P-18029	70,99 €
	valcová kombinovaná kefa leinen/vlies na jemné štruktúrovanie ušľachtilej ocele a jemné brúsenie povrchových plôch dreva	80	P-18057	79,99 €
		120	P-19233	78,99 €
		180	P-19249	80,99 €
	nástavec na odsávanie		410899-9	1,09 €

<b>Kotúče pre kefovú brúsku 9741</b>				
	oceľová kefa pre rýchly uber materiálu		D-73564	34,99 €
	oceľová kefa mosadzná úprava, pre brúsenie dreva a kovových materiálov		D-73570	34,99 €
	nylónová kefa na štruktúrovanie mäkkého a starého dreva, pre zvýraznenie štruktúr dreva pri príprave plôch pred lakovaním a morením a pre zhotovenie brúsneho obrazu ušľachtilej oceli a hliníku	60	D-73586	43,99 €
	nylónová kefa na štruktúrovanie mäkkého a starého dreva, pre zvýraznenie štruktúr dreva pri príprave plôch pred lakovaním a morením a pre zhotovenie brúsneho obrazu ušľachtilej oceli a hliníku	80	D-73592	42,99 €

# SPONKOVAČKY

typ	šířka (mm)	délka (mm)	ks/bal	vhodné pro stroj	Obj. č.	MOC s DPH
-----	------------	------------	--------	------------------	---------	-----------

## Spony pre AT638

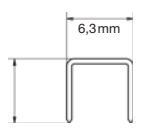

spony	6,3	25	5000	AT638	F-33607	30,99 €
spony	6,3	30	5000	AT638	F-33623	39,99 €
spony	6,3	32	5000	AT638	F-33636	36,99 €
spony	6,3	38	5000	AT638	F-33649	45,99 €

## Spony pre AT1150A

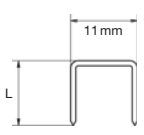

spony	11	25	10000	AT1150A	F-32078	168,99 €
spony	11	28	10000	AT1150A	F-32081	91,99 €
spony	11	32	10000	AT1150A	F-32094	134,99 €
spony	11	35	10000	AT1150A	F-32100	164,99 €
spony	11	40	10000	AT1150A	F-32113	101,99 €
spony	11	45	10000	AT1150A	F-32126	143,99 €
spony	11	51	10000	AT1150A	F-32139	157,99 €

## Spony pre AT2550A

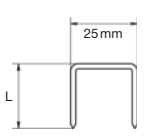

spony	25	25	10000	AT2550A	F-32023	96,99 €
spony	25	32	10000	AT2550A	F-32036	93,99 €
spony	25	38	10000	AT2550A	F-32049	157,99 €
spony	25	45	10000	AT2550A	F-32052	163,99 €
spony	25	51	10000	AT2550A	F-32065	198,99 €

## Spony pre T221/DST220BST/DST221

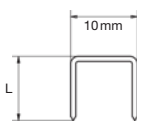

spona	10	8	5000		F-32917	11,99 €
spona	10	10	5000		F-32647	13,99 €
spona	10	13	5000		F-32650	14,99 €
spona	10	16	5000		F-32663	18,99 €
spona	10	19	5000		F-32676	23,99 €
spona	10	22	5000		F-32689	23,99 €

## Spony pre ST113/DST112

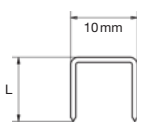

spona	10	7	2500		F-81518	48,99 €
spona	10	10	2500		F-81521	17,99 €



Akumulátory  
 Odkládacie systémy  
 Vŕtanie  
 Skrútkovanie  
 Brúsky  
 Pilenie  
 Frézovanie  
 Brúsenie  
 Klince / spony  
 Špeciálne stroje  
 Vysávanie  
 Fény/lampy  
 Záhrada  
 Ručné náradie  
 Ostatné

# KLINCOVAČKY

typ	typ drôtku	šířka (mm)	délka (mm)	ks/bal	Vhodné pro stroj	Obj. č.	MOC s DPH
-----	------------	------------	------------	--------	------------------	---------	-----------

## Klince pre AN450, AN454 (klince páskované pod 16° uhlom)

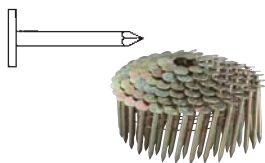

klince spájané drôtom	hladký	3,1	32	7200	AN450, AN454	F-30788	117,99 €
klince spájané drôtom	hladký	3,1	45	7200	AN450, AN454	F-30807	62,99 €

## Klince pre AN560, AN611, AN621, AN635H, AN760, AN901, AN902, AN935H, AN953H

(klince páskované pod 16° uhlom)

klince spájané drôtom	hladký	2,5	45	10800		F-30810	134,99 €
klince spájané drôtom	hladký	2,5	50	10800		F-31243	205,99 €

## Klince pre AN611, AN621, AN635H, AN760, AN901, AN902, AN935H, AN953H, AN960, AN961

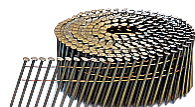

klince spájané drôtom	hladké	2,5	65	8100		F-30900	61,99 €
klince spájané drôtom	skrutkovité	2,5	65	8100		F-31269	154,99 €

## Klince pre AN560, AN611, AN621, AN635H, AN760, AN901, AN902, AN935H, AN953H

klince spájané drôtom	skrutkovitý	2,9	50	9000		F-30971	160,99 €
-----------------------	-------------	-----	----	------	--	---------	----------

## Klince pre AN611, AN621, AN635H, AN760, AN901, AN902, AN935H, AN953H, AN960, AN961

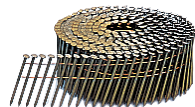

klince spájané drôtom	skrutkovitý	2,9	57	6750		F-30881	129,99 €
klince spájané drôtom	hladký	3,3	65	6750		F-30852	82,99 €

## Klince pre AN760, AN901, AN902, AN935H, AN953H, AN960, AN961

(klince páskované pod 16° uhlom)

klince spájané drôtom	skrutkovitý	3,2	75	4050		F-31320	146,99 €
-----------------------	-------------	-----	----	------	--	---------	----------

## Klince pre AN901, AN902, AN935H, AN953H, AN960, AN961

(klince páskované pod 16° uhlom)

klince spájané drôtom	hladký	3,1	90	4050		F-31317	107,99 €
klince spájané drôtom	skrutkovitý	3,2	90	4050		F-31346	114,99 €
klince spájané drôtom	hladký	3,8	90	2700		F-31362	144,99 €

typ	typ drieku	šírka (mm)	dĺžka (mm)	ks/bal	Vhodné pre stroj	Obj. č.	MOC s DPH
-----	------------	------------	------------	--------	------------------	---------	-----------

### Klince pre AN560, AN611, AN621, AN635H, AN760, AN901, AN935H

(klince D s hladkým driekom, páskované papierom pod 34° uhlom)

klince spájané drôtom	hladký	2,1	45	18000		F-32782	111,99 €
-----------------------	--------	-----	----	-------	--	---------	----------

### Klince pre AN943



páskované papierom	hladký	3,1	83	3000		F-30601	96,99 €
páskované papierom	hladký	3,3	90	3000		F-30656	86,99 €

### Klince pre AF505, AF506, DBN500, FN001G, DFN350

DFN350 klince len do dĺžky 35 mm (kolárske klince)

FN001G klince len do dĺžky 40 mm



kolárske klince	hladký	1	20	5000		P-45923	12,99 €
kolárske klince	hladký	1	25	5000		P-45939	14,99 €
kolárske klince	hladký	1	30	5000		P-45945	16,99 €
kolárske klince	hladký	1	40	5000		P-45951	19,99 €
kolárske klince	hladký	1	50	5000		P-45967	23,99 €
kolárske klince	hladký	1	15	5000		F-31867	11,99 €
kolárske klince	hladký	1	20	5000		F-31870	14,99 €
kolárske klince	hladký	1	25	5000		F-31883	17,99 €
kolárske klince	hladký	1	30	5000		F-31896	17,99 €
kolárske klince	hladký	1	35	5000		F-31915	24,99 €
kolárske klince	hladký	1	38	5000		F-31928	20,99 €
kolárske klince	hladký	1	40	5000		F-31931	25,99 €
kolárske klince	hladký	1	45	5000		F-31944	28,99 €
kolárske klince	hladký	1	50	5000		F-31957	32,99 €

# SPONKOVAČKY

typ	typ drôtku	šírka (mm)	dĺžka (mm)	ks/bal	vhodné pre stroj	Obj. č.	MOC s DPH
-----	------------	------------	------------	--------	------------------	---------	-----------

## Klince pre AF353, AF201Z, BPT/DPT350, BPT/DPT351, DPT353, PT354, PT001G

(klince bez hlavičky – pinky)



klince – pinky	hladký	0,6	18	10000		F-31825	14,99 €
klince pozink	hladký	0,6	18	10000		F-32142	29,99 €
klince – pinky	hladký	0,6	25	10000		F-31838	14,99 €
klince pozink	hladký	0,6	25	10000		F-32155	38,99 €
klince – pinky	hladký	0,6	30	10000		F-31841	21,99 €
klince pozink	hladký	0,6	30	10000		F-32168	43,99 €
klince – pinky	hladký	0,6	35	10000		F-31854	18,99 €
klince pozink	hladký	0,6	35	10000		F-32171	48,99 €

## Klince pre AN621



klince spájané drôtom	krúžok	2,5	45	9000		P-51487	87,99 €
klince spájané drôtom	krúžok	2,5	64	9000		P-51502	103,99 €
klince spájané drôtom	krúžok	2,5	50	9000		P-51493	127,99 €

## Klince pre AN901



klince spájané drôtom	krúžok	2,8	65	5000		P-51524	80,99 €
klince spájané drôtom	krúžok	2,8	75	5000		P-51530	98,99 €
klince spájané drôtom	krúžok	3,1	90	4500		P-51552	105,99 €

model	popis	rozmer	Obj. č.	MOC s DPH
-------	-------	--------	---------	-----------

## Ďalšie príslušenstvo ku sponkovačkám/klincovačkám

AN621, AN911, AN510H, AN610, AN620H, AN711H, AN911H	vsuvka H22PN		243105-5	13,78 €
AN902, AN901, AN621, AT1150, AT2250, AT638, AF201Z, AF505, AF506	vsuvka	1/2"	HY00000080	2,00 €
AN621, AN911, AN510H, AN610, AN620H, AN711H, AN911H, AT638, AT1150, AT2250	kompresorová vsuvka	1/4"	P-45989	25,99 €
AN943	kompresorová vsuvka	3/8"	243104-7	6,09 €
AT1150, AT2250, AF201, AN621, AN911, AN943	kompresorová hadica	ø 8 mm 15 m	P-45973	84,99 €
AN450, AN610, AN620, AN711, AN911	vysokotlaková hadica	7,5 m	B-80036	190,99 €
AN450, AN610, AN620, AN711, AN911	vysokotlaková hadica	15 m	B-80014	236,99 €
pre všetky klincovačky a sponkovačky	olej	30 ml	181434-7	1,79 €

# PRÍSLUŠENSTVO PRE ŠPECIÁLNE STROJE MAKITA

## Príslušenstvo pre BCG/DCG180, CG100

A: 300 ml



C: 800 ml



B: 600 ml



D: 400 ml



typ	popis	Obj. č.	MOC s DPH
A	300 ml set	196351-8	45,99 €
B	600 ml set	1911T4-0	123,99 €
C	800 ml set	197195-9	71,99 €
D	400 ml set	191P89-6	97,99 €
A	držák 300 ml	454275-7	8,22 €
A	matica	454223-6	2,30 €
A	ozubené tiahlo	142041-1	33,16 €
B	tryska	454226-0	2,19 €
A, B	piestik	142071-2	2,58 €
A, B	piestik	142072-0	3,91 €
C	piestik	123221-8	18,18 €

ø (mm)	ks/bal	popis	Obj. č.	MOC s DPH
--------	--------	-------	---------	-----------

## Príslušenstvo pre Aku viazač armatúr DTR180

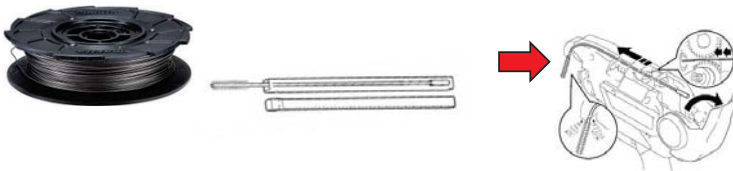

0,8	50	žiháný viazač drôt	199137-9	223,99 €
0,8	50	žiháný viazač drôt pozink	191A57-9	307,99 €
	1	kefka čistiaci	162755-6	29,99 €
	1	predženie	191M27-0	230,99 €

popis	Obj. č.	MOC s DPH
-------	---------	-----------

## Príslušenstvo pre AKU kompresory DMP180, DMP181, MP001, MP100D



adaptér pre francúzske ventily	TE00000594	1,69 €
adaptér na lopty, nafukovačky	TE00000333	1,51 €
adaptér na lopty	TE00000592	1,56 €
adaptér pre anglické ventily	TE00000597	1,91 €
nadstavec na fúkanie kolies zahnutý	TE00000691	24,99 €
nadstavec na fúkanie kolies rovný	TE00000796	28,99 €
hadica	TE00000345	15,29 €

## Príslušenstvo pre Aku maznicu DGP180

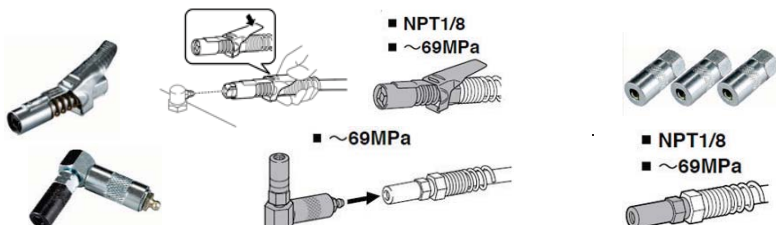

maznica s poistkou	191A76-5	206,99 €
maznica uhlová	191A77-3	119,99 €
sada mazníc 3 ks	191W60-2	32,99 €
hadica 0,6 m	191W59-7	53,99 €
hadica 1,2 m	191W58-9	54,99 €

tuba pre kartuše a ručné plnenie 400 g	1910X0-0	91,99 €
tuba pre kartuše a ručné plnenie 450 g	191A81-2	cena na vyžiadanie
tuba pre 450 g kartuše	191F25-2	cena na vyžiadanie
tuba pre 500 g kartuše	191F27-8	64,99 €

Akumulátory  
 Odkládacie systémy  
 Vŕtanie  
 Skrútkovanie  
 Brúsky  
 Pilenie  
 Frézovanie  
 Brúsenie  
 Klince / spony  
 Špeciálne stroje  
 Vysávanie  
 Fény/lampy  
 Záhrada  
 Ručné náradie  
 Ostatné

# PRISLÚŠENSTVO PRE DIEROVAČ DPP200

Ø (mm)	obj.č	MOC s DPH	Ø (mm)	obj.č	MOC s DPH	mäkká ocel	Nehrdzavajúca ocel
--------	-------	-----------	--------	-------	-----------	------------	--------------------

razník

matrica

hrúbka materiálu

## Okrúhle dierovanie



6	SC05340040	118,99 €	SB6	SC00000203	117,99 €	t2-t4	t3-t4
8	SC05340060	112,99 €	SB8	SC00000207	112,99 €	t2-t6	t3-t4
10	SC05340080	116,99 €	SB10	SC00000211	113,99 €	t2-t6	t3-t4
12	SC05340100	117,99 €	SB12	SC00000215	153,99 €	t2-t8	t3-t6
14	SC05340120	116,99 €	SB14	SC00000219	117,99 €	t2-t8	t3-t6
15	SC05340130	116,99 €	SB15	SC00000221	117,99 €	t2-t8	t3-t6
16	SC05340140	111,99 €	SB16	SC05332710	114,99 €	t2-t8	t3-t6
18	SC05340150	116,99 €	SB18	SC00000223	116,99 €	t2-t8	t3-t6
19	SC05340170	cena na vyžiadanie	SB19	SC05332740	cena na vyžiadanie	t2-t8	t3-t6
20	SC05340160	111,99 €	SB20	SC05352510	108,99 €	t2-t8	t3-t6

razník

matrica

hrúbka materiálu

## Oválne dierovanie



6.5 × 10	SC05340200	158,99 €	6.5 × 10B	SC00000244	117,99 €	t2-t6	t3-t4
6.5 × 13	SC05340210	158,99 €	6.5 × 13B	SC00000246	117,99 €	t2-t6	t3-t4
8.5 × 13	SC05340220	158,99 €	8.5 × 13B	SC00000248	117,99 €	t2-t6	t3-t4
8.5 × 17	SC05340230	157,99 €	8.5 × 17B	SC00000250	116,99 €	t2-t6	t3-t4
9 × 13.5	SC05340240	158,99 €	9 × 13.5B	SC00000252	117,99 €	t2-t6	t3-t4
9 × 18	SC05340250	158,99 €	9 × 18B	SC00000254	117,99 €	t2-t6	t3-t4
10 × 15	SC05340260	158,99 €	10 × 15B	SC00000256	117,99 €	t2-t8	t3-t6
10 × 20	SC05340270	152,99 €	10 × 20B	SC00000258	117,99 €	t2-t8	t3-t6
11 × 16.5	SC05340280	159,99 €	11 × 16.5B	SC00000260	117,99 €	t2-t8	t3-t6
12 × 18	SC05340290	158,99 €	12 × 18B	SC00000262	117,99 €	t2-t8	t3-t6
13 × 19.5	SC05340300	159,99 €	13 × 19.5B	SC00000264	117,99 €	t2-t8	t3-t6
14 × 21	SC05340310	158,99 €	14 × 21B	SC00000266	117,99 €	t2-t8	t3-t6



## Príslušenstvo pre Aku nitovačky DRV150 / DRV250

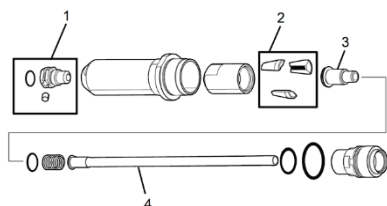

ø (mm)	typ	popis	Obj. č.	MOC s DPH
2,4	1	hlavička	127230-9	cena na vyžiadanie
	3	posúvač čeluste	127478-3	cena na vyžiadanie
	4	rúrka prepadu	162747-5	cena na vyžiadanie
	2	čeluste set 3 ks	199731-7	22,99 €
3,2	1	hlavička	127229-4	cena na vyžiadanie
	3	posúvač čeluste	127477-5	cena na vyžiadanie
	4	rúrka prepadu	162746-7	cena na vyžiadanie
	2	čeluste set 3 ks	199731-7	22,99 €
4,0	1	hlavička	127228-6	20,00 €
	3	posúvač čeluste	127476-7	cena na vyžiadanie
	2	čeluste set 3 ks	199731-7	22,99 €
	4,8	1	hlavička	127225-2
3		posúvač čeluste	127475-9	7,60 €
2		čeluste set 3 ks	199731-7	22,99 €
2,4		1, 3, 4	sada	199729-4
3,2	1, 3, 4	sada	1911U4-7	33,99 €
4,0	1, 3, 4	sada	191C04-2	17,99 €
4,8	1, 3, 4	sada	191C03-4	16,99 €

## Príslušenstvo pre Aku nitovačky DRV250

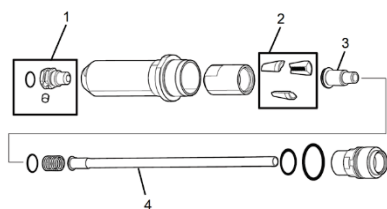

2,4	1	hlavička	127230-9	cena na vyžiadanie	
	3	posúvač čeluste	127478-3	cena na vyžiadanie	
	4	rúrka prepadu	162747-5	cena na vyžiadanie	
	2	čeluste set 3 ks	199731-7	22,99 €	
3,2	1	hlavička	127229-4	cena na vyžiadanie	
	3	posúvač čeluste	127477-5	cena na vyžiadanie	
	4	rúrka prepadu	162746-7	cena na vyžiadanie	
	2	čeluste set 3 ks	199731-7	22,99 €	
4,0	1	hlavička	127228-6	20,00 €	
	3	posúvač čeluste	127476-7	cena na vyžiadanie	
	2	čeluste set 3 ks	199731-7	22,99 €	
	4,8	1	hlavička	127225-2	19,29 €
3		posúvač čeluste	127475-9	7,60 €	
4		rúrka prepadu	162744-1	cena na vyžiadanie	
2		čeluste set 3 ks	199731-7	22,99 €	
6,0	1	hlavička	127224-4	cena na vyžiadanie	
			199730-9	26,99 €	
	3	posúvač čeluste	127474-1	cena na vyžiadanie	
	4	rúrka prepadu	162744-1	cena na vyžiadanie	
6,4	2	čeluste set 3 ks	199730-9	26,99 €	
	1	hlavička	127223-6	22,75 €	
	3	posúvač čeluste	127473-3	7,73 €	
	4	rúrka prepadu	162743-3	17,51 €	
6,4	2	čeluste set 3 ks	199730-9	26,99 €	
			199730-9	26,99 €	
	2,4	1, 3, 4	sada	199729-4	33,99 €
	3,2	1, 3, 4	sada	1911U4-7	33,99 €
4,0	1, 3, 4	sada	191F80-4	63,99 €	
4,8	1, 3, 4	sada	191C03-4	16,99 €	
			191F79-9	35,99 €	
6,0	1, 3, 4	sada	199725-2	29,99 €	
6,4	1, 3, 4	sada	191C02-6	cena na vyžiadanie	



popis	Obj. č.	MOC s DPH
-------	---------	-----------

## AS001G príslušenstvo



Dýza fúkacia 3 mm	191X11-1	2,09 €
Dýza fúkacia 7 mm	191X13-7	2,39 €
Dýza fúkacia 13 mm	191X15-3	2,49 €
Dýza tenká, vhodná na fúkanie plážových lôpt, nafukovačiek	191X17-9	3,49 €
Dýza široká	191X19-5	6,09 €
Ofukovacia hadička s tryskou, dĺžka 0,8 m, hrúbka 6 mm	191X21-8	13,99 €
Predlžovacia flexi hadica	191X23-4	16,99 €
Gumová dýza, vhodná na ofukovanie	191X25-0	4,69 €
Adaptér 65 mm	191X27-6	5,59 €
Filter, vhodný pri práci v prašnom prostredí	191X29-2	4,39 €
Dýza dlhá tenká štrbinová 8 mm	191X78-2	cena na vyžiadanie

## LASERY

### Príslušenstvo pre Lasery



statív 1000 – 2700 mm (5,8" upínanie)	P-81315	336,99 €
statív 400-1100 mm so závitom 5/8"	TK0LM2000F	51,99 €
meracia tyč hliniková (4 m)	P-81309	84,99 €

### SK102 / SK103 / SK104 / SK105 / SK106

nástenný držiak vrátane 1/4" skrutky	LE00785637	136,99 €
--------------------------------------	------------	----------

### SK102Z, SK103PZ, SK104Z



magnetický držiak s 5/8" a 1/4" adaptérom	LE00785633	18,99 €
kĺbový adaptér 1/4" na 1/4"	LE00785519	25,99 €

### SK102Z, SK103PZ, SK104Z, SK700, SK700D



USB Power Supply Cable – SK105/SK106	199178-5	11,99 €
prijímač LDX1	LE00855702	296,99 €
magnetický terč	LE00785638	24,79 €

### SKR200



prijímač	LE00796587	477,99 €
magnetický držiak	LE00784968	75,99 €
držiak na stenu s 5/8" skrutkou	LE00791661	118,99 €

### SK312GD

napájací kábel USB	199010-3	12,99 €
--------------------	----------	---------

# PRÍSLUŠENSTVO ELEKTRICKÉ VYSÁVAČE

Obj. č.	MOC, s DPH	ks/bal	typ	VC4210L/M	VC3511L/M	VC2000/VC2010 VC2511/VC2012 VC3512/VC3011	VC3211ML VC3210L/ VC3211H	VC3012L/M	446	447L/M	440, 448
---------	------------	--------	-----	-----------	-----------	---	---------------------------------	-----------	-----	--------	----------

## Vrecká do elektrických vysávačov



W107418353	42,99 €	5	vrecko na prach z netkanej textilie	•							
W107418354	226,99 €	1	vrecko na prach z netkanej textilie na opakované použitie	•							
P-78293	41,99 €	5	vrecko na prach papierové		•						
P-72899	34,99 €	5	vrecko na prach z netkanej textilie			•					•
P-84078	39,99 €	5	vrecko na prach z netkanej textilie					•			
P-70194	44,99 €	5	vrecko na prach papierové						•		•
195558-3	29,99 €	5	vrecko na prach z netkanej textilie				•				
P-70203	79,99 €	5	vrecko na prach papierové							•	
195440-6	10,99 €	10	vrecko PVC				•				
P-70297	45,99 €	5	vrecko PVC			•			•		•
P-70306	58,99 €	5	vrecko PVC							•	
W107418355	34,99 €	5	vrecko PVC	•							

## Filtere do elektrických vysávačov



P-70219	44,99 €	1	filter kartuš		•	•			•		
P-70225	85,99 €	1	filter kartuš							•	
W107418352	38,99 €	1	filter motora	•							
196251-2	19,44 €	1	prachový, suché vysávanie				•				
W107418351	76,99 €	1	hepa filter	•							

\*len pre model VC3210; \*\* okrem modelu VC3210

## Hubice pre elektrické vysávače



P-81789	23,99 €	1	hubica na koberce 35 x 300 mm	•					•		
W107402706	15,99 €	1	hubica na koberce 35 x 260 mm			•					
W14295	3,39 €	1	hubica na vankúše			•					
W107417892	90,99 €	1	hubica univerzálna		•	•			•	•	
P-70471	13,99 €	1	hubica s kefou		•	•			•	•	
195551-7	32,99 €	1	hubica univerzálna mokré/suché vysávanie				•				
191657-9	12,99 €	1	hubica s kefou tvar „O“		•	•			•	•	
60279B0N	10,99 €	1	kefa kobercová pre základňu 60277BON						•	•	
410306-2	2,19 €	1	hubica štrbinová 330 mm				•				
W6084	4,99 €	1	hubica štrbinová 35 x 300 mm			•			•	•	
P-72964	90,99 €	1	hubica na mokré vysávanie			•				•	

## Rúry pre elektrické vysávače



W107418350	38,99 €	3	rúra vysávača 36 x 350 mm, chrómová	•	•	•			•	•	
192562-3	8,99 €	1	rúra vysávača rovná, hliník				•				
192563-1	9,49 €	1	rúra vysávača ohnutá, hliník				•				
P-72942	34,99 €	2	rúra vysávača 36 x 520 mm, kov		•	•			•	•	
P-70437	54,99 €	2	rúra vysávača 36 x 515 mm, chrómová	•	•	•			•	•	

## Rukoväte pre elektrické vysávače







P-70346	37,99 €	1	rukoväť ohnutá 36 mm, chróm	•					•	•	
P-72908	28,99 €	1	rukoväť s reguláciou			•					
W107413340	20,99 €		rukoväť s reguláciou pre hadicu P-81739		•	•	•				









## Hadice pre elektrické vysávače





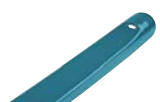

02300B0N	72,99 €	1	hadica ø 25 mm x 3 m								•
01319B0N	72,99 €	1	hadica ø 45 mm x 4 m								•
195433-3	63,99 €	1	hadica ø 28 mm x 3,5 m				•				
195434-1	68,99 €	1	hadica ø 38 mm x 2,5 m				•				
P-70487	97,99 €	1	hadica ø 27 mm x 3,5 m						•	•	
W15365	69,99 €	1	hadica s adaptérom P-70421, ø 36 mm x 4 m						•	•	
192108-5	26,99 €	1	hadica ø 19 mm x 2,5 m								•
P-84084	80,99 €	1	hadica ø 32 mm x 4 m	•					•		
P-70487	97,99 €	1	hadica antistatická ø 27 mm x 3,5 m			•			•	•	
P-70362	151,99 €	1	hadica antistatická ø 36 mm x 3 m			•			•	•	
P-72914	82,99 €	1	hadica s integrovanou rukoväťou quick systém ø 32 mm x 3 m			•			•	•	
P-72920	45,99 €	1	hadica s integrovanou rukoväťou quick systém ø 36 mm x 3 m			•			•	•	
P-81739	42,99 €	1	hadica s integrovanou rukoväťou quick systém ø 32 mm x 3,5 m		•	•	•				
01316B0N	61,99 €	1	hadica s integrovanou rukoväťou ø 45 mm x 2 m								•

# PRÍSLUŠENSTVO PRE AKU TYČOVÉ VYSÁVAČE

Obj. č.	MOC s DPH	ks/bal	typ	DCL284/ CL07G	DCL288/ CL02G	DCL288/ CL023G	CL070	CL108	CL107	CL108	CL114	CL117	DCL180/181	DCL182	DCL280/283	DVC360 /C01G
	191D73-9	46,99 €	1													
	191D75-5	33,99 €	1													
	443060-3	0,52 €	1													
	199966-0	10,98 €	1													
	451208-3	0,98 €	1													
	199989-8	7,79 €	1													
	198745-3	4,09 €	5													
	166084-9	1,12 €	1													
	191T96-3	21,99 €	10													
	191E39-5	14,53 €	1													

Hubice	Obj. č.	MOC s DPH	ks/bal	typ	DCL284/ CL07G	DCL288/ CL02G	DCL288/ CL023G	CL070	CL108	CL107	CL108	CL114	CL117	DCL180/181	DCL182	DCL280/283	DVC360 /C01G
	198532-0	28,99 €	1	podlahová / kobercová (biela)													
	198149-9	13,99 €	1	podlahová / kobercová (maslová)													
	198527-3	48,99 €	1	podlahová / kobercová (modrá)													
	A-59950	66,99 €	1	podlahová (biela)													
	122520-5	6,39 €	1	podlahová (maslová)													
	123486-2	10,99 €	1	podlahová (biela)													
	123488-8	12,99 €	1	podlahová (modrá)													
	199038-1	8,29 €	1	hubica na čalúnený nábytok (biela)													
	199041-2	8,49 €	1	hubica na čalúnený nábytok (modrá)													
	140H95-0	5,99 €	1	hubica na čalúnený nábytok 120 mm (modrá)													
	459056-4	2,59 €	1	hubica na auto koberce 120 mm (modrá)													
	191M30-1	12,99 €	1	kefa na hrubé nečistoty (čierna)													
	413859-0	1,49 €	1	nadstavec štrbinový (modrá)													
	198990-0	2,99 €	1	nadstavec štrbinový 330 mm (modrá)													
	198552-4	5,09 €	1	hubica tvar O (maslová)													
	198553-2	5,39 €	1	hubica tvar O (modrá)													
	191D67-4	7,29 €	1	hubica tvar O (šedá)													
	140H94-2	4,49 €	1	hubica tvar O dlhá 360°d (modrá)													
	198537-0	4,99 €	1	kefa úzka podlhovastá (maslová)													

Rúry vysávania	Obj. č.	MOC s DPH	ks/bal	typ	DCL284/ CL07G	DCL288/ CL02G	DCL288/ CL023G	CL070	CL108	CL107	CL108	CL114	CL117	DCL180/181	DCL182	DCL280/283	DVC360 /C01G
	140G19-0	25,99 €	1	rúra teleskopická hliník (590-942)													
	191D77-1	7,29 €	1	rúra plastová 340 mm (čierna)													
	123584-2	19,99 €	1	rúra teleskopická PVC 500-850 mm (biela)													
	451424-7	1,89 €	1	rúra plastová 465 mm (maslová)													
	191D80-2	4,69 €	1	rúra plastová 340 mm (čierna)													
	198544-3	7,19 €	1	rúra flexi 440-1140 mm (maslová)													

Držiaky	Obj. č.	MOC s DPH	ks/bal	typ	DCL284/ CL07G	DCL288/ CL02G	DCL288/ CL023G	CL070	CL108	CL107	CL108	CL114	CL117	DCL180/181	DCL182	DCL280/283	DVC360 /C01G
	458571-5	5,09 €	1	držiak na stenu													

# PRÍSLUŠENSTVO PRE AKU PODLAHOVÉ A CHRBTOVÉ VYSÁVAČE

	popis	Obj. č.	MOC s DPH
--	-------	---------	-----------

## Príslušenstvo pre DVC750



hubica štrbinová dlhá	410306-2	2,19 €
hubica v tvare O	191657-9	12,99 €
hadica ø 28 mm x 2 m	140G04-3	10,09 €
popruh ramenný	199486-4	7,69 €
adaptér ø 38 mm	418500-0	3,88 €
HEPA filter	162518-0	26,98 €
nylónový predfilter	162635-6	16,10 €
filter na mokré vysávanie	191M39-3	18,99 €

## Príslušenstvo pre DCL184/CL121



1 x textilné vrecko na prach	166084-9	1,12 €
5 x papierové vrecko na prach	198745-3	4,09 €
Nástavec s kefou 360°	140H94-2	4,49 €
Hubica na čalúnenie	140H95-0	5,99 €
Jednoramenný popruh	162544-9	5,19 €
Hubica na auto koberce	459056-4	2,59 €
Nástavec fukára	140J64-3	10,99 €

Obj. č.	MOC s DPH	ks/bal	typ	DVC261, 285	DVC660, 665, VC011G	DVC150, 155, 157	VC003G, VC004G, VC005G	VC006G, VC009G	VC008GM, VC007GL
---------	-----------	--------	-----	-------------	---------------------	------------------	------------------------	----------------	------------------

## Filtere, sáčky

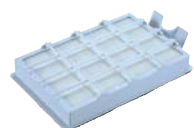













191C26-2	20,99 €	10	textilné vrecko na prach 6 l		•				
191C30-1	17,99 €	1	vrecko na opakované použitie 5,5 l		•				
197903-8	19,99 €	10	textilné vrecko na prach 2 l	•				•	
197899-3	26,99 €	1	vrecko na opakované použitie 1,5 l	•				•	
195432-5	9,89 €	10	igelitové vrecko na prach 45			•	•		
195557-5	26,99 €	5	textilné vrecko na prach 15 l			•	•		
1910Y4-9	39,99 €	5	textilné vrecko na prach 35 l					•	
1910R3-2	18,99 €	10	igelitové vrecko na prach 45					•	
191Y27-2	15,99 €	1	HEPA filter					•	
127725-2	12,00 €	1	HEPA filter	•					
191D12-9	17,42 €	1	HEPA filter		•				
191V70-3	42,67 €	1	HEPA filter s krytom				•		
197166-6	58,99 €	1	HEPA filter			•			
1911B7-8	43,43 €	1	HEPA filter					•	
191V69-8	61,60 €	1	pred filter nylónový				•		
195553-3	23,99 €	1	pred filter nylónový			•			
1911B5-2	15,99 €	1	pred filter nylónový					•	
144625-1	22,99 €	1	filter látkový				•		
191V71-1*	42,40 €	1	filter látkový				•		
140248-3	14,99 €	1	filter látkový			•			
191V68-0	14,04 €	1	pred filter penový				•		
1911B4-4	4,49 €	1	pred filter penový					•	

\* len pre použitie s modelom VC005G

# PRÍSLUŠENSTVO PRE AKU PODLAHOVÉ A CHRBTOVÉ VYSÁVAČE

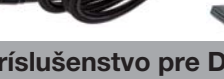
Obj. č.	MOC s DPH	ks/bal	typ	DVC261, 265	DVC860, 865, VC011G	DVC150, 155, 157	VC003G, VC004G, VC005G	VC006G, VC009G	VC006GM, VC007GL
<b>Hubice</b>									
	195551-7	32,99 €	1	hubica univerzálna mokré/suché vysávanie	•	•	•	•	•
	191G86-8	34,99 €	1	hubica suché vysávanie			•	•	•
	195549-4	24,99 €	1	hubica suché vysávanie	•	•	•	•	•
	195550-9	19,99 €	1	hubica mokré vysávanie	•	•	•	•	•
	123486-2	10,99 €	1	hubica podlahová	•				
	127082-8	34,99 €	1	hubica podlahová	•	•			
	A-59950	66,99 €	1	hubica podlahová	•				
	197901-2	7,09 €	1	mäkká gumová hubica	•	•	•	•	•
	191657-9	12,99 €	1	okružlá kefa	•	•	•	•	•
	410306-2	2,19 €	1	nadstavec štrbinový	•	•	•	•	•

<b>Rúry vysávania</b>									
	127093-3	13,99 €	1	rukoväť pre hadice 28 mm quick systém	•	•	•	•	•
	126756-8	10,99 €	1	rukoväť pre hadice 28 mm	•	•	•	•	•
	140G19-0	25,99 €	1	rúra teleskopická hliník pre hadice 28 mm Quick systém 590-942 mm	•	•	•	•	•
	123584-2	19,99 €	1	rúra teleskopická PVC pre hadice 28 mm 500-850 mm (biela)	•	•	•	•	•
	A-34235	31,99 €	1	hadica flexi 28 mm, 1,5 m, s adaptérmý 22 a 38 mm,	•	•	•	•	•
	195433-3	63,99 €	1	hadica flexi 28 mm, 3,5 m, s adaptérmý 22, 24, 38 mm,	•	•	•	•	•
	195436-7	85,99 €	1	hadica flexi 28 mm, 5 m, s adaptérmý 22, 24, 38 mm,	•	•	•	•	•
	195434-1	68,99 €	1	hadica flexi 38 mm, 2,5 mm	•	•	•	•	•
	192562-3	8,99 €	1	rukoväť hliník pre hadice 38 mm	•	•	•	•	•
	192563-1	9,49 €	1	rúra hliník pre hadice 38 mm	•	•	•	•	•
	195439-1	118,99 €	1	set (hadica 38 mm, rúra rovná, zahnutá, hubica podlahová, štrbinový nadstavec)	•	•	•	•	•
	1912G4-5	33,99 €		rúra teleskopická hliník Ø 38 mm Quick systém	•	•	•	•	•
	1912G5-3	13,99 €		rukoväť pre hadice 38 mm Quick systém	•	•	•	•	•

## SADY

	Obsah sady	Obj. č.	MOC s DPH
<b>Príslušenstvo pre vysávanie pre vysávače 446L, 447L a VC2010L / VC2511 / VC3511 L</b>			
	1. predĺžovacia trubica 2ks 2. otočná prípojka chrómovaná 3. hubica kobercová 4. štrbinová hubica 5. hubica na vankúše 6. hubica na vankúše 7. plastový držiak	P-70312	116,99 €
	1. predĺžovacia trubica 2ks 2. otočná prípojka chrómovaná 3. hubica podlahová 4. hadica priem. 36mm, 4m	P-70328	142,99 €
	1. predĺžovacia trubica 2ks 2. hadica priem. 27 mm, 3m s prípojkou 3. hubica podlahová 4. štrbinová hubica 5. hubica s kefou 6. hubica na vankúše	W302002734	101,99 €

## Príslušenstvo pre DRC300



bočná kefa na tatami	191P26-0	15,99 €
bočná kefy na podlahy	191P28-6	12,99 €
hlavná kefa na podlahy	191P22-8	37,99 €
hlavná kefa na tatami	191P20-2	45,99 €
magnetická páska na ohraničenie 5 m	191P18-9	50,99 €
penová ochrana proti poškodeniu	191X35-7	14,99 €

## Príslušenstvo pre DRC200Z



páska na vytýčenie hranice (15 m rolka)	SH00000231(EU)	57,99 €
bočné kefy	SH00000065	67,91 €
výkonná kefa	SH00000313	129,95 €
kryt rotačnej kefy	SH00000314	64,44 €
filter	SH00000213	112,18 €

# ROZMERY ADAPTÉROV NA ODSÁVANIE



popis	poznámka	Ø adaptéru (mm)	pre vysávač	Obj. č.	MOC s DPH
-------	----------	-----------------	-------------	---------	-----------

## Adaptéry na hadice vysávačov



adaptér hadice (k vysávaču)	pre hadicu P-70362 a P-72920, Ø 36 mm	58	446L, 447L, VC2010L, VC2511, VC3511L	P-70390	16,99 €
adaptér ku stroju antistatický (použiteľný s krúžkom 213419-6)	pre hadicu s rýchlopínaním	25/38	446L, 447L, VC2010L, VC2511, VC3511L	P-70378	30,99 €
adaptér ku stroju antistatický (použiteľný s krúžkom 213419-6)	pre hadicu s rýchlopínaním	38	446L, 447L, VC2010L, VC2511, VC3511L, VC4210L/M	W107418688	34,99 €
adaptér ku stroju antistatický (použiteľný s krúžkom 213419-6)	pre hadicu P-70487, Ø 27 mm	37/45	446L, 447L, VC2010L, VC2511, VC3511L	P-70415	10,99 €
O krúžok	pre adaptéry ku strojom			213419-6	2,22 €
antistatický adaptér	pre hadicu P-70487, Ø 27 mm	25/38	446L, 447L, VC2010L, VC2511, VC3511L	P-70421	25,99 €
adaptér	pre hadicu P-72914, Ø 32 mm	25/38	446L, 447L, VC2010L, VC2511, VC3511L	P-72936	12,99 €
adaptér 22	pre hadicu 195433-3, Ø 28 mm	22	VC3210LX1, BCV340, BCV350	195547-8	2,29 €
adaptér ku stroju 24	pre hadicu 195433-3, Ø 28 mm	24	VC3210LX1, BCV340, BCV350	195546-0	3,29 €
adaptér 38	pre hadicu 195433-3, Ø 28 mm	38	VC3210LX1, BCV340, BCV350	195545-2	6,09 €
adaptér 22	pre hadicu 195433-3 priemer 28 mm	22	VC3210, VC3211, BCV340, BCV350, DVC860L, VC2211M	195547-8	2,29 €
adaptér 22	pre hadicu 195433-3 priemer 28 mm	24	VC3210, VC3211, BCV340, BCV350, DVC860L, VC2211M	195546-0	3,29 €
adaptér s reguláciou	pre hadicu P-81739 priemer 32 mm	25/38	VC2012L, VC2512L, VC3011L	P-81745	22,99 €
adaptér ku stroju	pre hadicu Ø 32 mm	32/22	VC2012L, VC2512L, 3011L, VC2000L	W107418661	21,99 €
adaptér ku stroju	pre hadicu Ø 32 mm	32/38	VC2012L, VC2512L, 3011L, VC2000L	W107418680	20,99 €

## VŔTANIE / SEKANIE

### Odsávanie

Len pre sekacie Ø hadice 28 mm na priame pripojenie



odsávanie príslušenstvo pre SDS-MAX 40 – 45 mm vŕtanie / sekacie

model	Obj. č.	MOC s DPH	
DHR400, HM001G, HM002G, HR005G, HR006G, HM0830, HM0870C, HM0871C, HM1101C, HM1111C, HM1201, HM1203C, HM1205C, HM1213C, HM1214C, HR3530, HR3540C, HR3541FC, HR4001C, HR4002, HR4003C, HR4010C, HR4011C, HR4013C, HR4030C, HR4041C, HR4501C, HR4510C, HR4511C, HR5212C, HR5202C	odsávací set bez hadice	199143-4	15,99 €
HM1304/B, HM1306, HM1307C/CB, HM1317C/CB, HM1400, HM1500/B, HM1801, HM1802, HM1810, HM1812	odsávací set s hadicou	197148-8	cena na vyziadanie
	odsávací set bez hadice	197168-2	47,99 €
HM1501, HM1502, HM1511, HM1512	odsávací set s hadicou	191M20-4	65,99 €
	odsávací set bez hadice	191M21-2	28,99 €
HR006G		191N81-0	cena na vyziadanie
HR5212C, HR5202C		196858-4	91,99 €

### Odsávacie adaptéry pre vŕtacie kladivá

Odsávacie adaptéry pre vŕtacie kladivá  
Tento systém je navrhnutý tak, aby efektívne zachytával prach pri zapnutí / vypnutí nástrojov



DHR182	DX05	199664-4	cena na vyziadanie
DHR243	DX07	199572-1	139,99 €
DHR280, DHR282	DX08	199581-0	164,99 €
HR3011F	DX10	191F95-1	115,99 €
HR3012F	DX11	191G00-4	121,99 €
HR001G, HR003G	DX12	191E54-9	166,99 €
HR002G, HR004G	DX14	191E60-4	175,99 €
HR007G	DX15	191X40-4	140,99 €
HR010G, DHR187	DX16	1911R9-6	cena na vyziadanie
HR2652, HR2653, HR2653T, HR2663		127185-8	105,99 €
DHR242, HR2650, HR2651, HR2652, HR2653, HR2661, HR2663, DHR281, DHR283, HR002G, HR004G HR3012FC, DHR243		195173-3	6,79 €
DHR242, HR2650, HR2651, HR2652, HR2653, HR2661, HR2663, DHR281, DHR283, HR002G, HR004G HR3012FC, DHR243		195179-1	8,39 €
HR140D, HR166D, DHR164, DHR165, DHR171, DHR182, DHR263, DHR264 DHR202, DHR262, HR1840, HR2020, HR2460, HR2460F, HR2470FT, HR2470T, HR2470, HR2470F, HR2475, HR2800, HR2810, HR2810T, HR2811F, HR2811FT,		193472-7	46,99 €

### HEPA filtre pre odsávacie adaptéry



DX6, DX07, DX08, DX09, DX10, DX11, DX12, DX14, DX15		199557-7	10,99 €
DX05		199596-7	8,79 €
DX16		199596-7	8,79 €
filter s oklepom pre DX05		199595-9	68,66 €
filter s oklepom pre DX10 / DX11		191F49-8	51,99 €
filter s oklepom pre DX16		1911P5-0	31,99 €

### Manžety



DX6, DX07, DX08, DX09, DX10, DX11, DX12, DX14, DX15		424474-5	0,69 €
protiprachový kryt pre stopku vŕtáka sekáča Ø 6 – 14 mm		421342-3	1,89 €
protiprachový kryt pre stopku vŕtáka sekáča Ø 10 – 18 mm		421664-1	2,09 €



# Pripojenie stroja k vysávačom \*Ien pre modely DVC261, DVC265, DVC660, DVC66

<b>Model</b> VC002GL VC004GL DVC157L DVC867L VC006GM VC007GL		<b>Model</b> VC3211H VC3211M VC2211M VC3210L VC2510L VC1310L		<b>Model</b> VC009G DVC265 DVC665 DVC350		<b>Model</b> DVC750L		<b>Model</b> VC3012L/M VC4210L/M		<b>Model</b> VC2012L VC2512L VC3011L	
--	---	--	---	--	---	-------------------------	--	--	---	---	---

<b>Hadica 28 mm</b> 1.0m *143787-2 bez koncovky hadice 1.5m A-34235 s koncovkou hadice 22, 38 2.5m 195437-5 s koncovkou hadice 22, 24, 39 3.5m 195433-3 s koncovkou hadice 22, 24, 39 5.0m 195436-7 s koncovkou hadice 22, 24, 40 5.0m A-34229 s koncovkou hadice 22, 38		<b>Hadica 38 mm</b> s adaptérom 38 1.5 198757-6 2.5 195434-1 5.0 195435-9		<b>32-B Hadica 32 mm</b> 4m P-84084		<b>32-B Hadica 32 mm</b> 3.5m P-81739	
--	---	---	---	--	---	--	---

<b>Koncovka hadice</b> Koncovka hadice 38 195545-2 Koncovka hadice 22 195547-8		<b>Koncovka hadice 24</b> 195546-0		<b>Redukcia 22 - 38</b> 195548-6		<b>Koncovka hadice 24</b> 195546-0		<b>Adaptér</b> Quicksystem ø24 (set) P-70378 Quicksystem ø38 (set) W107418688		<b>Adaptér</b>	
--	---	---------------------------------------	---	-------------------------------------	---	---------------------------------------	---	---	---	----------------	---

**Odsávacie adaptéry**



**AWS**  
Auto-start Wireless System











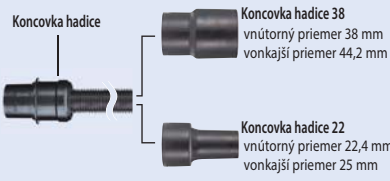



**Modul AWS Bluetooth**



**WUT02**  
Adaptér na pripojenie elektrických vysávačov s akumulátorovými strojmi



## Adaptéry, redukcie a pripojenie hadíc

<b>Hadica 28 mm</b> Dodávaná s dvomi adaptérmí 22 a 38		Koncovka hadice		<b>Koncovka hadice 38</b> vnútorný priemer 38 mm vonkajší priemer 44,2 mm	<b>Koncovka hadice 22</b> vnútorný priemer 22,4 mm vonkajší priemer 25 mm
<b>Hadica 38 mm</b>		Koncovka hadice		<b>Koncovka hadice 38</b> vnútorný priemer 38 mm vonkajší priemer 44,2 mm	
<b>Prepojenie hadice s hadicou</b> Hadica 28 s koncovkou 38		Hadica 28	Koncovka hadice		
Hadica 38 s koncovkou 38		Hadica 38	Koncovka hadice		
<b>Koncovka 22, 24, 38</b> Hadica 28 s koncovkou 22		+	Koncovkou 24		
Hadica 28 s koncovkou 38		+	Koncovkou 24		
Hadica 38 s koncovkou 38		+	Koncovkou 24		
<b>Adaptér 22 - 38</b> Hadica s koncovkou 38		+	Adaptér 22 - 38		Rozmery vnútorný priemer 22,4 mm vonkajší priemer 25 mm



### A S hadicou Ø 28 mm

Model

VC002GL / VC004GL VC3211H / VC3211M VC008G / VC009G DVC350  
 DVC157L / DVC867L VC2211M / VC3210L VC011G / VC012G  
 VC2510L / VC1310L DVC660 / DVC665  
 DVC261 / DVC265

### S koncovkou hadice



38 24 22



### B S hadicou Ø 38 mm

Model

VC001GL / VC003GL  
 VC005GL / DVC155L  
 DVC156L / DVC860L  
 DVC861L / DVC865L  
 DVC866L / DVC750L

### s adaptérom 22 - 38



### C S hadicou Ø 32 mm

Model

VC2012L / VC2512L  
 VC3011L / VC2000L

### S adaptérom

24 Adaptér 38



P-81745 P-70421



### D S hadicou Ø 32 mm

Model

VC3012M / VC3012L  
 VC4010M / VC4010L

### S adaptérom

24 38



P-70378 W107418688

## Vŕtacie a búracie kladivá

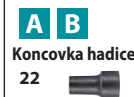
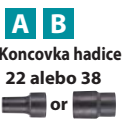

Model	Prevádzkový režim	Odsávací adaptér		Koncovka hadice / veľkosť
		Typ	Obj. č.	
Búracie kladivá	---	bez hadice	191M21-2 191M23-8**	Hadica 28 bez koncovky
		s hadicou	191M20-4 191M22-0**	Koncovka 24 alebo 38
HM1306, HM1307C/CB, HM1317C/CB, HM1802, HM1812	---	bez hadice	197168-2 197170-5**	Hadica 28 bez koncovky
		s hadicou	197148-8 197172-1**	Koncovka 24 alebo 38
Sekacie kladivá	---	bez hadice	199143-4 199017-9**	Hadica 28 bez koncovky
		s hadicou	199142-6 199014-5**	Koncovka 24 alebo 38
Kombinované kladivá	DHR400, HR005G HR4013C, HR4003C	Sekanie / vŕtanie	197148-8 197172-1**	Koncovka 22
	HR5212C, HR5202C	Sekanie / vŕtanie	196858-4	Koncovka 22
	HR006G	Sekanie / vŕtanie	191N81-0 191N82-8**	Koncovka 22
	HR4002, HR4501C, HR4510C, HR4511C,	Sekanie / vŕtanie	196074-8	Hadica 28 bez koncovky
	HR5212C, HR5202C, HR4002, HR4501C, HR4510C, HR4511C, HR4041C, HR4030C, HR4013C, HR4003C HR3541C, DHR400, HR005G, HR006G	Sekanie	s hadicou bez hadice	199144-2 199019-5** 199143-4 199017-9**

Model	Prevádzkový režim	Odsávací adaptér		Koncovka hadice / veľkosť
		Typ	Obj. č.	
HR140D, HR166D, DHR164, DHR165, DHR171, DHR182, DHR202, DHR262, DHR263, DHR264, HR1840, HR2230, HR2470, HR2470F, HR2470FT, HR2470T, HR2475, HR2800, HR2810, HR2810T, HR2811F, HR2811FT,	Vŕtanie	Odsávací adaptér	193472-7	Koncovka 22
*DHR164, *DHR165, *HR166D, *DHR171, *DHR182, *DHR202, *DHR241, *DHR262, DHR263, *HR1840, *HR1841F, *HR2230, HR2470, HR2470F, HR2475, HR2800, HR2810, HR2811F	Sekanie / vŕtanie	Zberný adaptér	198362-9 198376-8 (EU)	Koncovka 22
DHR242, DHR280, DHR282, HR001G, HR003G, HR2300, HR2600, HR2601, HR2601F, HR2630, HR2631F, HR2641, HR2651, HR2652, HR2653, HR2663, HR3001C, HR3011F, HR007G	Sekanie / vŕtanie	Odsávací adaptér	195173-3	Koncovka 22
DHR243, DHR281, DHR283, HR002G, HR004G, HR2320T, HR2630T, HR2631FT, HR2653T, HR3012F	Sekanie / vŕtanie	Odsávací adaptér	195179-1	Koncovka 22
DHR183, HR010G	Vŕtanie	Odsávací adaptér	1911P8-4	Koncovka 22
HR010G	Sekanie / vŕtanie	Zberný adaptér	**413N62-7	Koncovka 22

## Kotúčové píly a ponorné píly

\*potrebná aj vnútorná príruka



\* nie je potrebná koncovka hadice 24



Model	Adaptér		Koncovka
	Popis	Obj. č.	
DHS630	Odsávací adaptér	194314-8	22
DHS631	Odsávací adaptér	196995-4	22
DHS660, DHS661	Odsávací adaptér	199230-9	24
DHS680, HS012G	Odsávací adaptér	196961-1	24
DHS710	Odsávací adaptér	196520-1	24
DHS711	Odsávací adaptér	196843-7	24
DHS780, DHS781, DHS782, DHS783	Odsávací adaptér	196520-1	24
HS009G, HS010G, HS011G	---	---	24
DHS900, DHS901, DSP600, DSP601	---	---	24
DSS501	Odsávací adaptér	194415-2	22
DSS611	Odsávací adaptér	199460-2	22
RS001G	---	---	24
RS002G, 5017RKB	---	---	38
5007F, 5007FA, 5007NB	Odsávací adaptér	199711-3	24
5007MGA, 5007MG	Odsávací adaptér	199716-3	24
5007N, 5007NF	Odsávací adaptér	199712-1	24
5008MG, 5008MGA	Odsávací adaptér	194489-3	38
5103R	Adaptér s 2 x skrútkou	415426-7/192419-8	38
5104, 5104S	Adaptér	199427-0	38
5143R	Adaptér	192490-2	38
N5900B, 5902B	Adaptér	193068-4/193823-4	38
5903R	Adaptér	192419-8	38
HS003G, HS004G	Odsávací adaptér	196520-1	24
HS301D	Odsávací adaptér	195334-5	22
HS0600	Odsávací adaptér	198263-1 / 198265-7	24
HS6100, HS6101	Odsávací adaptér	195801-0	24
HS6600	Odsávací adaptér	196843-7 / 196520-1	24
HS6601	Odsávací adaptér	196520-1	24
HS7000	Odsávací adaptér	197221-4 / 196520-1	24
HS7010	Odsávací adaptér	196520-1	24
HS7100, HS7101	Odsávací adaptér	195801-0	24
HS7600	Odsávací adaptér	197221-4 / 196520-1	24
HS7010, HS7610, HS7611	Odsávací adaptér	198933-2	24
HS7601, HS7610, HS7611	Odsávací adaptér	196520-1	24
SP6000, SP001G	---	---	24

## Uhlové brúsky

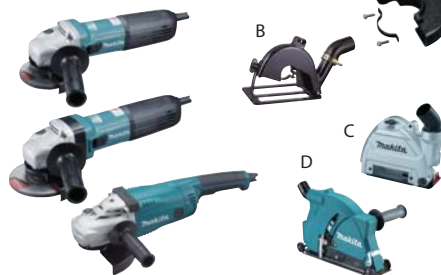

Model	Kryt kotúča na zachytávanie prachu		Koncovka
	Typ krytu kotúča	Obj. č.	
pre uhl. brúsky 115/125 mm	C	196845-3	38
125 mm modely X-Lock	C	191G05-4	38
pre uhl. brúsky 115/125 mm, bez nástrojová výmena	C	191G06-2	38
pre uhl. brúsky 180/230 mm	D	198379-2(M14 spindle) 198440-5(EU) 198509-5 (5/8" spindle) 198510-0 (M16 spindle)	38
pre uhl. brúsky 180/230 mm	B	194044-1	38

## Uhlové brúsky / diamantové brúsenie



Model	Kryt kotúča pre diamantové brúsenie		Koncovka
	Priemer kotúča	Obj. č.	
125 mm modely X-Lock	125mm	191F81-2	38
pre uhl.brúsky 115/125 mm	125mm	127147-6	38
pre uhl.brúsky 180/230 mm použitie len 180 mm brúsný kotúč	180mm	195385-8	38

Model	Systém prepojenie s vysávačom
<b>Pásová brúska</b> DBS180, 9032	<b>Adaptér</b> 122652-8
<b>Pásová brúska</b> 9031	
<b>Vibračné brúsky</b> DBO380, DBO381, DBO480, DBO481, DBO482 9046, BO3700, BO3710, BO3711, BO4900/V, BO4901 BO4555, BO4556, BO4565, BO4566, BO4557, BO4558	
<b>Excentrické brúsky</b> BO5012, BO5030, BO5031, BO5040, BO5041, BO6030, BO6040, DBO180	
<b>Multi Tool</b> DTM52 DTM51 DTM50 TM3000C TM3010C	<b>Odsávacie adaptéry</b> 191R02-6 199627-2 199621-4 199618-3 199624-8
<b>Pásová brúska</b> 9404, 9902, 9903, 9910, 9911, 9920,	
<b>Excentrická brúska</b> BO6050	<b>Koncovka hadice 24</b> 195546-0
<b>Brúska na sádkartón</b> DSL800, DSL801	<b>Koncovka hadice 24</b> 195546-0
	<b>A</b>  <b>Koncovka 22</b>
	<b>B</b>  <b>Koncovka 22</b>
	<b>C</b>  <b>Koncovka 22</b>
	<b>D</b>  <b>Adaptér 22-38</b> 195548-6
	<b>E</b>  <b>Koncovka 22</b>
	<b>F</b>  <b>Adaptér 24</b> + <b>Adaptér 25-50</b> 192349-3 <b>alebo</b> <b>Adaptér 24*</b>
	<b>G</b>  <b>Adaptér 38</b> + <b>Adaptér 22-38</b> 195548-6 <b>alebo</b> <b>Adaptér 24*</b>

\*Nie je potrebný pri koncovke hadice 24















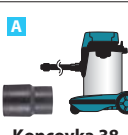





Model	Systém prepojenie s vysávačom
<b>Priamočiare píly</b> JV100D, JV143D JV183D, 4326, 4327, 4328, 4329 JV0600	
<b>Priamočiare píly</b> DJV180, 4350T/CT/FCT, 4351T/CT/FCT	<b>Odsávací adaptér</b> 417853-4
<b>Akumulátorové priamočiare píly</b> DJV181, DJV182 **JV102D, JV103D	<b>Odsávací adaptér</b> 126331-0 457801-1
<b>Pila na kov</b> DCS553	<b>Koncovka 24</b> 195546-0
	<b>Kryt komplet</b>
	<b>A</b>  <b>Koncovka 22</b>
	<b>B</b>  <b>Koncovka 22</b>
	<b>C</b>  <b>Koncovka 22</b>
	<b>D</b>  <b>Adaptér 22-38</b> 195548-6
	<b>E</b>  <b>Koncovka 22</b>
	<b>F</b>  <b>Adaptér 24</b> + <b>Adaptér 25-50</b> 192349-3 <b>alebo</b> <b>Adaptér 24*</b>
	<b>G</b>  <b>Adaptér 38</b> + <b>Adaptér 22-38</b> 195548-6 <b>alebo</b> <b>Adaptér 24*</b>







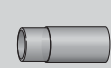













\*\*Použitie s krytom 458191-5









\*Nie je potrebný pri koncovke hadice 24



Model	Systém prepojenie s vysávačom
<b>Uhlová rezačka</b> 4112H, 4112HS, 4114, 4114S 	<b>Zahnutý adaptér 32</b> 192613-2 
<b>Diamantová rezačka</b> 4100KB <b>Akumulátorová diamantová rezačka</b> DCC500 <b>Píla so zberným zásobníkom</b> 4157KB  	 <b>A</b> <b>Koncovka 38</b>  <b>B</b> <b>Koncovka 38</b>  <b>C</b> <b>Koncovka 38</b>  <b>D</b>
<b>Drážkovacie frézy</b> SG1251, SG1250 	 <b>E</b> <b>Koncovka 38</b>  <b>E</b>
<b>Leštička</b> PC5000C, PC5001C, PC5010C 	 <b>G</b> <b>Adaptér 38</b>
<b>Pásová brúska</b> 9924DB <b>Adaptér 32</b> 192518-6  	 <b>E</b> <b>Koncovka 38</b>
<b>Pásová brúska</b> 9403, 9921 	<b>Adaptér 32</b> 192349-3 
<b>Keľová brúska</b> 9741 	<b>Adaptér</b> 410899-9 



Model	Systém prepojenie s vysávačom
<b>Akumulátorové pokosové píly</b> DLS713, DLS714 	<b>A</b> <b>Koncovka 38</b>  <b>B</b> <b>Koncovka 38</b>  <b>C</b> <b>Koncovka 38</b>  <b>D</b>  <b>E</b>  <b>E</b> <b>Koncovka 38</b>  <b>G</b> <b>Adaptér 38</b> 
<b>Pokosové píly</b> LS0714/F/FL/L, LS0815F/FL, LS1016L, LS1017L, LS1018/L, LS1216/L 	 <b>E</b> <b>Koncovka 38</b>
<b>Pokosové píly</b> LS1030N, LS1440 	 <b>E</b> <b>Koncovka 38</b>
<b>Pokosové píly</b> LS1040/F, LS1045, LS1221 	 <b>E</b> <b>Koncovka 38</b>
<b>Akumulátorové pokosové píly</b> DLS600 	 <b>E</b> <b>Koncovka 38</b>
<b>Stolové pokosové píly</b> LH1040/F, LH1201FL 	 <b>G</b> <b>Adaptér 38</b>
<b>Pokosové píly</b> LS1019/L, LS1219/L <b>Koncovka hadice</b> 195546-0  	 <b>G</b> <b>Adaptér 38</b>
<b>Akumulátorové pokosové píly</b> LS002G, LS003G, LS004G, DLS110, DLS111, DLS112, DLS211, DLS212 	 <b>G</b> <b>Adaptér 38</b>



Model	System prepojenie s vysavačom
<b>Stolová píla</b> 2704N, 2705 	<b>Adaptér</b> 419093-0 
<b>Stolová píla</b> 2703 	<b>Adaptér 55</b> 192799-2 
<b>Stolová píla</b> MLT100N 	<b>Adaptér</b> JM27000090 
<b>Stolová píla</b> 2712 	
<b>Pásová píla</b> LB1200F 	<b>Adaptér</b> 419093-0 



<b>Hoblovačka</b> 2012NB 	<b>Odsávací adaptér</b> 193036-7 Vonkajší priemer 76 mm 
--	--

Pre odsávacie hadice s vnútorným priemerom 76 mm



Model	System prepojenie s vysavačom
<b>Hoblíky</b> KP001G, DKP181, KP0810/C 	<b>A Koncovka 38</b> 
<b>Hoblíky</b> DKP180, KP0800 	<b>Adaptér</b> 451329-1 
<b>Hoblíky</b> 1805N 	<b>Adaptér</b> JPA122277 
<b>Hoblíky</b> 1100 	<b>Adaptér</b> 415452-6 
<b>Hoblíky</b> 1911B 	<b>Adaptér</b> 192082-7 
<b>Hoblíky</b> N1900B, N1923B, KP0800, 1804N, 1805N, 1806B, KP312/S 	<b>Adaptér 38</b> 
	<b>Adaptér 38</b> 

\*C: DVC350 nie je možné použiť s hoblíkmi

### Odsávací adaptér









### Adaptér \*Zahnutý



Model	Obj. č.	Model	Obj. č.
N1900B	191569-6	N1900B, N1923B	192799-2 JPA122275
N1923B	152464-5		
KP0800, DKP180, DKP140	451329-1		
1804N	JPA122278 (122278-6)	DKP180, DKP181, KP0810/ C, KP0800	*191C20-4
1805N	JPA122277 (122277-8)		
1806B	414499-7	1804N, 1805N, 1806B, KP312/S	181575-9
KP312/S	193733-5		

Model	Systém prepojenie s vysávačom
<b>Lamelovacia fréza</b> PJ7000, DPJ180	 <b>Koncovka 22</b>
<b>Jednoručná fréza</b> 3706	 <b>Koncovka 22</b>
<b>Odsávací adaptér</b> 193449-2	 <b>Koncovka 22</b>
<b>Akumulátorová ručná fréza</b> DCO181, DCO180	 <b>Adaptér 22-38</b> 195548-6
<b>Akumulátorová píla na sádkokartón</b> DSD180, SD100D	 <b>Koncovka 22</b>
<b>Horné frézy</b> RP1111C, RP1110C, RP0910	 <b>Adaptér 24 + Adaptér 25-50</b> 192349-3
	 <b>Adaptér 38 + Adaptér 22-38</b> 195548-6

\*C: DVC350 nie je možné použiť s frézami

Model	Systém prepojenie s vysávačom
<b>Horné frézy</b> RP1802/ F, RP1803/ F, RP1801/ F, RP1800/ F, RP2302FC, RP2303FC, RP2301FC, RP2300FC	<b>Odsávací adaptér</b> 194934-8
 <b>Koncovka 38</b>	
3612BR	<b>Odsávací adaptér</b> 192035-6
	 <b>Koncovka 38</b>
<b>Horné frézy</b> RD1101, RF1101, RP1101	<b>Odsávací adaptér</b> 193379-7
	 <b>Koncovka 38</b>
<b>Horné frézy</b> RP0900, ***RT0700C, ***RT0702C	<b>Odsávací adaptér</b> 194733-8
<b>Akumulátorové horné frézy</b> ***RT001G, ***DRT50	
*** len so použitím ponornej základne	 <b>Koncovka 38</b>
<b>Horná fréza</b> RT0700C	<b>Odsávací adaptér</b> 195559-1
	 <b>Koncovka 38</b>
<b>Akumulátorové horné frézy</b> RT001G, DRT50	
	 <b>Adaptér 38</b>



Spoločnosť Makita odporúča použiť hadicu s priemerom 38 mm pri frézach



## Príslušenstvo pre modely HG6031, HG6030, HG5030, HG6530, HG6531

popis	Obj. č.	MOC s DPH	
	dýza chrániaca sklo pred poškodením	PR00000028	7,29 €
	dýzy plochá	PR00000029	6,59 €
	dýzy odrazová	PR00000030	8,29 €
	dýzy pre zváranie preplátovaním	PR00000032	14,99 €
	dýza pájkovacia odrazová	PR00000033	17,99 €
	dýza zvracia	PR00000034	6,59 €
	valček prítlačný	PR00000035	11,99 €
	tavné tyčinky ABS použitie v automobilovom priemysle	PR00000036	11,99 €
	tavné tyčinky HDPE polyetylén s vysokou hustotou	PR00000037	9,99 €
	tavné tyčinky PP pre materiály z polypropylénu tavná teplota 250-310°	PR00000038	9,19 €
	dýza pre rýchle zváranie, použitie len s dýzou	PR00000039	8,29 €
	škrabka plochá	PR00000040	15,99 €
	škrabka sada 4 ks	PR00000041	10,99 €
	škrabka	PR00000042	7,19 €



model	výška	popis	upevňovacia skrutka	Obj. č.	MOC s DPH	
	DML805	992 – 1 750 mm	stožan lampy, možnosť pripevniť dve lampy	M8	GM00002283	86,99 €
	ML009G, ML003G, ML005G, DML809, DML811	1.300 - 2.000 mm	stožan lampy, možnosť pripevniť jednu lampu	M10	GM00002378	212,99 €
	DML809, DML811, ML003	1 300 – 2 000 mm	stožan lampy, možnosť pripevniť dve lampy	M10	GM00002073	236,99 €
	ML105, ML104		magnet		GM00001683	20,99 €
	DML809		difúzor svetla		GM00002286	23,99 €
	DML811		difúzor svetla		GM00002287	15,99 €
	ML005G		difúzor svetla		GM00002358	14,99 €
	ML009G		difúzor svetla		GM00002377	22,99 €
	ML009G		Anti reflexná fólia		GM00002376	13,99 €
	ML005G		Anti reflexná fólia		GM00002359	8,39 €

popis	Obj. č.	MOC s DPH
-------	---------	-----------

### Príslušenstvo k Akku kávovaru DCM501



hrnček	KF00000020	14,99 €
viečko hrnčeka	KF00000069	2,36 €
dávkovač kávy	KF00000033	1,50 €

Akumulátory  
Odkláďacie systémy  
Vŕtanie  
Skrutkovanie  
Brúsky  
Pílenie  
Frézovanie  
Brúsenie  
Klince / spony  
Špeciálne stroje  
Vysávanie  
Fény/lampy  
Záhrada  
Ručné náradie  
Ostatné

## PRÍSLUŠENSTVO PRE ZÁCHRANNÉ ZLOŽKY

### Diamantové rezné kotúče

Vákuovo zvárané diamantové rezné kotúče špeciálne určené pre záchranné zložky, ideálne pre záchranné a vyslobodzovacie práce. (rezanie autokarosérií, stavebné materiály a pod.)  
Vhodné na kov, drevo, PVC, sklo, tehly a mnohé ďalšie.

Ø mm	Vrtanie (mm)	Hrúbka kotúča (mm)	Max. voľnobežné otáčky (min <sup>-1</sup> )	Ks / bal.	Obj.č.
125	22,23	2,8	12.250	1	B-55310
125	X-LOCK	2,8	12.250	1	E-19738
230	22,23	3,1	6.650	1	B-55326
350	25,4	3,4	5.500	1	B-55348



Diamantové kotúče uvedené na tejto strane sú len na objednávku.

### Pílové listy pre chvostové píly

Odolné TC hroty privarené na okrajoch zubov pílového listu, určené pre zachranné zložky. Ideálne pre záchranné a vyslobodzovacie práce (rezanie autokarosérií, stavebné materiály a pod.)  
Vhodné na kov, drevo, PVC, sklo, tehly a mnohé ďalšie.

Celková dĺžka (mm)	Pracovná dĺžka (mm)	Hrúbka listu (mm)	Materiál listu	TPI	Typ zubu	Ks / bal.	Obj. č.
225	207	1,25	TC / HM	6-8	Frézované vlnité vsadené zuby	25	B-67212
152	130	1,25	TC / HM	6-8	Frézované vlnité vsadené zuby	25	B-67206



Pílové listy uvedené na tejto strane sú len na objednávku.



# PRÍSLUŠENSTVO

▣ Príslušenstvo pre záhradu



# PRÍSLUŠENSTVO PRE ZÁHRADU

## Matice nožov, podložky, misky



\*\*\* podložka s ochranou proti namotaniu trávy

### Akumulátorový krovinořez

Model	Veľkosť vretena / tvar		Podložka			Blade clamp washer			Blade cup			Blade nut
			Vŕtanie noža (mm)	Priemer (mm)	Obj. č.	Priemer (mm)	Vŕtanie noža (mm)	Obj. č.	Priemer (mm)	Vŕtanie noža (mm)	Obj. č.	Obj. č.
DUR184, DUR190L/U, DUR191L/U	M10x1,25LH	Oválny otvor	25,4	---	***140T23-7	50	Oválny otvor 12-10	347668-4	68	10,2	168526-9	264025-0
DUR365U, DUR366L, UR006G, UR007G	M10x1,25LH	Spline 10T	25,4	42	326518-6	50	10,2	346084-7	68	10,2	168526-9	264025-0
				---	***140L84-9							
DUR368A/L, UR002G, UR003G	M10x1,25LH	Spline 10T	25,4	---	***140L84-9	50	10,2	346084-7	68	10,2	168526-9	264025-0
DUR369A, DUR369L, UR101C, UR201C	M10x1,25LH	Spline 10T	25,4	64,5	144312-2	43	Spline 10T	347104-0	68	12	457274-8	252236-9
UR013G	M10x1,25LH	Spline 10T	25,4	64,5	140N88-3	43	Spline 10T	347766-4	68	12	413201-5	252236-9
UR016G, UR017G	M10x1,25LH	Spline 10T	25,4	50	140A87-7	43	Spline 10T	347766-4	68	12	413201-5	252236-9
UR012G	M10x1,25LH	Spline 10T	25,4	70,5	140J59-6	54,5	Spline 10T	162567-7	Integrované s podložkou na upínanie noža			252236-9

### Nadstavce pre delené krovinořezy

Model	Veľkosť vretena / tvar		Podložka			Upínacia podložka noža			Miska noža			Matica noža
			Vŕtanie noža (mm)	Priemer (mm)	Obj. č.	Priemer (mm)	Vŕtanie noža (mm)	Obj. č.	Priemer (mm)	Vŕtanie noža (mm)	Obj. č.	Obj. č.
EM400MP, EM402MP	M10x1,25LH	Ozubené 10Z	25,4	60	326821-5	50	10,2	346084-7	68	10,2	168526-9	264025-0
EM401MP	M10x1,25LH	Ozubené 10Z	25,4	60	331861-0 326821-5	50	10,2	346084-7	68	10,2	168526-9	264025-0
Old EM403MP, EM404MP	M10x1,25LH	Ozubené 10Z	25,4	64,5	144312-2	43	10	347105-8	68	10	457290-0	252236-9
New EM403MP, EM404MP	M10x1,25LH	Ozubené 10Z	25,4	64,5	144312-2	43	Spline 10T	347104-0	68	12	457274-8	
EM405MP, EM406MP	M10x1,25LH	Ozubené 10Z	-	64,5	144312-2	-	-	-	-	-	-	252236-9
EM408MP	M10x1,25LH	Ozubené 10Z	25,4	64,5	140N88-3	43	Spline 10T	347766-4	68	12	413201-5	252236-9
EM409MP	M10x1,25LH	Ozubené 10Z	-	64,5	140N88-3	-	-	-	-	-	-	252236-9













### Nadstavec orezávač trávnik

Model	Veľkosť vretena / tvar		Podložka			Upínacia podložka noža		Matica noža
			Vŕtanie noža (mm)	Priemer (mm)	Obj. č.	Priemer (mm)	Obj. č.	Obj. č.
EE400MP	M10x1,25LH	Ozubené 10Z	25,4	54	326734-0	47	326381-7	264025-0

### Akumulátorový vyžičač

Model	Veľkosť vretena / tvar		Podložka		Podložka s ochranou proti namotaniu trávy	Matica noža
			Priemer (mm)	Obj. č.		
DUR184L	M8x1,25RH	Ozubené 6Z	36,5	326683-1	346857-8	-
DUR187L/U, DUR188L/U	M8x1,25LH	Oválny otvor	36,5	144512-4	346857-8	-
DUR189	M8x1,25RH	Oválny otvor	36,5	144512-4	346857-8	-
DUR192L	M10x1,25LH	-	71	140W47-1	-	-
DUR364L	M8x1,25RH	Oválny otvor	44	319245-2	346857-8	-
DUR366L	M10x1,25LH	Ozubené 10Z	42	326518-6	346622-5	-
DUR369N, UR202C	M10x1,25LH	Ozubené 10Z	65	140N88-3	-	-
UR014G	M10x1,25LH	Ozubené 10Z	65	327B76-7	-	252236-9

## Odporúčané použitie





Typ				
		Malá a riedka tráva	Vysoká a hustá tráva	Zarastené porasty s drevnými kríkmi
Nylónová hlava		←————→		
Plastový nôž		←————→		
Kovový nôž		←————→		
		←————→		
		←————→		
Žací nôž		←————→		
Mulčovací nôž		←————→		
Píllový kotúč		←————→		
Žací nôž		←————→		
T.C.T pílový kotúč		←————→		



# PRÍSLUŠENSTVO PRE ZÁHRADU

## Nože pre krovinořezy

Vrtanie nožov: 25,4 mm





	Priemer / počet zubov	Vrtanie noža	Hrúbka noža	Vhodné pre modely	Obj. č.	MOC s DPH
	230 mm / 2	25,4 mm	2,0 mm	DUR369A, DUR369L, UR006G, UR007G, UR101C, UR201C, EM400MP, EM401MP, EM402MP, EM403MP, EM404MP, UR016G, UR017G	*197808-2	9,99 €
	305 mm / 2	25,4 mm	2,0 mm	UR012G	195624-6	cena na vyžiadanie
	230 mm / 4	25,4 mm	1,8 mm	DUR368A, DUR368L, DUR369A, DUR369L, UR002G, UR003G, UR006G, UR007G, UR016G, UR017G, UR101C, UR201C, EM400MP, EM401MP, EM402MP, EM403MP, EM404MP	**D-66008	7,29 €
	255 mm / 4	25,4 mm	2,0 mm	DUR369A, DUR369L, EM3400U/L, UR006G, UR007G, UR016G, UR017G, UR101C, UR201C	729023-6	14,99 €
	200 mm / 8	25,4 mm	1,4 mm	DUR194	191Y44-2	8,39 €
	230 mm / 8	25,4 mm	2 mm	MS20; MS26; MS27; MS4200UE; MS245,4; MS246,4; MS335,4; MS252, DUR369A, DUR369L, UR006G, UR007G, UR101C, UR201C, EM400MP, EM401MP, EM402MP, EM403MP, EM404MP, UR016G, UR017G	362224180	12,99 €
	255 mm / 3	25,4 mm	3,0 mm	UR006G, UR007G, UR101C, UR201C	385224340	16,99 €
	305 mm / 3	25,4 mm	3,0 mm	UR012G	385224150	19,99 €

## Špeciálne nože ochranné kryty





Na hustú trávu, tenké drevené výhonky. Nie je k dispozícii v niektorých krajinách kvôli miestnym predpisom

Vhodné pre model	Nôž						Ochranný kryt				
	Priemer		Vrtanie noža	Hrúbka noža	Obj. č.	MOC s DPH		Popis	Priemer rúry	Obj. č.	MOC s DPH
UR012G UR013G	225 mm		25,4 mm	1,8 mm	199872-9	18,99 €		Bez ochrannej svorky	28 mm	199873-7	20,99 €
MS4010; MS4011; MS4510; MS4511	200 mm		20,0 mm	1,6 mm	385224171	20,99 €		Komplet		010341030	24,38 €
MS3310; MS4010; MS4011; MS4510; MS4511	255 mm		20,0 mm	1,8 mm	385224161	23,99 €					

## Mulčovací nôž

Vhodné pre model	Nôž						Ochranný kryt				
	Priemer		Vrtanie noža	Hrúbka noža	Obj. č.	MOC s DPH		Popis	Priemer rúry	Obj. č.	MOC s DPH
UR012G UR013G	270mm		25,4mm	3,9mm	199874-5	29,99 €		Bez ochrannej svorky	28mm	199875-3	30,22 €

## Rotačné nožnice

Vhodné pre model	Nôž				Ochranný kryt						
	Priemer		Obj. č.	MOC s DPH		Popis	Priemer rúry	Obj. č.	MOC s DPH		
EM407MP	230mm		A : SY00146013 B : SY00146014	32,81 € 29,81 €		Bez ochrannej svorky	24mm	412999-1	9,09 €		

## Orezávač trávnik



Priemer / počet zubov	Hrúbka noža	Model	Obj.č	MOC s DPH
203 mm / 2	2,5 mm	EE400MP	196745-7	23,99 €

## Nylónové žacie hlavy

### Žacie hlavy s rýchlim navíjaním lanka

(UN-74L, UN-72L, 96-M8L/R, 96-M10L, 121-M10L)

Žacie lanko sa navíja bez rozobratia žacej hlavy

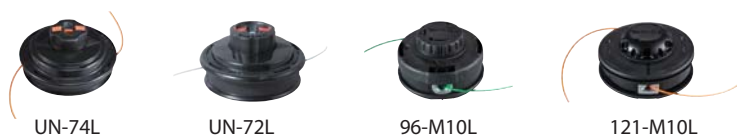

0 85(sec.)



Bežná žacia hlava

1. Demontujte kryt žacej hlavy 2. Navíňte žacie lanko na cievku 3. Vložte cievku do žacej hlavy 4. Skompletujte zatlačením žaciu hlavu 5. Hotovo

0 35(sec.)



Žacia hlava s rýchlim navíjaním lanka (napr. 96-M10L)

1. Zarovnajtie trojuholníky 2. Zasunúť žacie lanko 3. Navíňte lanko pomocou otáčania krytky 4. Hotovo

Až o 58 % kratší čas doplnenia!

## Nylónové žacie hlavy

\* s adaptérom



Očko 2ks/sada pre Push & Go 4L/4R/Z5L, Ultra Auto 4R/4L/6L obj. č. A-15992

Popis	Typ hlavy	Veľkosť	Závit vretena	Vhodné pre modely	Veľkosť lanka	Typ lanka	Obj. č.	MOC s DPH
<b>Žacia hlava s rýchlim navíjaním lanka Push &amp; Go</b> 	96-M8R	4"	M8x1.25RH	DUR189	2.0mm x 4m	štvorlístok	191D92-5	19,99 €
	96-M8L	4"	M8x1.25LH	DUR187L	2.0mm x 4m	štvorlístok	191D91-7	12,99 €
	96-M10L	4"	M10x1.25LH	DUR190L, DUR190U, DUR191L, DUR191U, DUR192L, DUR368A, DUR368L, DUR369A, DUR369L, DUR369N, UR002G, UR003G, UR006G, UR007G, UR101C, UR201C, UR202C, UR016G, UR017G, EM400MP, EM401MP, EM403MP, EM404MP, EM405MP, EM406MP, EM408MP, EM409MP	2.4mm x 3m	štvorlístok	191D90-9	12,99 €
	121-M10L	5"	M10x1.25LH	UR012G	2.4mm x 4m	štvorlístok	191D93-3	17,99 €
	121-M10L	5"	M10x1.25LH	UR013G	2.7mm x 2m	štvorlístok	1911Y2-9	14,99 €
<b>Push &amp; Go</b> 	76-M8R	3"	M8x1.25RH	UR100D	1.65mm x 8m	štvorlístok	198854-8	22,99 €
	95-M8R	4"	M8x1.25RH	DUR189	2.0mm x 3m	štvorlístok	198971-4	11,99 €
	95-M8L	4"	M8x1.25LH	DUR187U/L, DUR188U/L, EM2500U/L, EM2600U/L	2.0mm x 3m	štvorlístok	198385-7	14,99 €
	95-M10L	4"	M10x1.25LH	DUR190L, DUR190U, DUR191L, DUR191U, DUR192L, DUR365U, DUR366L, DUR368A, DUR368L, DUR369A, DUR369L, DUR369N, UR002G, UR003G, UR006G, UR007G, UR101C, UR201C, UR202C, UR016G, UR017G, EM400MP, EM401MP, EM403MP, EM404MP, EM405MP, EM406MP, EM408MP, EM409MP	2.0mm x 3m 2.4mm x 3m	štvorlístok	198893-8 123556-7	12,99 € 10,26 €
<b>Push &amp; Go</b> 	Bump & Feed ECO 4L	4" Low profile	M10x1.25LH	DUR192L, DUR368A, DUR368L, DUR369A, DUR369L, DUR369N, UR002G, UR003G, UR006G, UR007G, UR101C, UR201C, UR202C, UR016G, UR017G, EM408MP, EM409MP	2.0mm x 3m	štvorlístok	197296-3	15,99 €
	Automatické podávanie a Push & Go	Ultra Auto 4L	4"	M8&10x1.25LH	DUR187U/L, DUR188U/L, EM400MP, EM401MP, EM403MP, EM404MP, EM405MP, EM406MP	2.4mm x 3m	okružlé	*B-02945











Lanko vysúva približne o 3 cm na obidve strany  
 – rotácia hlavy dosiahne otáčky 8 500 min<sup>-1</sup>  
 – klepnúť hlavu o zem keď je v otáčkach, lanko sa automaticky vysunie

# PRÍSLUŠENSTVO PRE ZÁHRADU





## Rada nylónov

Tvar	Ostrosť hrany	Úspora	Hľučnosť
		A	A
	AA		
	A	AA	AA

## Farebné rozlíšenie

Priemer	Farba / tvar	Ľahká práca		Ťažká práca	
		Riedka tráva	Hustá tráva	Riedka tráva	Hustá tráva
1.3mm		↔			
1.6mm - 1.65mm	 	↔↔			
2.0mm	 		↔↔↔		
2.4mm	  		↔↔↔↔		
2.7mm				↔↔↔↔↔	
3.0mm	 				↔↔↔↔↔↔





## Štandardné nylónové lanko

Farba / tvar		Priemer (mm)	Dĺžka (m)	Obj. č.	MOC s DPH	MOC za 1 m s DPH
	Single	1.3	15	E-02727	1,69 €	0,11 €
	Single	1.6	15	E-02733	1,89 €	0,13 €
	Single	2.0	15	E-02705	1,89 €	0,13 €
	Single	2.0	126	E-02711	8,99 €	0,71 €
	Single	2.4	15	E-02749	2,69 €	0,18 €
	Single	2.4	87	E-02761	9,69 €	0,11 €
	Single	2.4	262	E-02783	24,99 €	0,10 €
	Single	3.0	15	369224809	3,09 €	0,21 €
	Single	3.0	56	369224811	9,09 €	0,16 €
	Single	3.0	168	369224815	24,99 €	0,15 €
	Single	3.3	15	369224810	3,39 €	0,23 €
	Single	3.3	46	369224812	9,39 €	0,20 €
	Single	2.4	15	E-02808	2,69 €	0,18 €
	Single	2.4	69	E-02814	8,99 €	0,33 €
	Single	2.4	206	E-02820	24,99 €	0,12 €
	Single	3.0	15	369224819	3,79 €	0,25 €
	Single	3.0	44	369224821	9,09 €	0,21 €
	Single	3.0	132	369224825	24,99 €	0,19 €
	Single	4.0	25	369224824	9,09 €	0,36 €

## Nylónové lanko štvorhran točeny

Farba / tvar		Priemer (mm)	Dĺžka (m)	Obj. č.	MOC s DPH	MOC za 1 m s DPH
	Single	2.0	15	369224060	3,79 €	0,25 €
	Single	2.0	120	369224062	19,99 €	0,17 €
	Single	2.4	120	369224072	22,99 €	0,19 €
	Single	2.7	90	369224063	22,99 €	0,26 €
	Single	2.7	15	369224673	5,29 €	0,35 €
	Single	3.0	15	369224674	5,79 €	0,39 €



## Nylónové lanko v tvare štvorlístka

Farba / tvar		Priemer (mm)	Dĺžka (m)	Obj. č.	MOC s DPH	MOC za 1 m s DPH
	Single	1.65	15	E-01731	2,19 €	0,15 €
	Single	1.65	30	E-01747	4,09 €	0,14 €
	Single	1.65	445	E-01753	29,99 €	0,07 €
	Single	2.0	15	E-01769	2,49 €	0,17 €
	Single	2.0	30	E-01775	4,59 €	0,15 €
	Single	2.0	310	E-01781	29,99 €	0,10 €
	Single	2.4	15	E-01797	2,99 €	0,20 €
	Single	2.4	30	E-01806	5,59 €	0,19 €
	Single	2.4	225	E-01812	29,99 €	0,13 €
	Single	2.7	15	E-01828	3,09 €	0,21 €
	Single	2.7	30	E-01834	6,19 €	0,21 €
	Single	2.7	180	E-01840	29,99 €	0,17 €



## Dvojité nylónové lanko

Increased durability up to 130%\* thanks to Flexible core coated with Impact & abrasion resistant skin  
\*compared to standard nylon cord



Farba / tvar		Priemer (mm)	Dĺžka (m)	Obj. č.	MOC s DPH	MOC za 1 m s DPH
	Single	3.0	15	E-02836	3,79 €	0,25 €
	Single	3.0	56	E-02842	11,99 €	0,21 €
	Single	3.0	168	E-02858	27,99 €	0,17 €
	Single	3.0	279	E-02864	44,99 €	0,16 €
	Single	3.0	15	E-02870	3,99 €	0,27 €
	Single	3.0	44	E-02886	10,99 €	0,25 €
	Single	3.0	132	E-02892	27,99 €	0,21 €
	Single	3.0	219	E-02901	44,99 €	0,21 €

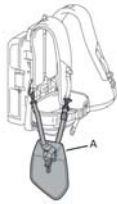

Popruhy			model	vhodný pre model	Obj. č.	MOC s DPH				
 <p><b>Popruh pre PDC01 a PDC1200</b></p>	Model	Obj. č.	MOC bez DPH		DUA250, DUA251, DUA300, DUA301, DUN500W, DUN501W, DUR181, DUR184L, DUR187L, DUR188L, DUR189, DUR190L, DUR191L, DUR192L, DUR194, DUR368A, DUR368L, DUR369A, DUR369L, UA001G, UA002G, UA003G, UA004G; UR100D, DUX60	125516-5	2,49 €			
	A	191E43-4	17,99 €							
	Jednoramenný							DUR190L, DUR190U, DUR191U, DUR369A, DUR369L, UR006G, UR007G	125520-4	4,29 €
	Jednoramenný									
Dvojramenný			DUR369A, UR002G, UR006G, UR007G	122906-3	17,99 €					
Dvojramenný PROFI			DUR368U, DUR369U, UR006G, UR012D	122A37-4	18,99 €					

## Žacie hlavy pre vyžinače



Vhodné pre model	Priemer/dĺžka	Tvar lanka	Obj. č.	MOC bez DPH
DUR180, DUR181	1,65 mm x 8 m	okruhlé	195858-1	5,09 €
DUR193D	1,65 mm x 8 m	štvorlistok	191Y39-5	8,59 €
UR3000		okruhlé	DA00000001	7,09 €

## Žací nôž plastový



Vhodné pre model	Žací nôž plastový				Náhradné čepele		
	Závit vretena	Šírka záberu	Obj. č.	MOC bez DPH	ks/ bal.	Obj. č.	MOC bez DPH
UR100D	M8x1.25RH	230mm	198848-3		5	198851-4	4,49 €
DUR187L, DUR187U, DUR188L, DUR190L, DUR190U, DUR191L, DUR191U, DUR188U, DUR189, DUR364L, DUR366L, DUR368A, DUR368L, DUR369A, DUR369L, DUR369N, UR001G, UR002G, UR003G, UR006G, UR007G, UR008G, UR016G, UR017G, UR101C, UR201C, UR202C, EM403MP, EM404MP, EM405MP, EM406MP	M8x1.25RH M8x1.25LH M10x1.25LH	255mm	198383-1		12	198426-9	7,89 €
DUR369A, DUR369L, DUR369N, UR101C, UR201C, UR202C, UR012G, UR013G	M10x1.25LH	305mm	199868-0		12	199870-3	8,39 €

# PRÍSLUŠENSTVO PRE ZÁHRADU

	model	popis	vhodný pre model	Obj. č.	MOC s DPH
	EM404MP	krovinorez šírka záberu: 300 mm (žacia hlava) 230 mm (žací nož kov, vrtanie 25,4 mm) závit vretena: M10 x 1.25 LH	DUX60, UX01G	126603-3	85,99 €
	EM407MP	rotačné nožnice šírka záberu: 230 mm	DUX18, DUX60, UX01G	191M56-3	499,99 €
	EM408MP	krovinorez šírka záberu: 300 mm (žacia hlava) 230 mm (žací nož kov, vrtanie 25,4 mm) závit vretena: M10 x 1.25 LH	DUX18, DUX60, UX01G	191N31-5	99,99 €
	UB400MP	fukár	DUX18, DUX60, UX01G	191F65-0	185,99 €
	UB401MP	fukár	DUX18, DUX60, UX01G	191P72-3	196,99 €
	UB402MP	fukár	DUX18, DUX60, UX01G	1912R8-4	86,99 €
	EY403MP	vyvetvovacia píla dĺžka lišty: 30 cm	DUX18, DUX60, UX01G	191T38-7	145,99 €
	EN400MP	nožnice na živé ploty s nastavením uhla	DUX18, DUX60, UX01G	196257-0	293,99 €
	EN420MP	nožnice na trávnu s nastavením uhla	DUX18, DUX60, UX01G	198054-0	289,99 €
	EN402MP	nožnice na živé ploty s nastavením uhla	DUX18, DUX60, UX01G	1912T8-8	159,99 €
	EN422MP	nožnice na trávnu s nastavením uhla	DUX18, DUX60, UX01G	1912T0-4	176,99 €
	EN424MP	nožnice lištové na trávnu	DUX18, DUX60, UX01G	1913C9-3	181,99 €
	EE400MP	orezávač trávnik	DUX18, DUX60, UX01G	196752-0	152,99 €
	PF400MP	vodná pumpa na čistú vodu	DUX18, DUX60, UX01G	DEAPF400MP	199,99 €
	KR400MP	kultivátor šírka: 160 mm	DUX18, DUX60, UX01G	195709-8	232,99 €
	KR401MP	kultivátor šírka: 220 mm	DUX18, DUX60, UX01G	199180-8	259,99 €
	BR400MP	nylónová kefa	DUX18, DUX60, UX01G	199317-7	469,99 €
	SW400MP	gumená kefa	DUX18, DUX60, UX01G	199338-9	439,99 €
	LE400MP	predĺženie 1 m	DUX18, DUX60, UX01G	191E24-8	64,99 €

## Pílové reťaze a lišty



### A Dĺžka lišty

Dĺžka lišty udáva priemer rezu, je olišniá od celkovej dĺžky



### B Vodiaci článok

Dĺžka pílovej reťaze sa určuje počtom vodiacich článkov

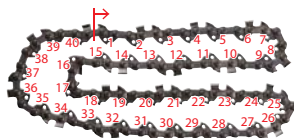

### C Delenie reťaze

Delenie reťaze je definované vzdialenosťou medzi akýmkoľvek tromi po sebe idúcimi nitmi delené dvoma. Delenie je dôležité, pretože hnacie ozubené koleso musí mať rovnaké delenie ako reťaz.



### D Šírka drážky lišty

Šírku drážky určuje šírka vodiaceho článku, je potrebné používať lištu aj reťaz s rovnakou šírkou.

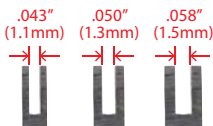

### E Vymedzovací zub

Vymedzovací zub určuje záber pílového zubu do dreva.



## Charakteristika pílových reťazi

D Šírka drážky lišty	C Delenie reťaze	Rýchlosť rezu			
		Rýchle	Pomalé		
0.043" (1.1mm)					
0.050" (1.3mm)					
0.058" (1.5mm)					
0.063" (1.6mm)					
	1/4"		25AP 25F		
	.325"LP	80			
	3/8"LP	90PX	91PX 91F 91VXL		
	.325"		20BPX 95VPX	21BPX 21LPX	22BPX 22LPX
	3/8"		72LPX 72V	73DPX 73LGX 73LPX	75LPX 75LPX
	.404"				27X 59AC

## Typy lišt

### Lišta s ozubeným kolesom

Ozubené koleso na špičke lišty zabezpečuje pohyb reťaze s menším trením.



### Lišty bez ozubeného kolesa

Špička lišty spevnená stelitom (zliatina kobaltu a chrómu), určená pre obzvlášť náročné práce s drevom v v lesoch po požiaroch a vo veľmi prašnom prostredí



### Carvingová lišta

Lišty vyrobené z vysoko kvalitnej ocele a stelitom, sú vysoko odolné voči opotrebovaniu. Špička lišty má malý priemer pre presné rezanie. Určené pre vyrezávanie a orezávanie presných tvarov.



## Ostrenie pílovej reťaze

### Okruhlý pilník s držiakom



Lepšie ostrenie reťaze vďaka pevnému uchytieniu pilníka držiaku. Držiak má vyznačené presné uhly ostrenia reťaze (30°) a zabraňuje pod brúseniu reťaze.

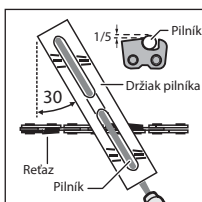

## Starostlivosť o lištu

### Napnutie reťaze

Pred použitím skontrolujte napnutie reťaze.



### Okraj lišty

Udržujte v 90° uhle pomocov plochého pilníka.



### Čistenie lišty

Čistite lištu pravidelne pri ostrení alebo výmene reťaze.



### Ozubené koleso lišty

Pravidelne premažte ozubené koleso lišty, pre bez problémový chod reťaze.

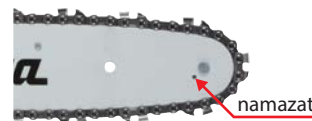

### Mierka reťaze

Pomocou mierky reťaze kontrolujete výšku vymedzovacieho zubu a plochým pilníkom ho zbrúsíte na požadovanú veľkosť.

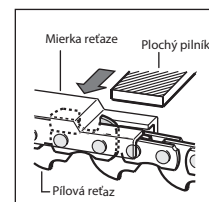
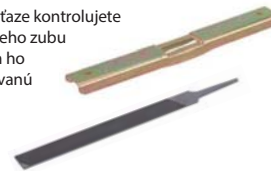

## Reťazové pily

### Lišty / pílové reťaze / kryty lišt / záberové koleso

Typ zubov: CC: dlátovitý, SC: polodlátovitý, MC: Mikro zub



Vhodné pre model	Lišta				Pílové reťaze							Kryt lišty		Záberové koleso		
	Dĺžka lišty	Typ lišty	Obj. č.	MOC s DPH	Počet vodiacich článkov	Šírka drážky lišty	Delenie reťaze	Typ reťaze	Typ zubov	Obj. č.	MOC s DPH	Obj. č.	MOC s DPH	Typ/delenie	Obj. č.	MOC s DPH

#### Vyvetvovacie pily

*EY401MP	25cm/10"	S ozubeným kolesom	191G11-9	12,99 €	39	1.3mm/.050"	3/8" LP	91VXL	SC	191H20-4	18,99 €	458501-6	3,39 €	Sprocket 3/8"LP	XTM0000014	3,07 €
*EY402MP	25cm/10"	S ozubeným kolesom	191G14-3	11,99 €	40	1.1mm/.043"	3/8" LP	90PX	CC	191H00-0	8,69 €	458501-6	3,39 €	Sprocket 3/8"LP	226992-7	2,25 €
*EY403MP	30cm/12"		191G15-1	16,99 €	46					191H01-8	14,99 €	419288-5	2,39 €			
DUA250	25cm/10"		191G22-4	12,99 €	40	191H08-4	12,89 €	458501-6	3,39 €							
DUA251	30cm/12"		191G23-2	13,99 €	46	191H10-7	11,99 €	419288-5	2,39 €							

#### Akumulátorové reťazové pily

DUC101	10cm/4"	Bez ozubeného kolesa	1910W0-3	15,99 €	26	1.1mm/.043"	.325" LP	80TXL	MC	1910V6-4	9,29 €	413M40-1	3,59 €	.325"LP	227947-5	2,96 €			
DUC100D	16cm/6-1/4"	Bez ozubeného kolesa	158476-6	19,99 €	42	1.3mm/.050"	1/4"	25AP	MC	191G95-7	18,99 €	416311-7	2,59 €	Sprocket 1/4"	221527-9	1,09 €			
DUC121, DUC122			191A1-3	60,99 €	60	1.3mm/.050"	1/4"	25AP	MC	191G96-5	23,99 €	458501-6	3,39 €	Sprocket 1/4"	198259-2	3,19 €			
DUC204 DUC254 DUC254C	25cm/10"	Carvingová lišta	191T85-8	13,99 €	46	1.1mm/.043"	3/8" LP	80TXL	MC	191T89-0	19,99 €	458501-6	3,39 €	.325"LP	1911W6-9	cena na vyžiadanie			
	30cm/12"	S ozubeným kolesom	191T86-6	13,99 €	51					191T90-5	24,99 €	419288-5	2,39 €						
	25cm/10"	S ozubeným kolesom	191G14-3	11,99 €	40	1.1mm/.043"	3/8" LP	90PX	CC	191H00-0	8,69 €	458501-6	3,39 €	Sprocket 3/8"LP	199063-2	2,50 €			
	30cm/12"		191G15-1	16,99 €	46					191H01-8	14,99 €	419288-5	2,39 €						
25cm/10"	S ozubeným kolesom	191G22-4	12,99 €	40	1.1mm/.043"	3/8" LP	91PX	CC	191H08-4	15,99 €	458501-6	3,39 €	Sprocket 3/8"LP	199063-2	2,50 €				
30cm/12"		191G23-2	13,99 €	46					191H10-7	11,99 €	419288-5	2,39 €							
DUC252 DUC302 DUC352 DUC252C	25cm/10"	Carvingová lišta	191A1-3	60,99 €	60	1.3mm/.050"	1/4"	25AP	MC	191G96-5	23,99 €	458501-6	3,39 €	Sprocket 1/4"	221528-7	7,21 €			
	25cm/10"	S ozubeným kolesom	191G14-3	11,99 €	40	1.1mm/.043"	3/8" LP	90PX	CC	191H00-0	8,69 €	458501-6	3,39 €	Sprocket 3/8"LP	221526-1	1,00 €			
	30cm/12"		191G15-1	16,99 €	46					1.1mm/.043"	191H01-8	14,99 €	419288-5				2,39 €		
	35cm/14"	191G16-9	13,99 €	52	1.1mm/.043"	191H02-6	11,99 €	419288-5	2,39 €										
	25cm/10"	S ozubeným kolesom	191G22-4	12,99 €	40	1.3mm/.050"	3/8" LP	91PX	CC	191H08-4	15,99 €	458501-6	3,39 €						
	30cm/12"		191G23-2	13,99 €	46					1.3mm/.050"	191H10-7	11,99 €	419288-5				2,39 €		
35cm/14"	191G24-0	13,99 €	52	1.3mm/.050"	191H11-5	12,99 €	419288-5	2,39 €											
DUC303 DUC353 DUC400 DUC305 DUC355 DUC405	25cm/10"	Carvingová lišta	191G61-4	cena na vyžiadanie	60	1.3mm/.050"	1/4"	25AP	MC	191G96-5	23,99 €	458501-6	3,39 €	Sprocket 1/4"	198259-2	3,19 €			
	25cm/10"	S ozubeným kolesom	191T85-8	13,99 €	46	1.1mm/.043"	.325" LP	80TXL	MC	191T89-0	19,99 €	458501-6	3,39 €	Sprocket .325"LP	199063-2	2,50 €			
	30cm/12"		191T86-6	13,99 €	51					191T90-5	24,99 €	419288-5	2,39 €						
	35cm/14"		191T87-4	16,99 €	59					191T91-3	23,99 €	419288-5	2,39 €						
	25cm/10"		191G14-3	11,99 €	40					191H00-0	8,69 €	458501-6	3,39 €						
	30cm/12"	S ozubeným kolesom	191G15-1	16,99 €	46	1.1mm/.043"	3/8" LP	90PX	CC	191H01-8	14,99 €	419288-5	2,39 €	Sprocket 3/8"LP	199063-2	2,50 €			
	35cm/14"		191G16-9	13,99 €	52					1.1mm/.043"	191H02-6	11,99 €	419288-5				2,39 €		
	40cm/16"	191G17-7	14,99 €	56	191H03-4	13,99 €	419242-9	3,69 €											
	25cm/10"	S ozubeným kolesom	191G22-4	12,99 €	40	1.3mm/.050"	3/8" LP	91PX	CC	191H08-4	15,99 €	458501-6	3,39 €						
	30cm/12"		191G23-2	13,99 €	46					1.3mm/.050"	191H10-7	11,99 €	419288-5				2,39 €		
35cm/14"	191G24-0	12,79 €	52	1.3mm/.050"	191H11-5	12,99 €	419288-5	2,39 €											
40cm/16"	191G25-8	14,99 €	56	1.3mm/.050"	191H12-3	13,99 €	419242-9	3,69 €											
DUC307 DUC357 DUC407 DUC353 DUC355	30cm/12"	S ozubeným kolesom	191G15-1	12,39 €	46	1.1mm/.043"	3/8" LP	90TXL	CC	191H01-8	14,99 €	419288-5	2,39 €				Sprocket 3/8"LP	199063-2	2,50 €
	35cm/14"		191G16-9	13,99 €	52					1.1mm/.043"	191H02-6	11,99 €	419288-5						
	40cm/16"	191G17-7	14,99 €	56	191H03-4	13,99 €	419242-9	3,69 €											
	30cm/12"	S ozubeným kolesom	191G23-2	13,99 €	46	1.3mm/.050"	3/8" LP	91PX	CC	191H10-7	11,99 €	419288-5	2,39 €						
	35cm/14"		191G24-0	13,99 €	52					1.3mm/.050"	191H11-5	12,99 €	419288-5	2,39 €					
	40cm/16"	191G25-8	14,99 €	56	1.3mm/.050"	191H12-3	13,99 €	419242-9	3,69 €										
DUC303 DUC353 DUC400 DUC305 DUC355 DUC405	25cm/10"	Carvingová lišta	191A1-3	60,99 €	60	1.3mm/.050"	1/4"	25AP	MC	191G96-5	23,99 €	458501-6	3,39 €	Sprocket 1/4"	198259-2	3,19 €			
	30cm/12"	S ozubeným kolesom	191T86-6	13,99 €	51	1.1mm/.043"	.325" LP	80TXL	MC	191T90-5	24,99 €	419288-5	2,39 €	Sprocket .325"LP	1911W6-9	cena na vyžiadanie			
	35cm/14"		191T87-4	16,99 €	59					1.1mm/.043"	191T91-3	23,99 €	419288-5				2,39 €		
	40cm/16"		191T88-2	19,99 €	64					191T92-1	26,99 €	419242-9	3,69 €						
	30cm/12"		191G15-1	16,99 €	46					191H01-8	14,99 €	419288-5	2,39 €						
	35cm/14"	S ozubeným kolesom	191G16-9	13,99 €	52	1.1mm/.043"	3/8" LP	90PX	CC	191H02-6	11,99 €	419288-5	2,39 €	Sprocket 3/8"LP	199063-2	2,50 €			
	40cm/16"		191G17-7	14,99 €	56					1.1mm/.043"	191H03-4	13,99 €	419242-9				3,69 €		
	30cm/12"	S ozubeným kolesom	191G23-2	13,99 €	46	1.3mm/.050"	3/8" LP	91PX	CC	191H10-7	11,99 €	419288-5	2,39 €						
35cm/14"	191G24-0		13,99 €	52	1.3mm/.050"					191H11-5	12,99 €	419288-5	2,39 €						
40cm/16"	191G25-8	14,99 €	56	1.3mm/.050"	191H12-3	13,99 €	419242-9	3,69 €											

Vhodné pre model	Lišta				Pílové reťaze							Kryt lišty		Záberové koleso		
	Dĺžka lišty	Typ lišty	Obj. č.	MOC s DPH	Počet vodiacich článkov	Šírka drážky lišty	Delenie reťaze	Typ reťaze	Typ zubov	Obj. č.	MOC s DPH	Obj. č.	MOC s DPH	Typ/delenie	Obj. č.	MOC s DPH
UC002G UC003G UC004G UC006G UC007G	25cm/10"	Carvingová lišta	1911A1-3	60,99 €	60	1.3mm/.050"	1/4"	25AP	MC	191G96-5	23,99 €	458501-6	3,39 €	Sprocket 1/4"	191V92-3	5,87 €
	25cm/10"		191T85-8	13,99 €	46					191T89-0	19,99 €	458501-6	3,39 €			
	30cm/12"	S ozubeným kolesom	191T86-6	13,99 €	51	1.1mm/.043"	.325" LP	80PX	MC	191T90-5	24,99 €	419288-5	2,39 €	Sprocket .325" LP	191V91-5	10,05 €
	35cm/14"		191T87-4	16,99 €	59					191T91-3	23,99 €	419288-5	2,39 €			
	25cm/10"		191G14-3	11,99 €	40					191H00-0	8,69 €	458501-6	3,39 €			
	30cm/12"	S ozubeným kolesom	191G15-1	16,99 €	46	1.1mm/.043"	3/8" LP	90PX	CC	191H01-8	14,99 €	419288-5	2,39 €			
	35cm/14"		191G16-9	13,99 €	52					191H02-6	11,99 €	419288-5	2,39 €			
	25cm/10"		191G22-4	12,99 €	40					191H08-4	15,99 €	458501-6	3,39 €			
	30cm/12"	S ozubeným kolesom	191G23-2	13,99 €	46	1.3mm/.050"	3/8" LP	91PX	CC	191H10-7	11,99 €	419288-5	2,39 €			
	35cm/14"		191G24-0	13,99 €	52					191H11-5	12,99 €	419288-5	2,39 €			
UC010G UC011G UC012G UC013G UC014G UC015G UC016G UC017G UC020G	30cm/12"	S ozubeným kolesom	191T86-6	13,99 €	51	1.1mm/.043"	.325" LP	80TXL	MC	191T90-5	24,99 €	419288-5	2,39 €	Sprocket .325" LP	191V91-5	10,05 €
	35cm/14"		191T87-4	16,99 €	59					191T91-3	23,99 €	419288-5	2,39 €			
	40cm/16"		191T88-2	19,99 €	64					191T92-1	26,99 €	419242-9	3,69 €			
	45cm/18"		191X03-0	22,99 €	70					191X04-8	27,99 €	419242-9	3,69 €			
	30cm/12"	S ozubeným kolesom	191G15-1	16,99 €	46	1.1mm/.043"	3/8" LP	90PX	CC	191H01-8	14,99 €	419288-5	2,39 €	Sprocket 3/8" LP	191V90-7	5,23 €
	35cm/14"		191G16-9	13,99 €	52					191H02-6	11,99 €	419288-5	2,39 €			
	40cm/16"		191G17-7	14,99 €	56					191H03-4	13,99 €	419242-9	3,69 €			
	30cm/12"		191G23-2	13,99 €	46					191H10-7	11,99 €	419288-5	2,39 €			
	35cm/14"		191G24-0	13,99 €	52					191H11-5	12,99 €	419288-5	2,39 €			
	40cm/16"		191G25-8	14,99 €	56					191H12-3	13,99 €	419242-9	3,69 €			
45cm/18"	191G26-6	15,99 €	62	191H13-1	14,99 €	419242-9	3,69 €									

## Elektrické reťazové píly

UC3041A, UC3541A, UC4041A	30cm/12"	S ozubeným kolesom	191G15-1	16,99 €	46	1.1mm/.043"	3/8"	90PX	CC	191H01-8	14,99 €	419288-5	2,39 €	Sprocket 3/8" LP	221526-1	1,00 €
	35cm/14"		191G16-9	13,99 €	52					191H02-6	11,99 €	419288-5	2,39 €			
	40cm/16"		191G17-7	14,99 €	56					191H03-4	13,99 €	419242-9	3,69 €			
	30cm/12"	191G23-2	13,99 €	46	191H10-7	11,99 €	419288-5	2,39 €								
	35cm/14"	191G24-0	13,99 €	52	191H11-5	12,99 €	419288-5	2,39 €								
	40cm/16"	191G25-8	14,99 €	56	191H12-3	13,99 €	419242-9	3,69 €								
UC3050A, UC3550A, UC4050A, UC3051A, UC3551A, UC4051A, UC4551A	30cm/12"	S ozubeným kolesom	191G23-2	13,99 €	46	1.3mm/.050"	3/8"	91PX	CC	191H10-7	11,99 €	419288-5	2,39 €	Sprocket 3/8" LP	221521-1	cena na vyžiadanie
	35cm/14"		191G24-0	13,99 €	52					191H11-5	12,99 €	419288-5	2,39 €			
	40cm/16"		191G25-8	14,99 €	56					191H12-3	13,99 €	419242-9	3,69 €			
	45cm/18"		191G26-6	15,99 €	62					191H13-1	14,99 €	419242-9	3,69 €			

### Karvingová lišta

250mm: Obj. č. 168395-8



Pílová reťaz 25AP-60 vodiacich článkov  
Obj. č. 194098-8

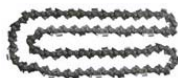

Ozubené koleso 1/4"

DUC204, DUC254, DUC254C, DUC303, DUC353, DUC400, DUC305, DUC355, DUC405, DUC256, DUC306, DUC356, DUC406, DUC256C: Part No. 198259-2

DUC252, DUC302, DUC352, DUC252C: 221528-7

UC002G, UC003G, UC004G, UC006G, UC007G: 191V92-3

### Puzdrá pre ručné píly



Model	Obj. č.	MOC s DPH
DUC101, UC100D	1911R0-4	17,99 €
DUC150	1913K4-9	21,99 €

### Uhlový prevod pre pílové nadstavce



Vhodné pre model	Obj. č.	MOC s DPH
UA001G, UA002G, UA003G, UA004G, DUA250, DUA251, DUA300, DUA301	1910J6-0	75,99 €

# PRÍSLUŠENSTVO PRE ZÁHRADU

Vhodné pre model	Lišta					Pílové reťaze						
	Dĺžka lišty	Typ lišty	Počet zubov	Obj. č.	MOC s DPH	Počet vodiacich článkov	Šírka drážky lišty	Delenie reťaze	Typ reťaze	Typ zubov	Obj. č.	MOC s DPH

## Pílové lišty a reťaze pre benzínové píly

PS-220 TH PS-221 TH	25 cm/10"	S ozubeným kolesom	7	191G22-4	12,99 €	40	1,3 mm/.050"	3/8"	91PX	CC	191H08-4	15,99 €		
*PS32C/TLC PS-35 C/TLC PS-310 TH PS-3410TH PS-350 SC PS-352 / TLC*	30 cm/12"	S ozubeným kolesom	7	191G23-2	13,99 €	46	1,3 mm/.050"	3/8"	91PX	CC	191H10-7	11,99 €		
	35 cm/14"		7	191G24-0	13,99 €	52	1,3 mm/.050"	3/8"	91PX	CC	191H11-5	12,99 €		
	40 cm/16"		7	191G25-8	14,99 €	56	1,3 mm/.050"	3/8"	91PX	CC	191H12-3	13,99 €		
PS-410, PS-411, PS-420 C PS-460 PS-500/C PS-550 PS-6100 PS-5105/C PS-4605	30 cm/13"	S ozubeným kolesom	7	191G38-9	15,99 €	56	1,3 mm/.050"	0.325"	95VPX	CC	191H22-0	17,99 €		
	38 cm/15"		7	191G33-9	37,99 €	64	1,3 mm/.050"	0.325"	95VPX	CC	191H23-8	20,99 €		
	45 cm/18"		7	191G34-7	44,99 €	72	1,3 mm/.050"	0.325"	95VPX	CC	191H24-6	26,99 €		
	38 cm/15"		7	191G50-9	29,99 €	56	1,5 mm/.058"	3/8"	73DPX	SC	191H42-4	19,99 €		
	45 cm/18"		7	191G51-7	35,99 €	64	1,5 mm/.058"	3/8"	73DPX	SC	191H43-2	22,99 €		
	38 cm/15"		7	191G45-2	35,99 €	64	1,5 mm/.058"	0.325"	21BPX	CC	191H35-1	19,99 €		
	45 cm/18"		7	191G46-0	34,99 €	72	1,5 mm/.058"	0.325"	21BPX	CC	191H36-9	24,99 €		
	38 cm/15"		7	191G50-9	29,99 €	56	1,5 mm/.058"	3/8"	73LPX	CC	191H42-4	19,99 €		
	45 cm/18"		7	191G51-7	35,99 €	64	1,5 mm/.058"	3/8"	73LPX	CC	191H50-5	23,99 €		
						191G52-5	38,99 €	72	1,5 mm/.058"	3/8"	73LPX	CC	191H52-1	24,99 €
	38 cm/15"		7	191G45-2	35,99 €	64	1,5 mm/.058"	0.325"	21LPX	CC	191H35-1	19,99 €		
	45 cm/18"		7	191G46-0	34,99 €	72	1,5 mm/.058"	0.325"	21LPX	CC	191H36-9	24,99 €		
	45 cm/18"		7	162A60-7	cena na vyžiadanie	68	1,5 mm/.058"	3/8"	73LPX	CC	191H51-3	24,99 €		
50 cm/20"	7	162A88-5	cena na vyžiadanie	72	1,5 mm/.058"	3/8"	73LPX	CC	191H52-1	24,99 €				

## Rolky reťazí

	Delenie reťaze	Šírka drážky		Počet článkov na kotúči*	Profil zubu**	Obj. č.	MOC (s DPH)
	3/8"	1,1 mm	0,043"	1637	HM	957 291 801	365,99 €

\* +/- 5 článkov na 1 kotúč

\*\* VM – hranatý profil zubu; HM – guľatý profil zubu

\*\*\* do vypredania zásob

# PRÍSLUŠENSTVO PRE ZÁHRADU

## Okrúhle pilníky

pre pilové reťaze  
\*s rukoväťou



Typ pilovej reťaze	Okrúhly pilník			Pilník s vodičkom		
	Priemer	Obj. č.	ks/bal	MOC s DPH	Obj. č.	MOC s DPH
25F, 25AP, 91P, 91PX, 91PXL, 91VXL, M91VXL	4.0mm	*744003-1	1	2,09 €	-	
		953003090	1	2,19 €	958500166 953030010	8,99 € 14,99 €
					D-70948	7,89 €
90PX, 90SG	4.5mm	953003100	1	2,19 €	953030020	14,99 €
		958500163	3	4,09 €	D-70954	8,29 €
95VPX, 95TXL, 20BPX, 21BPX, 22BPX, 20LPX, 21LPX, 22LPX, 082, 086, 686, 484	4.8mm	953003070	1	2,19 €	953030030	6,69 €
		958500164	3	4,09 €	D-70960	8,29 €
90PX, 90SG	5.2mm	953003110	1	2,19 €		
72V, 73V, 75V, 72APX, 72DPX, 73DPX, 75DPX, 72EXL, 73EXL, 75EXL, 72EXJ, 73EXJ, 75EXJ, 72LGX, 73LGX, 75LGX, 72JGX, 73JGX, 75JGX, 72JPX, 73JPX, 75JPX, 72LPX, 73LPX, 75LPX, 72RD, 73RD, 75RD, 496, 093, 099	5.5mm	953003040	1	2,19 €	958500169	8,99 €

\* dodávané s rukoväťou

## Plochy pilník, mierka reťaze



Plochy pilník			Mierka reťaze		Pilník plochy s držiakom	
Obj. č.	ks/bal	MOC s DPH	Obj. č.	MOC s DPH	Obj. č.	MOC s DPH
953003060	1		953100090		D-70998	6,09 €

## Rukoväť pilníka



ks/bal	Obj. č.	MOC s DPH
1	273646-7	2,29 €
1	D-67496	1,99 €

## Držiak káblov



Typ	Popis	Obj. č.	MOC s DPH
A	Držiak kábla na ruku	194679-8	4,68 €
B	Držiak kábla na opasok	194677-2	1,89 €
C	Úchytka kábla spojovacia	158024-1	0,96 €

## Olej na pilové reťaze

Popis		Obj. č.	MOC s DPH	MOC s DPH / 1l
Olej na pilové reťaze	Olej na mazanie pilovej reťaze s prímiesou adhezíva, ochrana voči opotrebovaniu a korózií, dobrá priľnavosť, viskozita za studena, univerzálne využite v lete i v zime.	1L 195093-1	5,29 €	5,29 €
		5L 1910T9-4	24,99 €	5,00 €
BIOTOP Olej na pilové reťaze	Rastlinný olej na mazanie pilových reťazí, biologicky rýchlo degradovateľný, neznečisťuje pôdu, spodné vody, ochrana voči opotrebovaniu a korózií, dobrá priľnavosť, viskozita za studena, univerzálne využite v lete i v zime. Splňa prísne požiadavky RAL UZ48 (environmentálna značka pre životné prostredie)	1L 1910U0-9	6,69 €	6,69 €

## Olej pre dvojtaktné motory 50:1

Popis		Obj. č.	MOC s DPH	MOC s DPH / 1l
	100 ml	195957-9	1,59 €	15,90 €
	1 l	980008607	6,79 €	6,79 €
	1 l s odmerkou	980008612	9,39 €	9,39 €

## Olej pre štvortaktné motorové kosačky a krovinořezy HD-30

Popis		Obj. č.	MOC s DPH	MOC s DPH / 1l
	100 ml	197010-7	5,09 €	50,90 €
	600 ml	980808620	3,99 €	6,65 €

## Čistiace a ochranné prostriedky

Popis		Obj. č.	MOC s DPH	MOC s DPH / 1l
Multifukčný olej	300 ml	1910U9-1	8,99 €	29,97 €
Prostriedok na čistenie pilových reťazí	500 ml	1910U4-1	10,99 €	21,98 €
vazelína na mazanie nožnic poltostrihov	80 ml	197439-7	6,09 €	76,13 €

## Vysávačky, dávkovače oleja, kanistre

Popis		Obj. č.	MOC s DPH
Vysávačka / striekačka oleja		664718000	47,47 €
Dávkovač oleja - pumpa		242072-1	2,59 €
Kanister priehľadný 5 l		949000033	18,99 €
Kanister zelený 20 l		949000039	44,99 €

# PRÍSLUŠENSTVO PRE ZÁHRADU

## Nožnice, kryty nožnic pre nožnice na trávnu



Vhodné pre model	Šírka strihu	1	2	3
		Nožnica	Kryt nožnice	Zberač trávy
DUM168, DUM604, UM600D, UM603D	160mm	195267-4	452055-5	457426-1
DUM111 UM110D	110mm	191N23-4	459011-6	454880-0

## Zmena nožnic na trávnu na nožnice na kríky

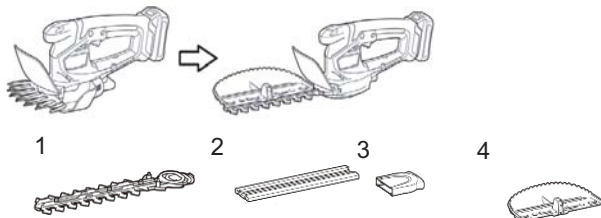

\*With clank cover

Vhodné pre model	1		Povrchová úprava
	Nožnica	MOC s DPH	
DUM111 DUM110	191N24-2	17,99 €	BLACK OXIDE
DUM604, UM600D, UM603D	198408-1	21,99 €	NICKEL PLATING

Vhodné pre model	2		4	MOC s DPH
	Kryt nožnice	MOC s DPH	Zberač odrezkov	
DUM111 DUM110	458342-0	7,29 €	198401-5	4,89 €
DUM604, UM600D, UM603D	458342-0	7,29 €	198401-5	4,89 €



## Nožnice pre plotostrihy

### Typ nožnice

#### A:

#### Optimálne pre hladké rezanie

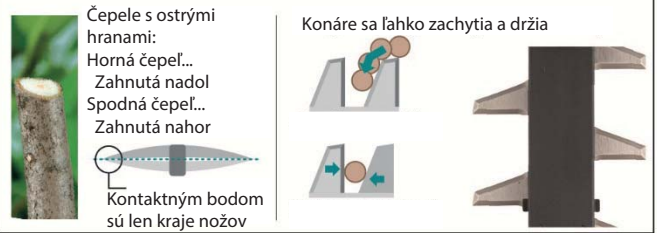

#### B: Nože s pevným úchopom

#### Horné / dolné zuby nožnice s nabrúsenými 3 hranami pre čistý a rýchly rez



#### C: Nože s poniklovanou povrchovou úpravou

#### Rovnomerne a silne prilhavá povrchová úprava, ktorá sa vyznačuje vysokou odolnosťou proti oderu.

#### Živica na nožoch (po 10 hodinovej práci)



Vhodné pre model	Veľkosť noža	Typ noža	Nôž		Kryt noža	
			Obj. č.	MOC s DPH	Obj. č.	MOC s DPH

Akumulátorové nožnice na živý plot

UH201D DUH202	200mm	C	198408-1	21,99 €	458342-0	7,29 €
DUH551	550mm	C			450489-6	4,99 €
DUH651	650mm	C	194674-8	68,13 €	450490-1	4,19 €
DUH523	520mm		195769-0	40,99 €	452685-2	5,19 €
DUH601	600mm	A	191R53-9	92,99 €	412911-1	8,79 €
DUH751	750mm	A	191R54-7	118,99 €	412912-9	9,19 €
DUH604S	600mm	A	191Y03-6	cena na vyžiadanie	459121-9	5,19 €
DUH754S	750mm	A	191Y05-2	cena na vyžiadanie	459122-7	9,49 €
DUH502	500mm	B	191T47-6	90,99 €	412768-0	cena na vyžiadanie
DUH602	600mm	B	191R57-1	95,99 €	412769-8	3,09 €
DUH507	500mm	A	1911J1-6	49,99 €	413L91-8	cena na vyžiadanie
DUH607	600mm	A	1911J2-4	54,99 €	413L92-6	cena na vyžiadanie
UH004G	600mm	A	191R53-9	92,99 €	412911-1	8,79 €
UH005G	750mm	A	191R54-7	118,99 €	412912-9	9,19 €
UH006G	600mm	B	191R55-5	167,99 €	412911-1	8,79 €
UH007G	750mm	B	191R56-3	182,99 €	412912-9	9,19 €
UH008G	600mm	B	191R57-1	95,99 €	459121-9	5,19 €
UH013G	600mm	A	191Y03-6	cena na vyžiadanie	413B98-4	cena na vyžiadanie
UH014G	750mm	A	191Y05-2	cena na vyžiadanie	413B99-2	cena na vyžiadanie



# PRÍSLUŠENSTVO PRE ZÁHRADU

Vhodné pre model	Veľkosť noža	Typ noža	Nôž		Kryt noža	
			Obj. č.	MOC s DPH	Obj. č.	MOC s DPH

Akumulátorové nožnice na živý plot

\*s chráničom noža, \*\*bez chrániča noža

DUN461W, DUN460W	460mm		191P00-8	41,99 €	413720-1	3,89 €
DUN500W	500mm		191C14-9	88,99 €	458413-3	21,99 €

Elektrické nožnice na živé ploty

UH4861	480mm	C	140830-8	30,14 €	452684-4	4,69 €
UH5261	520mm	C	140827-7	41,80 €	452685-2	5,19 €
UH4570	450mm	C	194661-7	59,95 €	450489-6	4,99 €
UH5570	550mm	C	194664-1	36,89 €	450489-6	4,99 €
UH6570	650mm	C	194667-5	59,99 €	450490-1	4,19 €
UH5580	550mm	C			450489-6	4,99 €
UH6580	650mm	C	194674-8	68,13 €	450490-1	4,19 €
UH7580	750mm	C	194676-4	76,63 €	450490-1	4,19 €

## Zberače odrezkov

• Pripevniteľné na obe strany noža



Vhodné pre model	Popis	Obj. č.	MOC s DPH
DUH202, *DUM111, *DUM604, UH201D, *UM110D, *UM600D, *UM603D	jednoduchá montáž / demontáž jedným zatlačením	198401-5	4,89 €
DUH483, DUH523, UH4261, UH4861, UH5261	5 ks skrutky M5 x 12 v balení	195050-9	20,99 €
DUH501, DUH502, DUH601, DUH602, DUH751, DUH752	jednoduchá montáž / demontáž jedným zatlačením	199151-5	20,99 €
DUH502, DUH602, DUH752	jednoduchá montáž / demontáž jedným zatlačením	199151-5	20,99 €
DUH507	jednoduchá montáž / demontáž jedným zatlačením	1910T1-0	50,99 €
DUH607	jednoduchá montáž / demontáž jedným zatlačením	1910T2-8	34,99 €
DUH504S, DUH604S, UH013G	Bez skrutiek v balení (obj.č. skrutiek 915211-3)	191D33-1	22,99 €
DUH754S, UH014G	Bez skrutiek v balení (obj.č. skrutiek 915211-3)	191D34-9	31,99 €
UH004G, UH006G, UH008G	jednoduchá montáž / demontáž jedným zatlačením	191R51-3	33,99 €
UH005G, UH007G, UH009G	jednoduchá montáž / demontáž jedným zatlačením	191R52-1	55,99 €
DUN461W UN460WD	jednoduchá montáž / demontáž jedným zatlačením	191T43-4	12,99 €

## Predĺženie pre nožnice na trávnu



Vhodné pre model	Obj. č.	MOC s DPH
DUM604, *DUH202, UM110D, DUM111, UM600D, UM603D, *UH201D	198516-8	49,99 €

## Strihacie nožnice

Nôž horný

Nôž spodný

Nepoužívajte opätovne  
zaistovaciu podložku E-4



Zaistovacia podložka E-4

So zaistovacou podložkou E-4 (obj.č. 961011-9)  
Potrebne objednať skrutky M3x6  
obj. č. 266183-8 a M8 251573-8

Vhodné pre model	Typ	Nôž horný		Nôž spodný	
		Obj. č.	MOC s DPH	Obj. č.	MOC s DPH
DUP361 DUP362	Štandard	197366-8	46,99 €	197367-6	43,99 €
	Pre tvrdé konáre	199216-3	71,99 €	199217-1	124,99 €
UP100D	Štandard	1911W2-5	13,99 €	1911W1-7	12,99 €
DUP180	Štandard	1913P4-4	cena na vyžiadanie	1913P3-6	cena na vyžiadanie

## Ostatné príslušenstvo pre nožnice na vinič a konáre

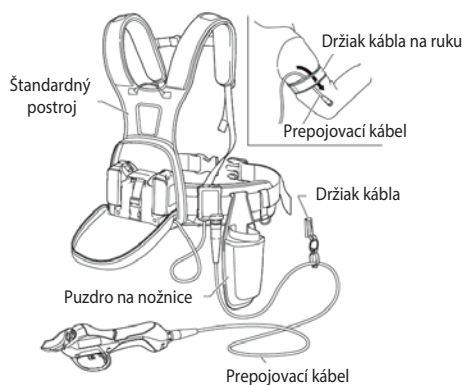

Vhodné pre model	Popis	Obj. č.	MOC s DPH
DUP361 DUP362	Štandardný postroj	161377-9	32,99 €
	Puzdro na nožnice	161379-5	8,29 €
DUP361 DUP362	Držiak kábla	154511-8	0,99 €
	Prepojovací kábel	661445-3	66,15 €
UP100 DUP180	Puzdro na nožnice	162C23-5	cena na vyžiadanie
DUP180	Prepojovací kábel	630E23-0	cena na vyžiadanie



Puzdro na nožnice  
UP100, DUP180



Prepojovací kábel  
DUP180

# PRÍSLUŠENSTVO PRE ZÁHRADU

## Nadstavce na fúrik

Vhodné pre model	Popis	Obj. č.	MOC s DPH
DCU180	 Rám	199009-8	270,99 €
	 Vaňa	199008-0	269,99 €
DCU602 DCU603 DCU604 DCU605	 Vaňa max. objem 200 l max. objem kvapaliny 100 l	191B69-8	995,99 €
	 Adaptér vyklápania	191B63-0	868,99 €
	 Rám	191B67-2	535,99 €
	 Adaptér vyklápania	191B63-0	868,99 €
	 Vaňa max. objem 295 l max. objem kvapaliny 250 l	1911B3-6	1 153,99 €

191B63-0; 1911B3-6 nie je možné použiť s modelom DCU602

## Kolieska pre fúriky

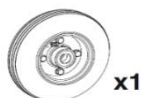
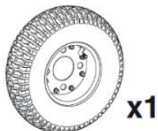







hodné pre model	Popis	Farba	Obj. č.	MOC s DPH
DCU601 DCU602 DCU603 DCU604 DCU605	Koleso pre použitie v exteriéri Ø 330 mm, pneumatika 13 x 5,00 - 6, dušová	čierna	1911K4-7	98,99 €
	Koleso pre použitie v interiéri, priemyselné podlahy, Ø 330 mm, pneumatika 13 x 5,00 - 6, dušová	sivá	1911K5-5	101,99 €
	Koleso pre použitie v interiéri, priemyselné podlahy Ø 210 mm, pneumatika 2,00 - 4, dušová	Šedá pneumatika nezanecháva čmuhu na podlahách	1911K6-3	69,99 €

## Nože pre kosačky s výsuvnými nožmi



Vhodné pre model	Bubon s výsuvnými nožmi			Náhradné nože		
	Veľkosť	Obj. č.	MOC s DPH	ks/bal.	Obj. č.	MOC s DPH
DLM462, DLM465	460 mm	191D49-6		4	191D47-0	32,99 €
DLM530, DLM531, DLM532, DLM533, DLM535, DLM536, DLM537, LM001C, LM002G	530 mm	191D50-1		4	191D48-8	37,99 €

## Náhradné valce pre elektrické vertikátory

Vhodné pre model	Obj. č.	MOC s DPH	
UV001G	 Prevzdušňovací nôž	1913J5-0	49,99 €
	 Pružinový valec	1913J7-6	46,99 €
UV3200	 Prevzdušňovací nôž	652024718	29,99 €
	 Pružinový valec	652024719	32,99 €
UV3600	 Prevzdušňovací nôž	652024746	25,99 €
	 Pružinový valec	652024750	20,99 €

## Mulčovacie klíny pre akumulátorové kosačky

Vhodné pre model	Obj. č.	MOC s DPH
DLM382 DLM432	191D46-2	25,99 €

## Nože pre motorové kosačky

Vhodné pre model	Obj. č.	MOC (s DPH)
PM42, PM43	664531043	10,99 €
PM48, PM48S, PM480, PM480S4	664531048	12,99 €
PM530, PM530S, PM5175S1, 5165S3, PM5360S3, PM5360S3E	664004381	13,99 €
PM4660S1, PM4655S4, PM4860/S/S4	664004366	14,99 €
PM5120/S/R	DA00000944	11,99 €
PM410, PM411C	671001433	13,99 €
PM46N/S/C, PM460, PM461R, PLM4628N	DA00001274	15,99 €
PLM5113N2, PM5100S3, PM5101S3/S3C, PM5102S3/S3C	DA00000973	18,99 €
PM5600S3/S3C/R, PLM5600N2	671002532	19,99 €

## Nože pre akumulátorové kosačky



Vhodné pre model	Obj. č.	MOC (s DPH)	
DLM300	330 mm	GB00000042	6,69 €
DLM380, DLM382	380 mm	191D41-2	11,99 €
LM003G	380 mm	1913H0-6	13,99 €
LM004G	430 mm	1913H4-8	18,99 €
DLM432	430 mm	191D43-8	14,99 €
DML460, DLM461, DLM463, DLM464	460 mm	199367-2	9,95 €
DLM462, DLM465	460 mm	191D51-9	22,99 €
DLM480, DLM481, LM001G	480 mm	191V97-3	23,99 €
DLM530, DLM531, DLM532, DLM533, DLM534, DLM535, DLM536, DLM537, DLM538, DLM539, LM001C, LM002G	530 mm	191W87-2	22,99 €
DLM538, DLM539, LM002G,	530 mm	191V96-5	30,99 €

## Mulčovacie nože

Vhodné pre model	Obj. č.	MOC (s DPH)	
LM004G	430 mm	1913H6-4	13,99 €

## Príslušenstvo pre akumulátorové zemné vrtáky DDG460 a DG001G



Vhodné na vrtanie do piesočnatej a hlinitej pôdy.

### Zemné vrtáky

Priemer	Celková dĺžka	Pracovná dĺžka	Obj. č.
<b>NEW</b> ø50 mm	800 mm	550 mm	E-13611
<b>NEW</b> ø60 mm			E-13627
<b>NEW</b> ø80 mm			E-13633
ø100 mm			E-07294
ø150 mm			E-07303
ø200 mm			E-07319

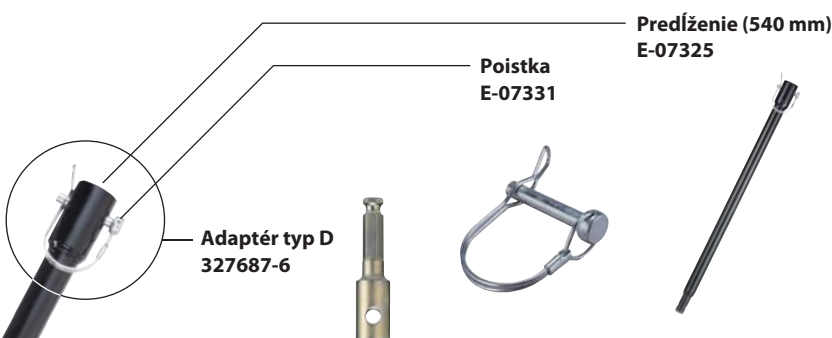

V porovnaní s našim predchádzajúcim vrtákom, ktorý má iba jednu špirálovú drážku, tento nový vrták má dve špirálové drážky, vďaka ktorým je vrtanie stabilnejšie. To tiež vedie k 10% zvýšeniu rýchlosti vrtania v porovnaní s predchádzajúcim vrtákom.

### Dva rôzne typy rezných nožov (plochý a zubový).

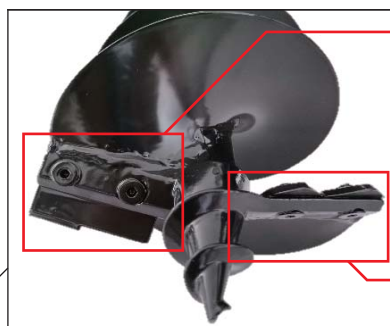

#### Plochý nôž



Plochý nôž, vhodný pre trávnaté plochy.

#### Zubový nôž



Zubový nôž, vhodný pre kamienkové pôdy.

### Nože pre zemné vrtáky

(sady nožov komplet)

Priemer	Obj. č.	Priemer	Obj. č.
<b>NEW</b> vrták 50 mm	E-13649	vrták 100 mm	E-07630
<b>NEW</b> vrták 60 mm	E-13655	vrták 150 mm	E-07646
<b>NEW</b> vrták 80 mm	E-13661	vrták 200 mm	E-07652

\*Priemer 200 mm používať iba pre piesočnatú pôdu.

## Príslušenstvo pre akumulátorové zemné vrtáky DDG460 a DG001G

### Príslušenstvo pre akumulátorový zemný vrták

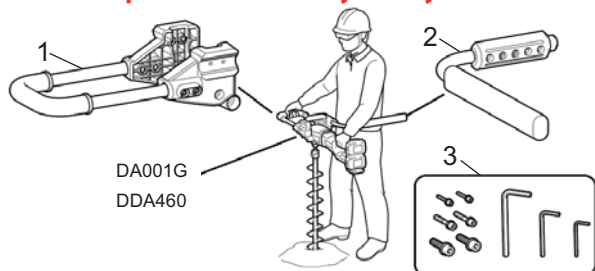

DA001G  
DDA460

Vhodné pre model	Popis	Obj. č.	MOC s DPH
DA001G, DA002G, DDA460	1-3set	191P11-3	100,99 €

### Adaptéry pre zemné vrtáky

Model		Obj. č.	MOC s DPH
DDG460, DG001G	20mm  pre vrtáky STIHL	327684-2	25,99 €
DA001G + 191P11-3	25.5mm  pre vrtáky Dolmar	327685-0	32,99 €
DDA460 + 191P11-3	20mm  pre vrtáky Makita	327687-6	21,99 €

### Zemné vrtáky



Priemer (mm)	Celková dĺžka (mm)	Pracovná dĺžka (mm)	Obj. č.	MOC (s DPH)
50	800	550	E-13611	67,99 €
60	800	550	E-13627	75,99 €
80	800	550	E-13633	81,99 €
100	800	550	E-07294	73,99 €
150	800	550	E-07303	85,99 €
200	800	550	E-07319	103,99 €

### Sety náhradných nožov nožov



Vrták priemer (mm)	Obj. č.	MOC (s DPH)
50	E-13649	7,89 €
60	E-13655	8,29 €
80	E-13661	8,89 €
100	E-07630	8,29 €
150	E-07646	9,29 €
200	E-07652	10,99 €

### Predĺženie



Dĺžka (mm)	Obj. č.	MOC (s DPH)
540	E-07325	23,99 €















### Zaistovacia poistka

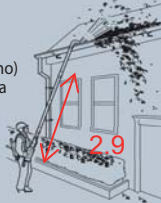

Obj. č.	MOC (s DPH)
E-07331	2,39 €

## Príslušenstvo pre fukáre

\*použitie len s adaptérom rúry 71  
 \*použitie len s adaptérom rúry 80-72  
 \*použitie len s adaptérom rúry 85-72  
 \*použitie len s adaptérom rúry MG

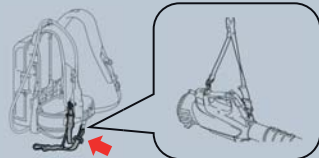
Vhodné pre model	Popis	Obj. č.	MOC s DPH
DUB184	Predaná rúra 	183P96-3	5,19 €
DUB362	Predĺžená rúra 	183R02-0	6,19 €
DUB363	Koncová rúra 72 	183R01-2	4,09 €
DUB363	Predĺžovacia rúra 90-72 	183R06-2	8,99 €
UB001C UB001G	Koncová rúra 80 	191P97-7	cena na vyžiadanie
DUB184** DUB362 DUB363 UB001C*** UB001G*** UB400MP**** UB401MP****	Dýza okrúhla 	197888-8	6,29 €
UB001C*** UB001G*** UB400MP**** UB401MP****	Dýzy ploché 	197889-6	3,89 €
DUB184** DUB362* DUB363 UB001C*** UB001G*** UB400MP**** UB401MP****	Sada na čistenie okapov (celková dĺžka 2,9 m)  sada obsahuje: 3 x rúra 0,9 m 1 x dýza (otočné koleno) 3 x sťahovacia objímka 	191B03-8	65,99 €
DUB362 DUB363	Rúra adaptér 71 	191J13-3	12,99 €
DUB184	Rúra adaptér 80-72 	191L13-5	3,99 €
UB001C UB001G	Rúra adaptér 85-72 	191L96-5	7,89 €
UB400MP UB401MP	Rúra adaptér MG 	191C15-7	8,79 €
UB001G DUB184 DUB362	Popruh jednoramenný 	166094-6	3,49 €
UB001C + PDC1200 UB001C + PDC01	Popruh 	191J48-4	cena na vyžiadanie

## Hubice pre fukáre

A: štandardne dodávané



Vhodné pre model	Dĺžka (mm)	Typ	Obj. č.	MOC s DPH
UB100D, UB101D, DUB185, DUB186	220	A	123245-4	3,89 €
	430	-	123246-2	11,99 €

## Predĺžená hubica



Vhodné pre model	Obj. č.	MOC s DPH
UB100D, UB101D, DUB183, DUB185, DUB186	191G09-6	4,49 €

## Zberný vak



Vhodné pre model	Obj. č.	MOC s DPH
UB100D, UB101D, DUB185, DUB186, UB1102, UB1103	123241-2	4,39 €
UB1100, UB1101	122321-1	3,49 €

## Príslušenstvo pre vysávanie

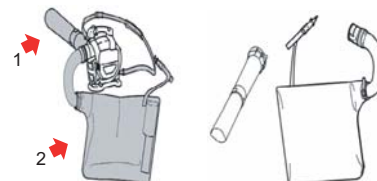

Vhodné pre model	Číslo	Popis	Obj. č.	MOC s DPH
DUB363	1+2	Sada na odsávanie	191E19-1	44,99 €
	2	Zberný vak	162988-3	24,99 €
DUB187		Dýza nasávania	GB00000165	4,99 €
		Zberný vak	GB00000185	18,99 €
		Jednoramenný popruh	GB00000038	cena na vyžiadanie



# VYSOKOTLAKOVÉ ČISTIČE

## Príslušenstvo pre vysokotlakové čističe DHW080, HW1200, HW1300, HV001G

Typ	Vhodné pre model	Obj. č.	MOC s DPH
Striekacia pištoľ 	DHW080 HW1200 HW1300	197842-2	18,99 €
Aretovateľná dýza 	DHW080 HW1200 HW1300	197822-8	9,59 €
Vario tryska set 	DHW080 HW1200 HW1300	191U88-8	23,99 €
Vario tryska set 	DHW080 HW1200 HW1300	1912Y4-1	16,99 €
Predĺženie 	DHW080 HW1200 HW1300	191U84-4	cena na vyžiadanie
Vario tryska 	DHW080 HW1200 HW1300	1912Y6-7	20,99 €
Turbo tryska 	DHW080 HW1200 HW1300	197824-4	9,89 €
Zahnutá tryska 	DHW080 HW1200* HW1300* (*for 110-127V)	197859-5	26,99 €
	HW1200** HW1300** (**for 220V-240V)	197859-5	26,99 €
Rotačná kefa 	DHW080 HW1200 HW1300	197831-7	12,99 €
Kefa 	DHW080 HW1200 HW1300	197828-6	6,49 €
Nádržka na saponát 	DHW080 HW1200 HW1300	1912Y2-5	15,99 €
Hadica na čistenie potrubia 	DHW080 HW1200 HW1300	10m 197837-5	25,99 €
		15m 197840-6	30,99 €

Typ	Vhodné pre model	Obj. č.	MOC s DPH
Spojka klbová 	DHW080 HW1200 HW1300	197867-6	20,99 €
Nasávací hadica 	DHW080 HW1200 HW1300	197873-1	28,99 €
Spojka trysky 	DHW080 HW1200 HW1300	197853-7	5,49 €
Nadstavec na ventil 	DHW080 HW1200 HW1300	197881-2	4,19 €
Čistiaca ihla 	DHW080 HW1200 HW1300	197879-9	2,39 €
Jednoramenný popruh 	DHW080	199486-4	7,69 €
Hadica 10 m 	HW1200	123784-4	17,99 €



# VYSOKOTLAKOVÉ ČISTIČE



	(Makita) HW1 02 (Dolmar) HP-20	(Makita) HW1 11 (Dolmar) HP-300	(Makita) HW1 12 (Dolmar) HP-350	(Makita) HW1 32 (Dolmar) HP-450	(Makita) HW1 51 (Dolmar) HP-7000	Obj. č.	MOC s Dph
Striekacia pištoľ	☺	☺	☺			3320152	8,89 €
Striekacia pištoľ				☺		3640920	18,99 €
Striekacia pištoľ					☺	41154	22,99 €
Aretovateľná dýza	☺					3640640	2,79 €
Aretovateľná dýza		☺	☺			3640650	3,39 €
Aretovateľná dýza				☺		3641150	7,99 €
Aretovateľná dýza					☺	40246	21,99 €
predlžovacia tyč 295 mm	☺	☺	☺			3320130	4,09 €
Vysokotlaková hadica 5 m	☺					3640630	8,79 €
Vysokotlaková hadica 8 m		☺	☺	☺		3640960	50,99 €
Vysokotlaková hadica 10 m					☺	3083550	70,99 €
Predlžovacia hadica 8 m	☺	☺	☺	☺		41181	113,99 €
Tryska napeňovacia		☺	☺	☺		3640670	1,79 €
Hadica na čistenie potrubia 8 m	☺	☺	☺	☺	☺	40863	38,99 €
Hadica na čistenie potrubia 16 m	☺	☺	☺	☺	☺	40864	69,99 €
Kefa na podlahy	☺	☺	☺	☺		41175	55,99 €
Kefa	☺	☺	☺	☺	☺	41185	18,99 €
Filter na vodu	☺	☺	☺	☺	☺	40855	15,99 €
Filter na vodu	☺	☺	☺	☺	☺	3082130	1,49 €
Kefa na podlahy s nádržkou na čistiaci prostriedok					☺	41849	57,99 €

Akumulátory  
 Odkladacie systémy  
 Vŕtanie  
 Skrutkovanie  
 Brúsky  
 Pilenie  
 Frézovanie  
 Brúsenie  
 Klince / spony  
 Špeciálne stroje  
 Vysávanie  
 Fény/lampy  
 Záhrada  
 Ručné náradie  
 Ostatné





# VYSOKOTLAKOVÉ ČISTIČE

	(Makita) HW101 (Dolmar) HP-10	(Makita) HW110 (Dolmar) HP-115	(Makita) HW130 (Dolmar) HP-135	(Makita) HW151 (Dolmar) HP-1500	Obj. č.	MOC s DPH
	☺				40797	16,99 €
	☺				40798	8,39 €
			☺		40719	13,99 €
				☺	40886	25,99 €
				☺	40867	43,99 €
	☺				3082290	17,57 €
		☺			40807	23,99 €
		☺	☺		40863	38,99 €
		☺	☺		40864	69,99 €
		☺	☺	☺	40855	15,99 €
				☺	41849	57,99 €









## SVIEČKY

zapaľovacie sviečky

	Zapaľovacia sviečka pre modely	Typ	Obj. č.	MOC (s DPH)
	PS-33, PS-330, PS-340/344, PS-400/401, PS-410/411	BPMR6F / NGK	965 603 018	<b>4,70 €</b>
	PS-2, PS-3, PS-4, PS-34, PS-36, PS-41, PS-43, PS-45, PS-3400 TH, PS-3410, PS-3410 TH, PS-350 C, PS-420 C, PS-460, PS-500, PS-500 C, PS-4600 S, PS-4605, PS-5000, PS-5105, PS-5105 C, PS-52, PS-630, PS-6100, PS-6400, PS-7300, PS-7310, PS-7900, PS-7910, PS-6000i, PS-6800i, PS-9000, PS-9010, 109, 110, 111, 115, 115i, LT-30, MS-20, MS-26, MS-2600, MS-24 U, MS-30 U, MS-30 C, MS-340, MS-3310, MS-400, MS-4010, MS-4200, MS-4211, MS-4510, PC-6112, PC-6114, PC-6212, PC-6412, PC-6414, PC-7414, PC-8116, PC-8216, 309, 343, PB-500 R, PD-520 R	BPMR7A / NGK	168517-0	<b>3,06 €</b>
	LT-250, MS-220, MS-250, MS-252, MS-2300, MS-3200, MS-3202, PB-250, HT-2256 D, HT-2276 E	BMR7A / NGK	168662-1	<b>2,41 €</b>
	MS-250.4, MS-252.4 U, MS-352.4 U, MS-245.4U/UE, MS-335.4U, PS-222 TH, PS-32 C, PS-35 C, PB-7600.4	CMR6A / NGK	168401-9	<b>3,79 €</b>

## PRÍSLUŠENSTVO

kombinované kľúče

		Obj. č.	MOC (s DPH)
	Kombinovaný kľúč 13/16 pre hobby píly.	941 716 132	<b>2,19 €</b>
	Kombinovaný kľúč 13/16 pre farmárske píly.	782026-1	<b>2,79 €</b>
	montážny kľúč 13 / 16	782023-7	<b>1,99 €</b>
	Kombinovaný kľúč 19/13 pre profi píly.	782033-4	<b>2,19 €</b>
	Kombinovaný kľúč 17/19 pre profi píly.	941 717 192	<b>1,49 €</b>
	Kombinovaný kľúč 13/19 pre hobby píly.	782028-7	<b>2,09 €</b>
	Kombinovaný kľúč 13 pre elektrické píly.	941 713 001	<b>1,79 €</b>



Žacie hlavy pre elektrické a motorové krovinořezy

Popis	Priemer lanka (mm)	Závit vretena	Vhodné pre modely	Obj. č.	MOC (s DPH)
Tap&Go	2	M8x1,25	ET71C, ET101C, UR3500, UR3501	YA00000649	9,46 €
Tap&Go	2	M10x1,25LH	ET110c, UR3502	YA00000681	12,99 €
Tap&Go	3	M10x1,25LH	EM4350, EM4351, MS-430, MS4300,4	196053-6	42,99 €
Tap&Go	3	M10x1,25LH	MS34, CS246,4, MS245,4, MS246,4, MS335,4	B-06507	18,99 €
AUTOMATIC	2,4	M8x 1,25RH	LT250, LT245,4	B-70518	19,99 €

Ochranné kryty pre krovinořezy

Popis	Vhodné pre modely	Obj. č.	MOC (s DPH)
Kryt komplet	EM3400U, EM4250, EM4251, EN4340, EM4341, MS3202, MS34, MS351,4, MS4200E	140421-9	cena na vyžiadanie
Kryt žacej hlavy	ET101C, ET71C, UR3500, UR3501	YA00000653	5,73 €
Kryt žacej hlavy	ET40, UR3000	DA00000047	5,57 €
Kryt komplet	MS20, MS22	6198014001	19,92 €
Kryt žacej hlavy	EM2600, MS27	DA00000526	5,00 €
Kryt noža	EM2600, MS27	DA00000525	7,53 €
Kryt komplet	MS26	6258064001	20,76 €
Kryt noža	MS26	6258065001	13,30 €
Kryt komplet	MS4200E	6358008004	42,50 €
Kryt noža	MS245,4, MS246,4, EBH252, EBH253	452260-4	7,48 €
Násuvný kryt pre kryt noža 452260-4 a 452259-9	MS245,4, MS246,4, EBH252, EBH253, EBH341, EM4350, EM4351, MS335,4, MS430,4, MS4300,4	135753-3	6,14 €
Kryt noža	EBH341, EM4350, EM4351, MS335,4, MS430,4, MS4300,4	452259-9	7,48 €
Kryt komplet	MS252	6258060002	18,83 €
Kryt noža	MS452	6258061002	11,62 €
Kryt žacej hlavy	MS3310, MS4010, MS4011, MS4510, MS4511	010341612	45,99 €
Kryt noža	MS3310, MS4010, MS4011, MS4510, MS4511	010341030	24,38 €

Unášače a skrutky pre elektrické kosačky

Popis	Vhodné pre modely	Obj. č.	MOC (s DPH)
Unášač noža	EM380, ELM3800	DA00000917	1,51 €
Unášač noža	EM3311, EM3511, EM3713, EM3913	664465602	11,38 €
Unášač noža	EM4818	664998186	13,26 €
Unášač noža	EM33, EM37, EM330, EM370	671492001	10,99 €
Unášač noža	ELM4610, ELM4611, ELM4613, EM460, EM461	671005057	5,98 €
Unášač noža	ELM4620, ELM4621, EM462, EM463	YA00001066	1,98 €
Skrutka noža	EM3311, EM3511, EM3713, EM3913	664004352	5,19 €
Skrutka noža	EM4818	664793101	1,00 €
Skrutka noža	EM380, ELM3800, ELM4610, ELM4611, EM41, EM460	671 006 017	0,48 €
Skrutka noža	ELM3320, ELM3720, ELM4120, ELM4121, EM331, EM371, EM410, EM411	YA00000827	0,59 €
Skrutka noža	ELM4620, ELM4621, EM462, EM463	YA00001067	1,59 €





## Unášače a skrutky pre motorové kosačky

Popis	Vhodné pre modely	Obj. č.	MOC (s DPH)
Unášač noža	PLM4630, PLM4631, PLM4632, PLM5130, PLM5600, PM460, PM4602, PM462, PM5102, PM5600	DA00000857	7,25 €
Unášač noža	PM42, PM43, PM48, PM480, PM530, PM4860	664463012	15,75 €
Unášač noža	PM4660S1, PM5175S1, PM4860S, PM2360S3, PM5360S3E, PM5365S3PRO	664465607	26,94 €
Unášač noža	PLM5120, PLM5120N2, PM5120, PM5120R	671002051	6,09 €
Unášač noža	PLM5121, PLM5121N2, PM5120S, PM5120R	671002049	7,71 €
Unášač noža	PLM4627, PLM4628, PM46B, PM46BC, PM46NB, PM46SB, PM46SBC	671002448	6,19 €
Unášač noža	PM4655S4, PM5165S3	664465608	26,90 €
Skrutka noža	PM42, PM43, PM48, PM480, PM530, PM4860, PM4660S1, PM5175S1, PM4860S, PM2360S3, PM5360S3E, PM5365S3PRO, PM4655S4, PM5165S3	664735698	3,19 €
Skrutka noža	PLM4630, PLM4631, PLM4632, PLM5130, PLM5600, PM460, PM4602, PM462, PM5102, PM5600	DA00000528	0,96 €

## Mulčovacie klíny pre elektrické a motorové kosačky

Popis	Vhodné pre modely	Obj. č.	MOC (s DPH)
Mulčovací klin	ELM4121, EM411	YA00000978	12,44 €
Mulčovací klin	PLM4627, PLM4628, PM46B, PM46BC, PM46NB, PM46SB, PM46SBC	671326001	9,29 €
Mulčovací klin	AM3746, DLM460, DLM463, ELM4610, ELM4611, EM460, PLM4610, PLM4620, PLM4621, PL4622, PM460, PM4601, PM461	671660001	10,99 €
Mulčovací klin	PLM5600, PM5600	671315001	11,89 €









## klíny

		Obj. č.	MOC (s DPH)
	Klin plastový 14 cm.	945 900 001	10,99 €
	Klin plastový 20 cm.	988 070 819	7,69 €
	Klin plastový 25 cm.	988 070 824	8,19 €
	Klin hliníkový – duralový 26 cm.	988 070 101	36,99 €
	Klin z tvrdého dreva pre nasadzovanie násad na sekery, kladivá 43 mm.	988 090 090	0,69 €
	Klin z tvrdého dreva pre nasadzovanie násad na sekery, kladivá 50 mm.	988 090 080	0,69 €

## kriedy







		Obj. č.	MOC (s DPH)
	Označovacia krieda modrá 12 ks/bal	988 050 730	11,99 €

## ŽACIE HLAVY

		Vhodné pre modely	Obj. č.	MOC (s DPH)
	žacia hlava	MS-260 U, MS-330 U, MS-430 U	B-06507 /351 502 030/	<b>18,99 €</b>
	adaptér	MS-260 U, MS-330 U, MS-430 U	351 502 034	<b>7,98 €</b>
	veko hlavy	MS-20U, MS-26U, MS-245.4U,UE, MS-335.4U, MS-252U, MS-3202, MS-246.4 U/UE, MS-24U, CS-246.4 C/CBC, MS-247.4 CE	B-70390	<b>3,71 €</b>
	vnútorné telo hlavy	MS-20U, MS-26U, MS-245.4U,UE, MS-335.4U, MS-252U, MS-3202, MS-246.4 U/UE, MS-24U, CS-246.4 C/CBC, MS-247.4 CE	A-15986	<b>1,87 €</b>
	bubon silónu	MS-20U, MS-26U, MS-245.4U,UE, MS-335.4U, MS-252U, MS-3202, MS-246.4 U/UE, MS-24U, CS-246.4 C/CBC, MS-247.4 CE	A-15970	<b>3,19 €</b>
	očko nylónovej hlavy	MS-20U, MS-26U, MS-245.4U,UE, MS-335.4U, MS-252U, MS-3202, MS-246.4 U/UE, MS-24U, CS-246.4 C/CBC, MS-247.4 CE	A-15992	<b>2,85 €</b>
	kryt hlavy – domec	MS-20U, MS-26U, MS-245.4U,UE, MS-335.4U, MS-252U, MS-3202, MS-246.4 U/UE, MS-24U, CS-246.4 C/CBC, MS-247.4 CE	A-16003	<b>12,99 €</b>
	pružina	MS-20U, MS-26U, MS-245.4U,UE, MS-335.4U, MS-252U, MS-3202, MS-246.4 U/UE, MS-24U, CS-246.4 C/CBC, MS-247.4 CE	A-16097	<b>2,99 €</b>
	adaptér M10 (LH)	MS-20U, MS-26U, MS-245.4U,UE, MS-335.4U, MS-252U, MS-3202, MS-246.4 U/UE, MS-24U, CS-246.4 C/CBC, MS-247.4 CE	A-16031	<b>3,16 €</b>

		Vhodné pre modely	Obj. č.	MOC (s DPH)
	kryt hlavy spodný	MS-30C,U, MS-340 U, MS-400 U, MS-3310 U, MS-4010 U, MS-4011 U, MS-4510 U, MS-4511 U	384 224 520	<b>10,01 €</b>
	krytka nyl. hlavy spodná	MS-30C,U, MS-340 U, MS-400 U, MS-3310 U, MS-4010 U, MS-4011 U, MS-4510 U, MS-4511 U	384 224 530	<b>10,27 €</b>
	pružina	MS-30C,U, MS-340 U, MS-400 U, MS-3310 U, MS-4010 U, MS-4011 U, MS-4510 U, MS-4511 U	384 224 510	<b>2,14 €</b>
	adaptér (M10 × 1,25 L)	MS-30C,U, MS-340 U, MS-400 U, MS-3310 U, MS-4010 U, MS-4011 U, MS-4510 U, MS-4511 U	387 224 590	<b>4,71 €</b>
	adaptér (M12 × 1,5 L)	MS-30C,U, MS-340 U, MS-400 U, MS-3310 U, MS-4010 U, MS-4011 U, MS-4510 U, MS-4511 U	385 224 550	<b>4,59 €</b>
	skrutka hlavy horná	MS-30C,U, MS-340 U, MS-400 U, MS-3310 U, MS-4010 U, MS-4011 U, MS-4510 U, MS-4511 U	384 224 540	<b>6,40 €</b>
	očko nylónovej hlavy	MS-30C,U, MS-340 U, MS-400 U, MS-3310 U, MS-4010 U, MS-4011 U, MS-4510 U, MS-4511 U	385 224 560	<b>3,15 €</b>
	žacia hlava	MS-430.4 U, MS-4300.4 U	196053-6	<b>42,99 €</b>
	kryt hlavy vrchný	MS-430.4 U, MS-4300.4 U	453957-8	<b>6,19 €</b>
	kryt hlavy spodný	MS-430.4 U, MS-4300.4 U	453960-9	<b>6,25 €</b>
	Tap & Go tlačítko	MS-430.4 U, MS-4300.4 U	453961-7	<b>2,91 €</b>
	bubon silónu	MS-430.4 U, MS-4300.4 U	453958-6	<b>4,22 €</b>
	prevodová doska	MS-430.4 U, MS-4300.4 U	453956-0	<b>5,17 €</b>
	pružina	MS-430.4 U, MS-4300.4 U	234260-4	<b>2,41 €</b>
	pružina	MS-430.4 U, MS-4300.4 U	234259-9	<b>5,09 €</b>
skrutka hlavy M10	MS-430.4 U, MS-4300.4 U	318918-4	<b>4,44 €</b>	
očko nylónovej hlavy	MS-430.4 U, MS-4300.4 U	318917-6	<b>1,41 €</b>	
platnička	MS-430.4 U, MS-4300.4 U	453955-2	<b>4,41 €</b>	

## ŽACIE HLAVY

		Vhodné pre modely	Obj. č.	MOC (s DPH)
	žacia hlava	MS-20 U, MS-26 U, MS-252 U, MS-27 U	DA00000500	<b>13,99 €</b>
	kryt hlavy spodný	MS-20 U, MS-26 U, MS-252 U, MS-27 U	DA00000168	<b>3,05 €</b>
	bubon silónu	MS-20 U, MS-26 U, MS-252 U, MS-27 U	DA00000166	<b>3,50 €</b>
	kryt hlavy – domec	MS-20 U, MS-26 U, MS-252 U, MS-27 U	DA00000440	<b>5,05 €</b>
	pružina	MS-20 U, MS-26 U, MS-252 U, MS-27 U	DA00000165	<b>0,84 €</b>
	podložka spodná	MS-20 U, MS-26 U, MS-252 U, MS-27 U	DA00000164	<b>0,39 €</b>
	podložka vrchná	MS-20 U, MS-26 U, MS-252 U, MS-27 U	DA00000164	<b>0,39 €</b>

# prevodník strojov Makita/Dolmar

Dolmar	Makita
AH-1848	UH482DW
AH-1852	UH522DZ
AH-1852 H	DUH523Z
AK-3622	UK360
AL-3630	BUR360Z
AM-3643	LM430DZ
AS-1212	DUC122DZ
AS-1813	DUC122
AS-3625	DUC250
AS-3626	DUC252
AT-1826	UR180DZ
AT-1826 H	DUR181Z
AX-1820	UM167DZ
AX-1820 H	DUM168Z
SP-1815	BVF154RF
PB-250	RBL250, EUB251
PB-250.4	BHX2500
PB-250.4 V	BHX2510
PB-252.4	BHX2501
PB-252.4 V	BHX2511
PB-7600.4	BBX7600
PB-7600.4	BBX7600
CS-246.4 C	EX2650L
ET-100 C	UM4030
ET-40	UR3000
ET-70 C	UM3830
ET-101C	UR3501
ET-110C	UR3502
LT-245.4	ER2550LH
LT-250	RST250
LT-30	DST300
MS-20 C	RBC201
MS-20 U	RBC200, MEM201
MS-22 C	RBC2110
MS-23 C	EM2301L
MS-23 U	EM2301U
MS-230 C	BCM2310
MS-24 U	EM2500U
MS-245.4 C	EBH252L
MS-245.4 CE	EBH253L
MS-245.4 U	EBH252U
MS-245.4 UE	EBH253U
MS-246.4 C	EM2650L
MS-246.4 CE	EM2651L
MS-246.4 UE	EM2651U
MS-25 C	DBC251
MS-25 CS	DBC251S
MS-25 U	DBC250
MS-25 US	DBC250S
MS-251.4	EM4251, MEM425
MS-252	RBC2500
MS-252.4 C	BCX2510

Dolmar	Makita
MS-252.4 U	BCX2500
MS-253	RBC2510
MS-26 C	DBC260L
MS-26 U	DBC260U
MS-260 C	BCM2610
MS-260 U	BCM2600
MS-290 C	DBC291
MS-290 U	DBC290
MS-30 C	DBC301
MS-30 U	DBC300
MS-3202	RBC3101
MS-330 C	BCM3310
MS-330 U	BCM3300
MS-3310	DBC3310
MS-335.4 U	EBH341U
MS-340	DBC340
MS-352.4 C	BCX3410
MS-352.4 R	EBH341R
MS-352.4 U	BCX3400
MS-400	DBC400
MS-4010	DBC4010
MS-4200 E	RBC420E
MS-4205	RBC412U
MS-4211	RBC421L
MS-430 U	BCM4300
MS-430.4 C	EM4350LH
MS-430.4 U	EM4350UH
MS-4300.4 U	EM4351UH
MS-4510	DBC4510
PE-251	ETR2500
ES-152 A	UC3001A
ES-162 A	UC3501A
ES-172 A	UC4001A
ES-2035 A	UC3503A
ES-2040 A	UC4003A
ES-2135 AP	UC3530AP
ES-2140 AP	UC4030AP
ES-33 A	UC3020A
ES-38 A	UC3520A
ES-42 A	UC4020A
109	DCS430
111	DCS520
115	DCS5200
109 Happy Start	DCS431, DE4345
PS-221 TH	DCS231T
PS-222 TH	DCS232TH
PS-32 C	MEA3200S
PS-32 C TLC	EA3201S
PS-34	DCS34
PS-340	DCS340
PS-341	DCS341
PS-3410	DCS3410

Dolmar	Makita
PS-3410 TH	DCS3410TH
PS-35	EA3502S
PS-35 C	EA3500S
PS-35 C TLC	EA3501S
PS-35 TLC	EA3503S
PS-350	DCS3500, MDE350
PS-350	DCS3500, MDE350
PS-350 C	DCS3501, MDE354
PS-350 S	EA3501F
PS-350 SC	EA3500F
PS-400	DCS400, MDE400
PS-401	DCS401, DE4040
PS-410	DCS410
PS-411	DCS411
PS-420	DCS4300, MDE430
PS-420 C	DCS4301, MDE435
PS-420 C	DCS4301, MDE435
PS-420 S	EA4301F
PS-420 SC	EA4300F
PS-45	DCS4610
PS-460	DCS460
PS-4600 S	DCS4600S
PS-4600 SH	DCS4600SH
PS-4605	DCS4630
PS-500	DCS500
PS-500 C	DCS5121
PS-5000	DCS5000
PS-5000 D	DCS5001, DE5045
PS-5000 H	DCS5000H
PS-5000 HD	DCS5001H
PS-5105	DCS5030
PS-5105 C	EA5000P
PS-5105 D	DCS5031
PS-6100	EA6100P
PS-6400	DCS6400
PS-7300	DCS7300
PS-7310	EA7300P
PS-7900	DCS7900
PS-7900	DCS7901
PS-7910	EA7900P
PS-9010	DCS9010
PD-491	PD491
PD-520	BBA520
HT-140	UH4050
HT-148	UH4850
HT-155	UH5550
HT-163	UH6350
HT-345	UH4570
HT-355	UH5570
HT-365	UH6570
HT-42	UH4260
HT-43	UH4261

Dolmar	Makita	Dolmar	Makita	Dolmar	Makita
HT-4500	UH4540	PM-4600 S	PLM4611	MH-2556	PTR2500
HT-48	UH4860	PM-4600 S3	PLM4612	EE-150	UW2500
HT-49	UH4861	PM-4601 S	PLM4621	MP-245.4	MEW1050H
HT-52	UH5260	PM-4601 S3	PLM4622	MP-245.4 Z	EW1050HX
HT-53	UH5261	PM-4602 S	PLM4631	MP-335.4	MEW1060H
HT-5500	UH5540	PM-4602 S3	PLM4632	MP-335.4 Z	EW1060HX
HT-5510	UH5580	PM-461	PLM4620	MP-352.4	EPH1000
HT-6500	UH6540	PM-462	PLM4630	MP-352.4 Z	EPH1000
HT-6510	UH6580	PM-4655 S4	PLM4816	HP-10	HW101
HT-7510	UH7580	PM-4660 S1	PLM4815	HP-115	HW110
HT-2249 D	HTR4901	PM-48	PLM4600	HP-135	HW130
HT-2350 D	EH5000W	PM-48 S	PLM4601	HP-1500	HW131
HT-2360 D	EH6000W	PM-480	PLM4602	HP-20	HW102
HT-2375 D	EH7500W	PM-480 S4	PLM4603	HP-300	HW111
HT-245	HTS4500	PM-4855 SA pro	PLM4814	HP-350	HW112
HT-2460	EH6000S	PM-4860	PLM4810	HP-400	HW121
HT-2475	EH7500S	PM-4860	PLM4810	HP-450	HW132
HT-255	HTS5500	PM-4860 S	PLM4811	HP-6000	HW140
HT-2556 D	HTR5600	PM-4860 S4	PLM4812	HP-7000	HW151
HT-2576 E	HTR7610	PM-4860 S4E	PLM4813	HP351	HW1200
HT-2950	HTS5000	PM-5100 S3	PLM5102	HP401	HW1300
HT-2960	HTS6000	PM-5101 S3	PLM5113	EV-3213	UV3200
HT-2975	HTS7500	PM-5101S3R	PLM5113N2	EV-3618	UV3600
EM-33	ELM3310	PM-5102 S3	PLM5130	EV-3918	UV380
EM-330	ELM3311	PM-5120	PLM5120	PV-3936	EUV400
EM331	ELM3320	PM-5120 S	PLM5121	FH-2500	UD2500
EM-3511	ELM3300	PM-5165 S3	PLM5115	SP-7600.4	PM7650H
EM-37	ELM3710	PM-5175 S1	PLM5114	EP-132	PF0800
EM371	ELM3720	PM-530	PLM5100	EP-144 D	PF1010
EM-370	ELM3711	PM-530 S	PLM5101	EP-1500 DS	PF1110
EM-3913	ELM3700	PM-5360 S3	PLM5110	EP-1680 S	PF1100
EM-41	ELM4110	PM-5360 S3E	PLM5112	EP-720 S	PF0403
EM410	ELM4120	PM-5365 S3 pro	PLM5111	EP-84	PF0300
EM411	ELM4121	PM-5600 S3	PLM5600	EP-84 D	PF0410
EM-4316	ELM4100	PM-5600S3R	PLM5600N2	EP-960 DS	PF0610
EM-460	ELM4610	RM-63.7	PRM0600		
EM-460 S	ELM4611	RM-72.13 H	PRM0700		
EM-461	ELM4612	TM-102.16	PTM1000		
EM-461 S	ELM4613	TM-102.16 H2	PTM1003		
EM462	ELM4620	TM-102.18 H	PTM1001		
EM463S	ELM4621	TM-102.20 H2	PTM1002		
EM-4818	ELM4600	TM-122.22 H2	PTM1200		
EM-4818 S	ELM4601	TM-92.14	PTM0900		
PM-410	PLM4110	TM-92.14 H	PTM0901		
PM-411	PLM4120	TM-92.14 H2	PTM0903		
PM-42	PLM4100	TM-98.14 H2D	PTM0902		
PM-43	PLM4101	TM-98.14 H2D	PTM0902		
PM-46	PLM4616	RM-72.13 H	PRM0700		
PM-46 N	PLM4617	LS-6002	MLS6000		
PM-46 S	PLM4618	MH-246.4 D	EN4950H		
PM46SBC	PLM4628	MH-246.4 DS	EN5950SH		
PM-460	PLM4610	MH-246.4 ES	EN7350SH		



# PRÍSLUŠENSTVO

## ▣ Ručné náradie

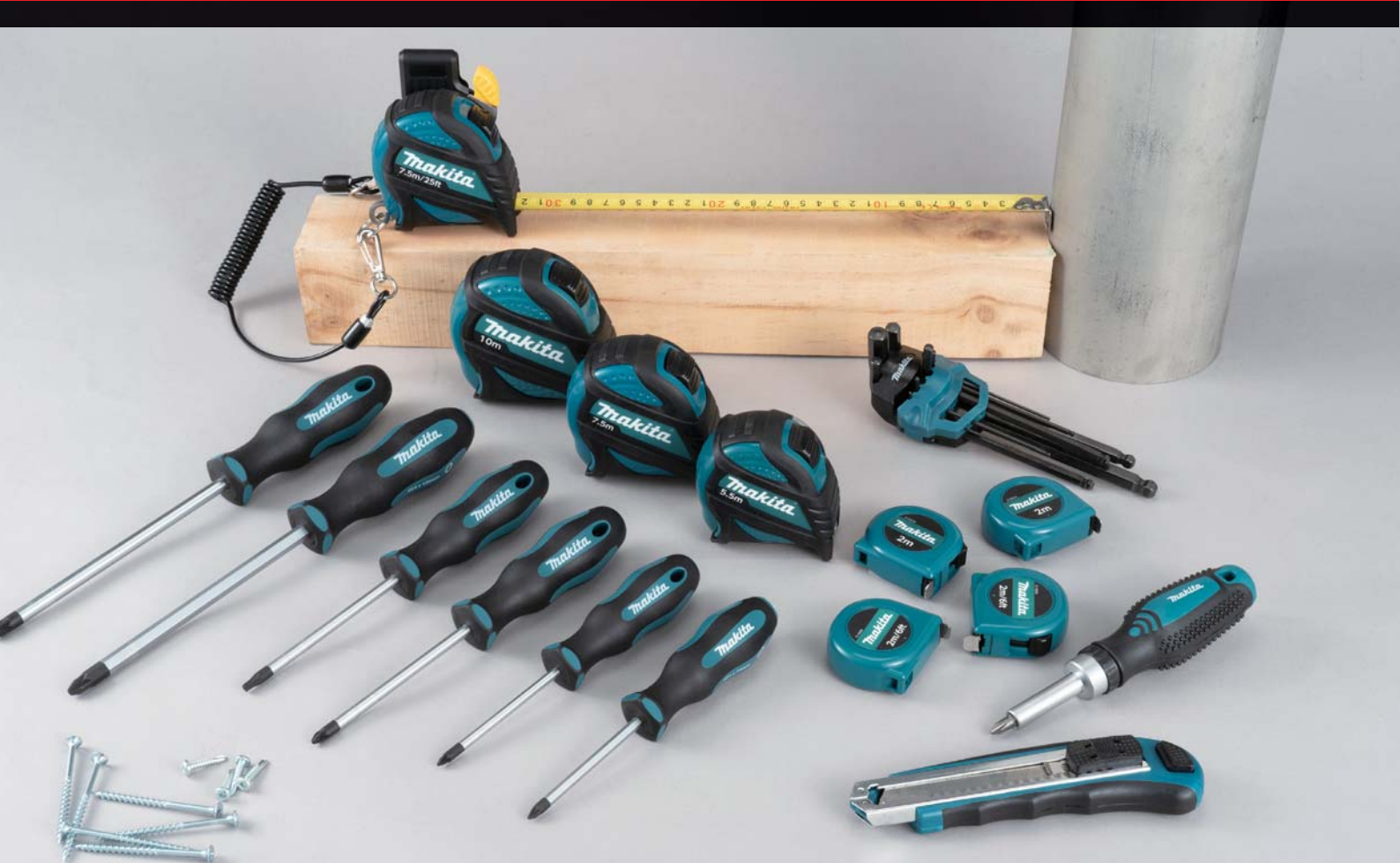

## Zvinovacie metre



### Funkcia

#### 1. Špeciálny náter

- \* „DURA COAT“ je 5-krát odolnejší
- \* „SILICA COAT“ možnosť písania



#### 2. Vysoká odolnosť háčika

- \* Inštalovaný doraz, tlmí nárazy háčika
- \* Chránič háčika znižuje otrasy háčika
- \* Pevne uchytенý háčik štyrmi nitmi s chráničom



#### 3. Výhody

- \* Obojstranná podtlač
- \* Háčik s magnetom
- \* Matný povrch, uľahčuje čítanie stupnice pri ostrom svetle
- \* Výsuv bez zalomenia



## Zvinovacie metre



Jednotka	Dĺžka	Šírka	Obj. č.	MOC s DPH
cm	2m	13mm	E-03078	6,19 €



Jednotka	Dĺžka	Šírka	Obj. č.	MOC s DPH
cm	3,5 m	16 mm	B-57130	10,49 €
cm	5,5 m	25 mm	B-57146	19,99 €
cm	7,5 m	25 mm	B-57152	27,99 €
cm	10 m	25 mm	B-57168	29,99 €

## Skrutkovače okrúhli profil



Velkosť	Dĺžka (mm)	Obj. č.	MOC s DPH	
+	PH1	100	B-65903	5,59 €
	PH2	100	B-65919	7,09 €
	PH3	150	B-65931	7,59 €
+	PZ1	80	B-65947	4,69 €
	PZ2	100	B-65953	6,99 €
	PZ3	150	B-65969	7,99 €
*	T10	100	B-65975	4,69 €
	T15	100	B-65981	4,79 €
	T20	100	B-65997	5,79 €
	T25	100	B-66008	5,39 €
-	T30	100	B-66014	6,49 €
	SL4.0	100	B-66020	4,49 €
	SL5.5	100	B-66036	5,79 €
	SL6.5	125	B-66042	6,99 €
SL8	150	B-66058	7,59 €	

## Skrutkovače hranatý profil



Velkosť	Dĺžka (mm)	Obj. č.	MOC s DPH	
+	PH1	75	B-66064	5,49 €
*	PZ1	75	B-66092	6,29 €
	PZ2	100	B-66101	6,39 €
	PZ3	150	B-66117	10,49 €

### Sady ručných skrutkovačov

E-10528 32,99 € (MOC s DPH)

PH1, PH2, PZ1, PZ2, SL4, SL5,5  
KS. / bal. – 6



### Sady ručných skrutkovačov

E-10534 28,99 € (MOC s DPH)

T10, T15, T20, T25, T30  
KS. / bal. – 5



## Nárazový skrutkovač

Makita nárazový skrutkovač je veľmi účinný na povoľovanie poškodených alebo zalomených skrutiek



### Použitie

1. Držte pevne skrutkovač pri použití

2. Silným úderom kladiva povolte skrutku

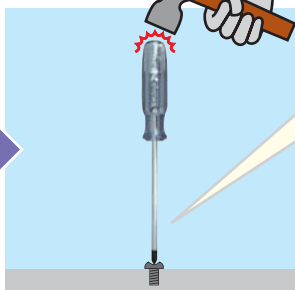
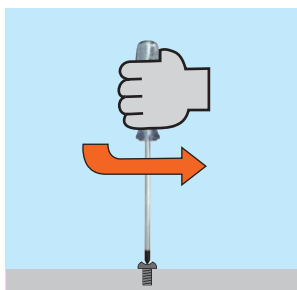

Nárazový skrutkovač dokáže odstrániť skrutky s poškodenou alebo úplne zničenou hlavičkou. Úderom kladiva na rukoväť sa vytvorí krútiaci moment smere otáčania, takže je možné skrutky s poškodenou alebo úplne zničenou hlavičkou.



\*Úderom na rukoväť sa vytvára 12 stupňový krútiaci moment v smere povoľovania, čo umožní povoliť poškodenú skrutku

12 degrees

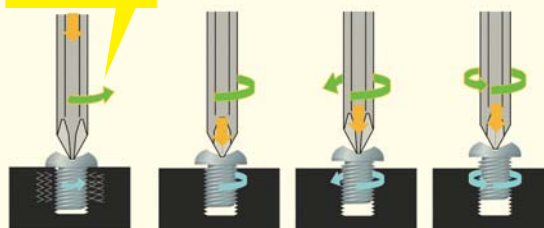

Veľkosť		Dĺžka (mm)	Obj. č.	MOC s DPH
+	PH2	125	B-42438	19,99 €
	PH3	150	B-42444	21,29 €
*	PZ2	125	B-42450	20,99 €
	PZ3	150	B-42466	21,29 €

## Sada imbusových kľúčov 9ks



Veľkosť	Obj. č.	MOC s DPH
1,5, 2, 2,5, 3, 4, 5, 6, 8, 10mm	B-65894	11,99 €

# SPONY PRE PREPRAVNÉ KUFRE

model	kufor	spona	MOC s DPH	model	kufor	spona	MOC s DPH
1050DWA	824544-4	417059-4	0,18 €	6317DWDRE	183763-4	417724-5	0,85 €
1806B	821137-8			6327DWE	824635-1	186347-7	0,85 €
1902	182113-0			6328DWE	824635-1	186347-7	0,85 €
1923H	182113-0			6337DWDESP	183763-4	417724-5	0,89 €
2012NB	824002-0			6347DWDESP	183763-4	417724-5	0,89 €
2107FK	824728-4	163455-1	1,43 €	6380	824744-6		
3612/C	P-38314			6381DWAE	824852-3	163455-1	1,43 €
3620	P-38314			6390	824744-6		
3901	824540-2	417059-4	0,18 €	6391DWAE	824853-1	163455-1	1,43 €
4112HS	824697-9	163467-4	2,09 €	6391DWALE	824853-1	163455-1	1,43 €
4304	824809-4			6503DWDE	824635-1	186347-7	0,85 €
4304T	824809-4			6704DW	824380-8		
4305	824809-4			6800DBV	824700-6		
4305T	824809-4			6802DBV	824700-6		
4326	824572-9	186347-7	0,85 €	6805DBV	824700-6		
4327	824572-9	186347-7	0,85 €	6822	824700-6		
4329	824572-9	186347-7	0,85 €	6824	824449-8		
4350CT/FCT	824809-4			6825R	824449-8		
4351CT/FCT	824809-4			6826	824449-8		
4604DW	824556-7	416401-6	2,44 €	6827	824449-8		
5103R	P-15942			6830	824421-0		
5604R	824555-9			6832	824421-0		
5621RDWA	824533-9	417075-6	3,96 €	6833	824421-0		
5704R	824555-9			6834	824421-0		
6016DW	824723-4			6842	824808-6	163455-1	1,43 €
6017DWE	824723-4			6844	824808-6	163455-1	1,43 €
6018DWE	824723-4			6904VH	824439-1		
6019DWE	824723-4			6905B	824698-7		
6019DWE	824723-4			6905H	824698-7		
6095DWE	824723-4			6906	182604-1		
6095DWE	824723-4			6908DWA	824635-1	186347-7	0,85 €
6096DWE	824723-4			6914DWA	824635-1	186347-7	0,85 €
6096DWE	824723-4			6915DWA	824549-4	186347-7	0,85 €
6204DWAE	824653-1	186347-7	0,85 €	6916DWA	824635-1	186347-7	0,85 €
6207DWDE	183763-4	417724-5	0,89 €	6918DWA	824635-1	186347-7	0,85 €
6214DWAE	824635-1	186347-7	0,85 €	6918FDWDE	824635-1	186347-7	0,85 €
6221DWE	824715-3	186347-7	0,85 €	6934FDWDE	824635-1	186347-7	0,85 €
6222DWE	824715-3	186347-7	0,85 €	6935FDWDE	824635-1	186347-7	0,85 €
6223DWE	824510-1	186347-7	0,85 €	6936FDWDE	154902-3		
6226DWE	824635-1	186347-7	0,85 €	6940DW	824686-4		
6227DWE	824635-1	186347-7	0,85 €	6951	824439-1		
6228DWE	824635-1	186347-7	0,85 €	6953	824630-1	186347-7	0,85 €
6261DWE	824853-1	163455-1	1,43 €	6960DWA	824635-1	186347-7	0,85 €
6261DWLE	824853-1	163455-1	1,43 €	6980FDWDE	824710-3	417724-5	0,89 €
6271DWAE	824853-1	163455-1	1,43 €	8271DWAE	824853-1	163455-1	1,43 €
6271DWALE	824581-8			8281DWAE	824853-1	163455-1	1,43 €
6271DWPE	824853-1	163455-1	1,43 €	8281DWAET2	149504-3		
6281DWAE	824853-1	163455-1	1,43 €	8281DWALE	824853-1	163455-1	1,43 €
6281DWALE	824581-8			8381DWAE	824852-3	163455-1	1,43 €
6314DWAE	824635-1	186347-7	0,85 €	8391DWAE	824853-1	163455-1	1,43 €

# SPONY PRE PREPRAVNÉ KUFRE

model	kufor	spona	MOC s DPH	model	kufor	spona	MOC s DPH
8391DWALE	824853-1	163455-1	1,43 €	BHP441RFE	824754-3	417724-5	0,89 €
8413DWDE	824626-2	450909-0	0,26 €	BHP442RFE	824774-7	417724-5	0,89 €
8414DWFE	824626-2	450909-0	0,26 €	BHP450RFE	824753-5	417724-5	0,89 €
8433DWDE	824626-2	450909-0	0,26 €	BHP451RFE	824754-3	417724-5	0,89 €
8434DWFE	824626-2	450909-0	0,26 €	BHP452RFE	824774-7	417724-5	0,89 €
8443DWDE	824626-2	450909-0	0,26 €	BHP453SHE	824862-0	163455-1	1,43 €
9554NB	824736-5			BDF / BHP456	141856-3	162302-3	0,59 €
9555NB	824736-5			BHR162RFE	824815-9	417724-5	0,89 €
9557HN	188627-7			BHR200SF	824690-3	417152-4	0,49 €
9558HNK	188627-7			BHR200SJE	824690-3	417152-4	0,49 €
9562CH/CVH	188627-7			BHR202RFE	824861-2	163455-1	1,43 €
9564H	188627-7			BHR240	824771-3	163455-1	1,43 €
9565CR/CVR	188627-7			BHR241RFE	824771-3	163455-1	1,43 €
9565CLR	188627-7			BHR261RDE/TRDE	824874-3	162271-8	1,07 €
9565H	188627-7			BJR181RFE	824760-8	163455-1	1,43 €
9566CR/CVR	188627-7			BJS101RFE	824899-7	163455-1	1,43 €
AF505	HY00000090			BJS130RFE	824756-9	417059-4	0,18 €
AN450H	824792-5			BJV140RFE	824775-5	450909-0	0,26 €
AN510H	824793-3			BJV180RFE	824775-5	450909-0	0,26 €
AN610H	824490-1			BO4555/4556	824806-0		
AN620H	824490-1			BO4557	824806-0		
AN621	824582-6			BO4565/4566	824806-0		
AN711H	824792-5			BO5030	824562-2		
AN911H	824792-5			BO5031	824562-2		
AN943K	824841-8			BO6040	824591-5	417059-4	0,18 €
BCS550RFE	824802-8	163455-1	1,43 €	BPB180RFE	824766-6	163467-4	2,09 €
BDA340RFE	824851-5	163455-1	1,43 €	BPT350RFE	824863-8		
BDA341RFE	824851-5	163455-1	1,43 €	BSS500RFE	824802-8		
BDA350Z	824816-7	163455-1	1,43 €	BSS610RFE	824757-7	163455-1	1,43 €
BDA351Z	824816-7	163455-1	1,43 €	BTD123F	824710-3	417724-5	0,89 €
BDF343SHE	824862-0	163455-1	1,43 €	BTD130FRFE	824753-5	417724-5	0,89 €
BDF430F	824710-3	417724-5	0,89 €	BTD132RFE	140058-8	417724-5	0,89 €
BDF440RFE	824753-5	417724-5	0,89 €	BTD133RFE	140058-8	417724-5	0,89 €
BDF441RFE	824754-3	417724-5	0,89 €	BTD140RFE	824753-5	417724-5	0,89 €
BDF442RFE	824774-7	417724-5	0,89 €	BTD200SH	824593-1	417075-6	3,96 €
BDF450RFE	824753-5	417724-5	0,89 €	BTL060RFE	824816-7	163455-1	1,43 €
BDF451RFE	824754-3	417724-5	0,89 €	BTL061RFE	824816-7	163455-1	1,43 €
BDF452RFE	824774-7	417724-5	0,89 €	BTP130RFE	824753-5	417724-5	0,89 €
BDF453SHE	824862-0	163455-1	1,43 €	BTP140RFE	824753-5	417724-5	0,89 €
BFR440RFE	824756-9	417059-4	0,18 €	BTW200SH	824593-1	417075-6	3,96 €
BFR540RFE	824807-8	163455-1	1,43 €	BTW250RFE	824753-5	417724-5	0,89 €
BFR550RFE	824807-8	163455-1	1,43 €	BTW251RFE	824753-5	417724-5	0,89 €
BFR750RFE	824807-8	163455-1	1,43 €	BTW450RFE	824777-1	163467-4	2,09 €
BFS230F	824710-3	417724-5	0,89 €	BUC122RFE	824820-6	163455-1	1,43 €
BFS440Z	824756-9	417724-5	0,89 €	BVR450RFE	824768-2	417383-5	0,37 €
BFS450Z	824756-9	417724-5	0,89 €	DA302D	824627-0	186347-7	0,85 €
BGA450RFE	824767-4	163455-1	1,43 €	DA312D	824627-0	186347-7	0,85 €
BGA452RFE	824767-4	163455-1	1,43 €	DA312DWAE	824627-0	186347-7	0,85 €
BHP343SHE	824862-0	163455-1	1,43 €	DA391DW	824627-0	186347-7	0,85 €
BHP440RFE	824753-5	417724-5	0,89 €	DA392D	824627-0	186347-7	0,85 €

Akumulátory  
Odkladacie systémy  
Vrtanie  
Skrutkovanie  
Brúsky  
Pílenie  
Frézovanie  
Brúsenie  
Klince / spony  
Špeciálne stroje  
Vysávanie  
Fény/lampy  
Záhada  
Ručné náradie  
Ostatné

# SPONY PRE PREPRAVNÉ KUFRE

model	kufor	spona	MOC s DPH	model	kufor	spona	MOC s DPH
DA400LR	824646-6	163467-4	2,09 €	HM1202C	824564-8	163467-4	2,09 €
DA6300	181791-3			HM1203C	824876-9	162271-8	1,07 €
DA6301	181791-3			HM1213C	824908-2	162271-8	1,07 €
DBM080	P-45135			HM1214C	824882-4	162271-8	1,07 €
DBM130	P-45141			HM1303	182714-4		
DF010DSE	824781-0	417724-5	0,89 €	HM1303B	182851-4		
DF030DWE	824842-6	417724-5	0,89 €	HM1304	183567-4		
DF330DWE	824842-6	417724-5	0,89 €	HM1304B	183598-3		
DK1150	E02248-2			HM1307C	824898-9		
DK1867	824774-7	417724-5	0,89 €	HM1307CB	824898-9		
DP3003	824595-7	417059-4	0,18 €	HM1317C	824897-1		
DP4001	824595-7	417059-4	0,18 €	HP1620K	824724-2		
DP4003	824595-7	417059-4	0,18 €	HP1621K	824724-2		
DP4010	P-04101			HP1630K	824811-7	417724-5	0,89 €
DP4011	P-04101			HP1631K	824811-7	417724-5	0,89 €
DP4700	P-04101			HP1640K	824724-2		
FS2700	824890-5			HP1641K	824724-2		
GA4530	188627-7			HP1830	821896-4	417724-5	0,89 €
GA5030	188627-7			HP2030	824485-4		
GA7010C	824878-5	163455-1	1,43 €	HP2031	824485-4		
GA7020	824878-5	163455-1	1,43 €	HP2050	821896-4	417724-5	0,89 €
GA7030	824878-5	163455-1	1,43 €	HP2051	821896-4	417724-5	0,89 €
GA7040	824878-5	163455-1	1,43 €	HP2051F	821896-4	417724-5	0,89 €
GA9010C	824878-5	163455-1	1,43 €	HP2070	821896-4	417724-5	0,89 €
GA9020	824878-5	163455-1	1,43 €	HP2071	821896-4	417724-5	0,89 €
GA9020SFK	824878-5	163455-1	1,43 €	HP2071F	821896-4	417724-5	0,89 €
GA9030	824878-5	163455-1	1,43 €	HR160DWA	824550-9	417059-4	0,18 €
GA9040	824878-5	163455-1	1,43 €	HR1830	821896-4	417724-5	0,89 €
HG5002K	HG118897			HR2010	824464-2	186347-7	0,85 €
HG5012K	HG118897			HR2020	821896-4	417724-5	0,89 €
HG550VK	HG118897			HR2230	824799-1	417724-5	0,89 €
HG551VK	HG118897			HR2400	824445-6		
HG650CK	HG118897			HR2410	824445-6		
HG651CK	HG118897			HR2430	824575-3	417059-4	0,18 €
HK0500	824523-2	163455-1	1,43 €	HR2431	824575-3	417059-4	0,18 €
HK1810	150640-5	417059-4	0,18 €	HR2432	824729-2	163455-1	1,43 €
HK1820	824789-4	417724-5	0,89 €	HR2440	821896-4	417724-5	0,89 €
HM0810	150879-0	417383-5	0,37 €	HR2450	821896-4	417724-5	0,89 €
HM0810T	150879-0	417383-5	0,37 €	HR2450T	824695-3		
HM0870C	824905-8			HR2460	824799-1	417724-5	0,89 €
HM0871C	824904-0			HR2470	824799-1	417724-5	0,89 €
HM1100	150676-4	416401-6	2,44 €	HR2470T	824799-1	417724-5	0,89 €
HM1100C	150676-4	416401-6	2,44 €	HR2600	141856-3	162302-3	0,59 €
HM1101C	140561-9			HR2650/2651	141856-3	162302-3	0,59 €
HM1111C	140561-9			HR2800	824789-4	417724-5	0,89 €
HM1130C	150676-4	163467-4	2,09 €	HR2810	824789-4	417724-5	0,89 €
HM1140C	150676-4	163467-4	2,09 €	HR2810T	824789-4	417724-5	0,89 €
HM1200	150583-1	163467-4	2,09 €	HR2811F	824789-4	417724-5	0,89 €
HM1200B	150586-5	163467-4	2,09 €	HR2811FT	824789-4	417724-5	0,89 €
HM1200K	150583-1	163467-4	2,09 €	HR3000C	824559-1	163467-4	2,09 €

# SPONY PRE PREPRAVNÉ KUFRE

model	kufor	spona	MOC s DPH	model	kufor	spona	MOC s DPH
HR3200C	824819-1	163467-4	2,09 €	JR3030	824539-7	417059-4	0,18 €
HR3210C	824825-6	163467-4	2,09 €	JR3030T	824539-7	417059-4	0,18 €
HR3210FCT	824825-6	163467-4	2,09 €	JR3050T	824734-9	417724-5	0,89 €
HR3520	150597-0	163467-4	2,09 €	JR3060T	824734-9	417724-5	0,89 €
HR3540C	824819-1	163467-4	2,09 €	JR3070CT	824734-9	417724-5	0,89 €
HR3541FC	824819-1	163467-4	2,09 €	JS3200	181797-1		
HR3550C	824559-1	163467-4	2,09 €	KP0810	824786-0		
HR3850	150582-3	163467-4	2,09 €	KP0810C	824786-0		
HR3850K	150582-3	163467-4	2,09 €	LCT304	824842-6		
HR4000C	824479-9	416401-6	2,44 €	MEU041	824888-2		
HR4001C	158693-8	163467-4	2,09 €	NHP1300S	824700-6		
HR4002	824798-3	163467-4	2,09 €	PC1100	181789-0		
HR4010C	158691-2	163467-4	2,09 €	PC5000C	140073-2		
HR4011C	158692-0	163467-4	2,09 €	SC130DRA	SC08100910		
HR4500C	824607-6	163467-4	2,09 €	SG1250	824709-8	163455-1	1,43 €
HR4501C	158274-8	163467-4	2,09 €	SG150	B50856		
HR4510C	158275-6	163467-4	2,09 €	SKR60	LM.400.02		
HR4511C	158273-0	163467-4	2,09 €	SKR301	ZA.023.0M		
HR5001C	824519-3	163467-4	2,09 €	SP6000K	824783-6		
HR5201C	158274-8	163467-4	2,09 €	T221DW	183771-5		
HR5210C	158275-6	163467-4	2,09 €	TD020DSE	831272-4		
HR5211C	158273-0	163467-4	2,09 €	TD090DWE	824842-6	417724-5	0,89 €
824961-8	HS300D			TW0200	824703-0	186347-7	0,85 €
JN3200	181797-1			TW0350	824702-2	186347-7	0,85 €
JR1000FTK	824722-6	417059-4	0,18 €	TW1000	824737-3	416401-6	2,44 €
JR180DWD	824565-6	417152-4	0,49 €	UC120DWAE	824491-9	417059-4	0,18 €
JR3000V	824539-7	417059-4	0,18 €	VR250DWAE	824486-2		
JR3000VT	824539-7	417059-4	0,18 €	VR250DWDE	824486-2		
JR3020	824539-7	417059-4	0,18 €				

Akumulátory  
 Odkladacie systémy  
 Vrtanie  
 Skrutkovanie  
 Brúsky  
 Pílenie  
 Frézovanie  
 Brúsenie  
 Klince / spony  
 Špeciálne stroje  
 Vysávanie  
 Fény/lampy  
 Záhrada  
 Ručné náradie  
 Ostatné

model	obj. číslo	model	obj. číslo	model	obj. číslo	model	obj. číslo	model	obj. číslo
446L	W49625*	6822	CB-419	BDA341	CB-448	BGA450	CB-430	BTW200	CB-441
447L	W49625*	6823	CB-419	BDA350	CB-448	BGA452	CB-430	BTW250	CB-448
448	80051B5X*	6824	CB-419	BDA351	CB-448	BGD800	CB-430	BTW251	CB-448
906	CB-64	6825R	CB-419	BDF440	CB-448	BHP440	CB-448	BTW450	CB-441
1806B	CB-153	6826	CB-419	BDF441	CB-448	BHP441	CB-448	BUB360	CB-430
1902	CB-51	6827	CB-419	BDF442	CB-448	BHP442	CB-448	BUC122	CB-430
1911B	CB-106	6842	CB-411	BDF444	CB-448	BHP444	CB-448	BUC250	CB-442
1923H	CB-132	6844	CB-411	BDF446	CB-448	BHP446	CB-448	BUH550	CB-442
2012NB	CB-153	6904VH	CB-415	BDF448	CB-448	BHP448	CB-448	CA5000	CB-303
2107FK	CB-303	6905B	CB-65	BDF450	CB-448	BHP450	CB-448	DA3010F	CB-419
2414EN	CB-203	6905H	CB-415	BDF451	CB-448	BHP451	CB-448	DA3011F	CB-419
2414NB	CB-203	6906	CB-100	BDF452	CB-448	BHP452	CB-448	DA4000LR	CB-303
2704	CB-153	6916FD	CB-431	BDF454	CB-448	BHP454	CB-448	DA6301	CB-100
3612C	CB-203	6918FD	CB-434	BDF456	CB-448	BHP456	CB-448	DBM080	EE7332022S**
3612	CB-203	6934FD	CB-434	BDF458	CB-448	BHP458	CB-448	DBM130	EE7332022S**
3620	CB-106	6935FD	CB-434	BFL060FZ	CB-434	BHR162	CB-430	DBM230	EE7332022S**
3706	CB-64	6936FD	CB-434	BFL061FZ	CB-434	BHR200	CB-430	DBN500	CB-448
3707	CB-411	6951	CB-411	BFL080FZ	CB-434	BHR202	CB-441	DCO180	CB-430
3708	CB-411	6953	CB-411	BFL081FZ	CB-434	BHR240	CB-430	DCS550	CB-430
3709	CB-411	6980FD	CB-434	BFL082FZ	CB-434	BHR241	CB-441	DDA340	CB-448
3710	CB-411	7104L	CB-153	BFL120FZ	CB-434	BHR261	CB-442	DDA341	CB-448
3901	CB-411	8414D	CB-430	BFL122FZ	CB-434	BHR262	CB-442	DDA350	CB-448
4101RH	CB-303	8434D	CB-430	BFL200FZ	CB-434	BHS630	CB-441	DDA351	CB-448
4105KB	CB-100	8444D	CB-430	BFL201FZ	CB-434	BJN161	CB-430	DDF446	CB-448
4112HS	CB-204	9031	CB-411	BFL201RZ	CB-434	BJR181	CB-411	DDF448	CB-448
4131	CB-303	9032	CB-411	BFL202FZ	CB-434	BJS101	CB-430	DDF456	CB-448
4157KB	CB-153	9046	CB-419	BFL300FZ	CB-434	BJS130	CB-448	DDF458	CB-448
4326	CB-64	9079SF	CB-204	BFL301FZ	CB-434	BJV140	CB-430	DDF482	CB-448
4327	CB-64	9207SPB	CB-100	BFL301RZ	CB-434	BJV180	CB-430	DFR440	CB-448
4329	CB-64	9227CB	CB-303	BFL400FZ	CB-434	BKP180	CB-441	DFR540	CB-448
4350	CB-419	9237CB	CB-303	BFL402FZ	CB-434	BLS713	CB-441	DFR550	CB-448
4351	CB-419	9403	CB-303	BFL402RZ	CB-434	BO3700	CB-64	DFR750	CB-448
5014/5016	CB-403	9404	CB-303	BFR440	CB-448	BO3710	CB-64	DFS440	CB-448
5017RKB	CB-303	9541/9542	CB-302	BFR540	CB-448	BO3711	CB-64	DFS450	CB-448
5103R	CB-203	9554/55NB	CB-325	BFR550	CB-448	BO4555	CB-419	DFS451	CB-448
5104S	CB-203	9557/58	CB-325	BFR750	CB-448	BO4556	CB-419	DGA450	CB-430
5143R	CB-203	9562CH/CVH	CB-318	BFS440	CB-448	BO4557	CB-419	DGA452	CB-430
5603R	CB-303	9562CR	CB-318	BFS441	CB-448	BO4565	CB-419	DGD800	CB-430
5604R	CB-303	9562CVH	CB-318	BFS450	CB-448	BO4900V	CB-419	DHP446	CB-448
5704R	CB-303	9562CVR	CB-318	BFS451	CB-448	BO5021	CB-64	DHP448	CB-448
5705R	CB-303	9564H	CB-325	BFT020FZ	CB-434	BO5030	CB-419	DHP456	CB-448
5903R	CB-203	9565C/CV	CB-318	BFT022FZ	CB-434	BO5031	CB-419	DHP458	CB-448
6013B	CB-51	9565CLR	CB-318	BFT040FZ	CB-434	BO5041	CB-64	DHP482	CB-448
6207D	CB-430	9565CR	CB-318	BFT041FZ	CB-434	BO6030	CB-419	DHR162	CB-430
6300-4	CB-51	9565CVL	CB-318	BFT041RZ	CB-434	BO6040	CB-318	DHR164	CB-430
6305	CB-303	9565CVR	CB-318	BFT042FZ	CB-434	BO6050	CB-325	DHR165	CB-430
6317D	CB-430	9565H	CB-325	BFT043FZ	CB-434	BPB180	CB-430	DHR202	CB-441
6319D	CB-430	9565HZ1	CB-325	BFT044FZ	CB-434	BPJ180	CB-430	DHR241	CB-441
6337D	CB-430	9565PCV	CB-318	BFT080FZ	CB-434	BSS500	CB-430	DHR263	CB-442
6339D	CB-430	9566C/CV	CB-318	BFT082FZ	CB-434	BSS501	CB-430	DHR264	CB-442
6347D	CB-430	9566CR	CB-318	BFT082RZ	CB-434	BSS610	CB-411	DHS630	CB-441
6349D	CB-430	9566CVR	CB-318	BFT083FZ	CB-434	BTD130	CB-448	DHS710	CB-442
6408	CB-419	9741	CB-100	BFT084FZ	CB-434	BTD134	CB-448	DJN161	CB-430
6412	CB-64	9903	CB-303	BFT122FZ	CB-434	BTD140	CB-448	DJR181	CB-411
6413	CB-64	9910/11	CB-411	BFT123FZ	CB-434	BTD146	CB-448	DJS101	CB-430
6501X	CB-70	9920	CB-303	BFT124FZ	CB-434	BTP130	CB-448	DJS130	CB-448
6501	CB-70	9924DB	CB-100	BFT124RZ	CB-434	BTP140	CB-448	DJV140	CB-430
6510LVR	CB-64	BCS550	CB-430	BFT125FZ	CB-434	BTP141	CB-448	DJV180	CB-430
6821	CB-419	BDA340	CB-448	BFT126FZ	CB-434	BTS130	CB-448	DKP180	CB-441



model	obj. číslo	model	obj. číslo	model	obj. číslo	model	obj. číslo	model	obj. číslo
DLS713	CB-441	GA7063R	CB-218	HP2070	CB-419	JS3200	CB-100	TW0350	CB-411
DP2010	CB-419	GA7070/7071	191T31-1	HP2071	CB-419	JS3201	CB-303	TW1000	CB-153
DP2011	CB-419	GA9010	CB-204	HR1830	CB-419	JV0600	CB-64	UB1101	CB-303
DP3003	CB-419	GA9020	CB-204	HR2010	CB-105	KC100	CB-203	UB1103	CB-303
DP4001	CB-419	GA9030	CB-204	HR2230	CB-325	KP0800	CB-411	UB360D	CB430
DP4003	CB-419	GA9040	CB-204	HR2300	CB-325	KP0810	CB-132	UC250D	CB442
DP4010	CB-419	GA9050	CB-204	HR2432	CB-419	KP0810C	CB-132	UC3020A	CB-132
DP4011	CB-419	GA9060R	CB-218	HR2450	CB-419	KP312S	CB-203	UC3030A	181044-0*
DP4700	CB-64	GA9061R	CB-218	HR2460	CB-325	LC1230	CB-203	UC3041A	CB-132
DPB180	CB-430	GA9062R	CB-218	HR2470	CB-325	LF1000	CB-153	UC3051A	CB-153
DPJ180	CB-430	GA9063R	CB-218	HR2600	CB-325	LH1040	CB-153	UC3520A	CB-132
DS4010	CB-411	GA9070/9071	191T31-2	HR2610	CB-325	LH1200FL	JM23300083*	UC3530A	181044-0*
DS4011	CB-411	GD0600	CB-325	HR2611	CB-325	LH1201FL	JM23000123*	UC3541A	CB-132
DSC191	CB-448	GD0601	CB-325	HR2630	CB-325	LS0714	CB-303	UC3551A	CB-153
DSS500	CB-430	GD0602	CB-325	HR2630T	CB-325	LS0714FL	CB-303	UC4020A	CB-132
DSS610	CB-411	GD0603	CB-64	HR2631F	CB-325	LS0815FL	JM23500117	UC4030A	181044-0*
DTD134	CB-448	GD0800C	CB-318	HR2631FT	CB-325	LS1013	CB-153	UC4041A	CB-132
DTD146	CB-448	GD0801C	CB-318	HR2641	CB-325	LS1013L	CB-153	UC4051A	CB-153
DTD152	CB-448	GD0810C	CB-318	HR2800	CB-325	LS1016	CB-153	UC4530A	181044-0*
DTP141	CB-448	GD0811C	CB-318	HR2810	CB-325	LS1016L	CB-153	UC4551A	CB-153
DTS130	CB-448	HB500	EIB106C*	HR2811F	CB-325	LS1018L	JM23000123*	UH4260	CB-419
DTW250	CB-448	HK0500	CB-113	HR2811FT	CB-325	LS1040	CB-153	UH4261	CB-419
DTW251	CB-448	HK1820	CB-350	HR3200C	CB-350	LS1214	CB-153	UH4570	CB-419
DTW450	CB-441	HK1820L	CB-350	HR3210C	CB-350	LS1214L	CB-153	UH4860	CB-419
DUB361	CB-430	HM0810T	CB-105	HR3210FCT	CB-350	LS1216	CB-153	UH4861	CB-419
DUC122	CB-430	HM0860C	CB-327	HR3540C	CB-350	LS1216L	CB-153	UH5260	CB-419
DVC860L	CB-353	HM0870C	CB-350	HR3541FC	CB-350	LS1440	CB-154	UH5261	CB-419
FS2300	CB-419	HM0871C	CB-350	HR4001C	CB-350	LW1400	CB-203	UH550D	CB442
FS2700	CB-419	HM1101C	CB-175	HR4002	CB-350	LW1401	CB-203	UH5540	223804410*
FS4000	CB-419	HM1111C	CB-175	HR4003C	CB-175	M6001/6002	CB-85	UH5550	957800410*
FS4300	CB-419	HM1200	CB-155	HR4011C	CB-350	M8100/8001	CB-85	UH5570	CB-419
FS6300R	CB-419	HM1200B	CB-155	HR4013C	CB-175	M8103/8104	CB-85	UH5580	CB-419
GA4530	CB-459	HM1202C	CB-155	HR4501C	CB-175	MLS100	JM23000123*	UH6350	957800410*
GA4530R	CB-459	HM1203C	CB-175	HR4510C	CB-175	MLT100X	JM23000123*	UH6540	223804410*
GA4540	CB-325	HM1205C	CB-175	HR4511C	CB-175	N1923B	CB-51	UH6570	CB-419
GA4540C01	CB-325	HM1213C	CB-175	HR5201C	CB-175	N5900B	CB-153	UH6580	CB-419
GA4540R	CB-325	HM1214C	CB-175	HR5202C	CB-175	PC1100	CB-100	UH7580	CB-419
GA4541C01	CB-325	HM1304	CB-204	HR5210C	CB-175	PC5000C	CB-253	UR3500	YA00000504*
GA4541R	CB-325	HM1304B	CB-204	HR5211C	CB-175	PC5001C	CB-253	UR3501	YA00000504*
GA4541X01	CB-325	HM1307C	CB-175	HR5212C	CB-175	PJ7000	CB-459	UT120	EE80700013**
GA5021	CB-303	HM1307CB	CB-175	HS6100/6101	CB-174	PV7000C	CB-303	UT1200	EE80700032
GA5030	CB-459	HM1317C	CB-175	HS7100/7101	CB-174	PW5000CH	CB-318	UT1305	CB-303
GA5030R	CB-459	HM1400	CB-155	HS6101	CB-147	RP0900	CB-107	UT1400	EE80700013**
GA5040	CB-325	HM1501	CB-218	HS7101	CB-147	RP0910	CB-303	UT1401	EE80700013**
GA5040C01	CB-325	HM1502	CB-218	HS7601	CB-303	RP1110C	CB-303	UT1600	EE7332022S**
GA5040R	CB-325	HM1511	CB-218	JN1601	CB-411	RP1800FX	CB-203	UT2204	CB-303
GA5041C01	CB-325	HM1512	CB-218	JN3200	CB-100	RP2300FCX	CB-203	VC2211	CB-173
GA5041R	CB-325	HM1801	CB-204	JN3201	CB-303	RT0700C	CB-411	VC3210	CB-173
GA5041X01	CB-325	HM1802	CB-218	JR1000FTK	CB-419	SA5040C	CB-318	VC3211	CB-173
GA5050/5051R	CB-260	HM1810	CB-204	JR180DWDE	CB-432	SA7000C	CB-204		
GA6021	CB-303	HM1812	CB-218	JR3050T	CB-303	SG1250	CB-318		
GA6040C01	CB-325	HP1620	CB-419	JR3060T	CB-303	SG1251J	CB-318		
GA7010C	CB-204	HP1621	CB-419	JR3070CT	CB-303	SG150	B45872**		
GA7020	CB-204	HP1630	CB-85	JS1000	CB-459	SP6000	CB-303		
GA7030	CB-204	HP1631	CB-85	JS1600	CB-65	SP6000K	CB-303		
GA7040	CB-204	HP1640	CB-419	JS1601	CB-459	TD0101F	CB-411		
GA7060R	CB-218	HP1641	CB-419	JS1602	CB-459	TM3000C	CB-459		
GA7061R	CB-218	HP2050	CB-419	JS1660	CB-65	TM3010C	CB-459		
GA7062R	CB-218	HP2051	CB-419	JS1670	CB-65	TW0200	CB-411		

\* zároveň obj. číslo; \*\* zároveň obj. číslo, iba 1 ks v balení

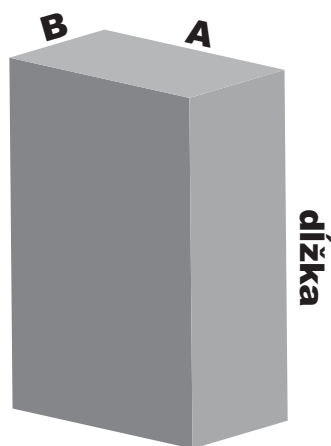

typ	obj. č.	délka	šířka A	hloubka B	MOC s DPH
CB-51	181021-2	11,8	8	5	2,29 €
CB-55	194964-9	11,7	8	5	6,29 €
CB-64	191627-8	10,8	8	5	2,39 €
CB-65	191628-6	11,7	8	5	3,59 €
CB-70	191914-5	10,8	8	5	2,99 €
CB-85	194973-8	k.A.	k.A.	k.A.	2,99 €
CB-100	181030-1	14,8	10	6	2,49 €
CB-105	181038-5	15,3	9,9	5,9	7,79 €
CB-106	194976-2	14,8	10	6	3,99 €
CB-113	194978-8	14,8	9,9	6	7,69 €
CB-132	194984-3	14,7	10	6	4,99 €
CB-153	181044-0	17,8	13,4	6,5	2,69 €
CB-154	181047-4	17,8	13,4	6,5	4,49 €
CB-155	181048-2	17,8	13,4	6,5	7,19 €
CB-173	195489-6	k.A.	k.A.	k.A.	6,49 €
CB-174	196018-8	k.A.	k.A.	k.A.	5,09 €
CB-175	195844-2	26,6	8,4	6,5	5,09 €
CB-203	194991-6	15,8	17,9	6,9	3,39 €
CB-204	194992-4	16,2	17,9	7	5,99 €
CB-218	197129-2	23,7	17,9	6,9	5,49 €
CB-251	194547-5	16,8	10,9	6,9	4,19 €
CB-253	194547-5	16,8	10,9	6,9	4,19 €
CB-260	191D85-2	k.A.	k.A.	k.A.	6,39 €
CB-302	191959-3	k.A.	k.A.	k.A.	6,99 €
CB-303	191963-2	17,8	10,9	5	2,79 €
CB-318	191978-9	15,7	10,9	5	8,49 €
CB-325	194074-2	15,8	11	4,9	2,29 €
CB-327	194285-9	16,8	11	4,9	6,29 €
CB-350	194160-9	25,3	10,9	6,5	5,59 €
CB-353	197208-6	k.A.	k.A.	k.A.	31,99 €
CB-403	191928-4	k.A.	k.A.	k.A.	6,49 €
CB-411	191940-4	11,7	8,9	6	3,29 €
CB-415	191950-1	8,7	8,9	6	4,99 €
CB-417	191955-1	9,4	8,9	6	9,19 €
CB-419	195015-1	11,3	9	6	3,99 €
CB-424	191966-6	8,7	5,3	4,8	2,99 €
CB-430	191971-3	9,7	7,2	6,9	3,29 €
CB-434	195020-8	11,8	5,8	4,9	4,29 €
CB-441	195022-4	10,8	10,8	6,9	4,99 €
CB-442	195023-2	10,8	10,7	6,9	4,49 €
CB-448	196854-2	13,3	9,9	3	3,69 €
CB-459	195026-6	12,8	8,9	6	1,99 €
	191T31-1	k.A.	k.A.	k.A.	4,29 €
B45872 (iba 1 ks)		20	9,9	6,2	16,99 €
EE7132A22S (iba 2 ks)		17,9	9,9	6,2	25,99 €
EE7332022S (iba 2 ks)		20	15,9	6,2	24,99 €
EIB106C		k.A.	k.A.	k.A.	38,99 €
JM23000123		17,3	13,4	6,5	3,59 €
W49625		32	10,9	6,3	52,99 €
JM23500117		k.A.	k.A.	k.A.	3,19 €
EE7701822S		k.A.	k.A.	k.A.	24,99 €

## VYSVETLIVKY

### 18 V / 12 V MAX program

- Z – dodávané bez akumulátora a nabíjačky
- J – dodávané v systainery
- K – dodávané v kufri
- X – extra príbal príslušenstva
- PT2 – Dvojnabíjačka /rýchlonabíjačka/, 2 ks 5,0 Ah akumulátor
- PT4 – Dvojnabíjačka /rýchlonabíjačka/, 4 ks 5,0 Ah akumulátor
- PF2 – Rýchlonabíjačka, 2 ks 3,0 Ah akumulátor
- RF – Rýchlonabíjačka, 1 ks 3,0 Ah akumulátor
- SYE – Nabíjačka, 2 ks 1,5 Ah akumulátor
- RFJ – Rýchlonabíjačka, 2 ks 3,0 Ah akumulátor, systainer
- RFE – Rýchlonabíjačka, 2 ks 3,0 Ah akumulátor
- RTE – Rýchlonabíjačka, 2 ks 5,0 Ah akumulátor
- RTJ – Rýchlonabíjačka, 2 ks 5,0 Ah akumulátor, systainer
- RF3J – Rýchlonabíjačka, 3 ks 3,0 Ah akumulátor, systainer
- RFEB – Rýchlonabíjačka, 2 ks 3,0 Ah akumulátor, čierne prevedenie stroja
- RTJV – Rýchlonabíjačka, 2 ks 5,0 Ah akumulátor, systainer, odsávacie zariadenie
- DZ – dodávané bez akumulátora a nabíjačky
- DSAE – Rýchlonabíjačka, 2 ks 2,0 Ah akumulátor
- DSME – Rýchlonabíjačka, 2 ks 4,0 Ah akumulátor

### 40 V program

- GD101 – Rýchlonabíjačka, 1 ks 2,5 Ah akumulátor
- GM101 – Rýchlonabíjačka, 1 ks 4,0 Ah akumulátor
- GT101 – Rýchlonabíjačka, 1 ks 5,0 Ah akumulátor
- GZ – dodávané bez akumulátora a nabíjačky
- GD201 – Rýchlonabíjačka, 2 ks 2,5 Ah akumulátor
- GM201 – Rýchlonabíjačka, 2 ks 4,0 Ah akumulátor
- GT201 – Rýchlonabíjačka, 2 ks 5,0 Ah akumulátor

### Označenie akumulátorov 12 / 14,4 / 18 V

- Y – 1,5 Ah
- A – 2,0 Ah
- F – 3,0 Ah
- M – 4,0 Ah
- T – 5,0 Ah
- G – 6,0 Ah



- A – 2,0 Ah
- D – 2,5 Ah
- M – 4,0 Ah
- T – 5,0 Ah

**ADT** – Automatická regulácia otáčok

**AFT** – Automatické zastavenie stroja

**DXT** – presný rez

Deep and Exact Cutting Technology

**XPT** – ochrana proti zvýšenej prašnosti a vlhkosti

EXTREME PROTECTION TECHNOLOGY

**SJST** – antivibračný systém

SUPER JOINT SYSTEM

**AWS** – prepojenie aku strojov s aku vysávačom

**AVT** – antivibračný systém

ANTI VIBRATION TECHNOLOGY

**BL MOTOR** – bezuhlíkový motor

**(BRAKE)** – brzda

## Sortiment príslušenstva



Spoločnosť Makita si vyhradzuje právo kedykoľvek vykonávať zmeny ponuky bez predchádzajúceho upozornenia. Ponuky sú k dispozícii do vypredania skladových zásob. Obrázky sú ilustračné a oproti skutočnosti sa môžu líšiť.



**Makita s. r. o.**  
Priemyselná 26  
974 01 Banská Bystrica  
Web: [www.makita.sk](http://www.makita.sk)